

RCA

RCA Series

Information
Manual

BF-000-1-00



RCA Series Information Manual

BF-000-1-00

RCA Series

Information Manual

December 1970
BF-000-1-00

Marketing Publications
Building 204-2
Cherry Hill, New Jersey

The RCA logo is located in the bottom right corner of the page. It consists of the letters 'RCA' in a bold, stylized, outlined font. The 'R' and 'C' are connected, and the 'A' is separate. The entire logo is rendered in black outlines on a white background.

The information contained herein is subject to change without notice. Revisions may be issued to advise of such changes and/or additions.

First Printing: December 1970 (BF-000-1-00)

PREFACE

The RCA Series Systems Information Manual is the introductory publication for a series of technical publications required to document the RCA Series processors, peripherals, software programming systems, and industry applications developed by the RCA Computer Systems Division in support of its most advanced computer systems – The RCA Series.

This manual presents an overview for the reader wishing a general knowledge of the hardware and software features offered in this series of RCA advanced computer equipment.

This systems information manual is divided into five parts for logical order of reference:

Part 1 – The RCA Series Processors – presents a concise description and pictorial presentation of the RCA 2 and 3, and the RCA 6 and 7 Processors outlining their salient functions, features, and system architecture. Included is the publications plan for the support of this advanced technology.

Part 1 ■

Part 2 – The RCA Series Peripherals – presents a general description and pictorial presentation of the peripheral environment (devices), arranged by media-handling capability, that can be configured with the RCA Series processors. A publications plan is provided for additional support information requirements.

Part 2 ■

Part 3 – Operating System 70 (OS/70) – presents a general description of the OS/70 control and operating environments for both the RCA 2 and RCA 6 Processors. The software publications plan outlining each support component is provided.

Part 3 ■

Part 4 – Virtual Memory Operating System (VMOS) – presents a general description of VMOS, virtual memory concepts, control and operating environments for both the RCA 3 and RCA 7 Processors. The software publications plan outlining each support component is provided.

Part 4 ■

Part 5 – Industry Applications – presents a general description of many of the industry applications available for the RCA Series. These industry applications packages are designed to give a total spectrum of support to the RCA Series systems users. A publication plan is also presented.

Part 5 ■

Although extreme care has been taken to ensure a general audience acceptance, assumptions are that the reader is familiar with third generation information processing terminology and system concepts.

CONTENTS

| | Page |
|---|------|
| PART 1 – THE RCA SERIES PROCESSORS | |
| Introduction | 1-1 |
| RCA Series Hardware | 1-1 |
| RCA Series Software | 1-1 |
| Equipment Colors | 1-2 |
| Section 1: RCA SERIES PROCESSOR ORGANIZATION | |
| General | 1-3 |
| Program Control | 1-5 |
| Character Code | 1-6 |
| Data Formats | 1-6 |
| Addressing Scheme | 1-7 |
| Instruction Formats | 1-7 |
| Memory Organization | 1-8 |
| Virtual Memory Concept | 1-11 |
| Interval Timer | 1-11 |
| Elapsed Time Clock | 1-11 |
| Section 2: INSTRUCTION REPERTOIRE | |
| General | 1-13 |
| Arithmetic Instructions | 1-13 |
| Logical Instructions | 1-16 |
| Branching Instructions | 1-18 |
| Processor State Control Instructions | 1-19 |
| Privileged Mode Instructions | 1-19 |
| Special Functions | 1-20 |
| Section 3: SPECIAL PROCESSOR FEATURES | |
| General | 1-23 |
| Direct Control | 1-23 |
| Emulators | 1-23 |
| Selector Channels | 1-23 |
| Run Time Recorder Interface | 1-23 |
| Memory Expansion | 1-24 |

Section 4: RCA SERIES PROCESSOR SUMMARY

| | |
|-------------------------------------|------|
| General | 1-25 |
| Model RCA 2 <i>7.0/45</i> | 1-25 |
| Model RCA 3 <i>7.0/46</i> | 1-27 |
| Model RCA 6 | 1-29 |
| Model RCA 7 | 1-31 |

| | |
|--|------|
| Section 5: PUBLICATIONS PLAN FOR RCA SERIES PROCESSORS | 1-33 |
|--|------|

PART 2 – THE RCA SERIES PERIPHERALS

| | |
|------------------------|-----|
| Introduction | 2-1 |
|------------------------|-----|

Section 1: CONSOLE DEVICES

| | |
|--|-----|
| General | 2-3 |
| Model 8091 Video Operator Console and 8092 Auxiliary Console | 2-3 |
| Model 8093 Console Printer | 2-5 |
| Model 8094 Console Card Reader | 2-5 |
| Model 8097-020 Console | 2-6 |

Section 2: PAPER TAPE DEVICES

| | |
|--|------|
| General | 2-9 |
| Model 8221 Paper Tape Reader/Punch | 2-9 |
| Model 8224 Paper Tape Reader | 2-11 |
| Model 8227 Paper Tape Reader/Punch | 2-12 |

Section 3: CARD AND MICR DEVICES

| | |
|--|------|
| General | 2-13 |
| Model 8232 Card Reader | 2-13 |
| Model 8234 Card Punch | 2-14 |
| Model 8236 Card Punch | 2-15 |
| Model 8237 Card Reader | 2-16 |
| Model 8272 MICR Sorter-Reader Controller | 2-17 |

Section 4: PRINTING DEVICES

| | |
|---|------|
| General | 2-19 |
| Model 8242 Medium Speed Printer | 2-19 |
| Model 8243 Hi-Speed Printer | 2-21 |
| Model 8244 Train Printer | 2-24 |
| Model 8248 Bill Feed Printer | 2-25 |
| Model 8249 Bill Feed Printer Controller | 2-26 |

Section 5: MAGNETIC TAPE DEVICES

| | |
|--|------|
| General | 2-27 |
| Model 8432 Magnetic Tape Unit | 2-27 |
| Model 8442 Magnetic Tape Unit | 2-29 |
| Model 8445 Magnetic Tape Station | 2-30 |
| Model 8451 Magnetic Tape Unit | 2-32 |
| Model 8453 Magnetic Tape Unit | 2-33 |
| Model 8457 Magnetic Tape Station | 2-34 |
| Model 8459 Magnetic Tape Station | 2-35 |
| Model 8472 Tape Controller | 2-36 |
| Model 8473 Tape Controller | 2-37 |
| Model 8476 Tape Controller | 2-38 |
| Model 8478 Tape Controller | 2-39 |

Section 6: RANDOM ACCESS DEVICES

| | |
|--|------|
| General | 2-41 |
| Model 8551 Random Access Controller | 2-41 |
| Model 8560 Virtual Memory Storage System | 2-43 |
| Model 8564 Disc Storage Unit | 2-44 |
| Model 8567 Drum Memory Unit | 2-45 |
| Model 8568 Mass Storage Unit | 2-46 |
| Model 8590 Direct Access Storage System | 2-47 |

Section 7: SWITCHING DEVICES

| | |
|--|------|
| General | 2-49 |
| Model 8310 Standard Interface Switch | 2-50 |
| Communication Line Switches | 2-52 |
| Model 8325-002 Telegraph Line Switch | 2-56 |
| Model 8326-002 Data Set Switch Unit | 2-58 |
| Model 8326-003 Data Set Switch Unit | 2-59 |
| Model 8350 Switch Controller | 2-60 |
| Model 8356 Communication Line Switch Adapter | 2-61 |

Section 8: COMMUNICATION CONTROLS

| | |
|--|------|
| General | 2-63 |
| Model 8510 Voice Response Unit | 2-64 |
| Model 8627 Data Exchange Control | 2-67 |
| Model 8653 Communication Control | 2-68 |
| Model 8656 Communication Controller – Single Channel | 2-70 |
| Model 8660 Front End Communications Processor | 2-72 |
| Model 8668 Communication Controller – Multichannel | 2-73 |

Section 9: COMMUNICATION BUFFERS

| | |
|---|------|
| Model 8610 Telegraph Buffer | 2-77 |
| Model 8612 Telegraph Low Level Buffer | 2-78 |
| Model 8615 Telegraph Parallel Buffer | 2-78 |
| Model 8617 Parallel Data Set Buffer | 2-78 |
| Model 8620 Asynchronous Data Set Buffer | 2-79 |
| Model 8621 Synchronous Data Set Buffer | 2-80 |
| Model 8680 Time Generator/Buffer | 2-81 |

| | Page |
|--|-------|
| Section 10: TERMINALS AND ASSOCIATED DEVICES | |
| General | 2-83 |
| Modular Video Data System | 2-83 |
| Model 8751 Video Data Terminal | 2-84 |
| Model 8756 Video Data Generator | 2-84 |
| Model 8759 Video Data Controller | 2-86 |
| Stand-Alone Video Data Terminals | 2-87 |
| Model 8752-100 Video Data Terminal | 2-87 |
| Model 8752-200 Video Data Terminal | 2-89 |
| Model 8755-100 Video Data Switch | 2-92 |
| Model 8755-200 Data Terminal Switch | 2-93 |
| Section 11: OTHER TERMINAL DEVICES | |
| Model 8740 Data Terminal | 2-95 |
| Model 8741 Card Reader | 2-97 |
| Model 8762 Data Terminal | 2-97 |
| Model 6701 Data Terminal Coupler | 2-100 |
| Model 6711 Data Set | 2-102 |
| Model 6740, 6741, and 6742 Teletypewriters | 2-104 |
| Model 6750, 6751, and 6752 Teletypewriters | 2-106 |
| Model 6793 Power Supply | 2-108 |
| Section 12: PUBLICATIONS PLAN FOR RCA SERIES PERIPHERAL DEVICES | |
| General | 2-109 |
| PART 3 – OPERATING SYSTEM (OS/70) | |
| Introduction | 3-1 |
| Section 1: OPERATING SYSTEM 70 (OS/70) OVERVIEW | |
| General | 3-3 |
| Section 2: SYSTEM COMPONENTS | |
| General | 3-5 |
| Control System | 3-5 |
| Language System | 3-5 |
| Data Management System | 3-5 |
| Utility System | 3-5 |
| Communications System | 3-6 |
| Emulation and Conversions System | 3-6 |
| Data Base Management System | 3-6 |

Section 3: SYSTEM FUNCTIONS

| | |
|---|------|
| General | 3-7 |
| Job Management | 3-7 |
| Data Management | 3-8 |
| Program Preparation | 3-9 |
| Program Execution | 3-12 |
| Input/Output Spooling | 3-13 |
| Systems Generation and Initialization | 3-13 |

Section 4: PUBLICATIONS PLAN FOR OPERATING SYSTEM 70 OS/70

| | |
|-------------------|------|
| General | 3-15 |
|-------------------|------|

PART 4 – VIRTUAL MEMORY OPERATING SYSTEM (VMOS)

| | |
|------------------------|-----|
| Introduction | 4-1 |
|------------------------|-----|

Section 1: VMOS PROGRAM ORGANIZATION

| | |
|---|-----|
| General | 4-3 |
| VMOS Control Components | 4-3 |
| Interactive Language Facilities | 4-4 |

Section 2: BATCH PROCESSING FACILITIES

| | |
|--|-----|
| Batch Processing | 4-7 |
| Remote Batch Processor | 4-7 |
| Non-Interactive Source Language Processors | 4-7 |

Section 3: VMOS SERVICE ROUTINES

| | |
|--|------|
| General | 4-9 |
| Display Program | 4-9 |
| Dump Charting Programs | 4-9 |
| Hardware Check Routines | 4-9 |
| Linkage Editor | 4-10 |
| Dynamic Linking Loader | 4-10 |
| Sort/Merge | 4-10 |
| Library Routines | 4-10 |
| Peripheral Conversion Routines | 4-10 |
| Recovery/Restart Facilities | 4-10 |
| System Maintenance Routines | 4-11 |
| Output Routines | 4-11 |

Section 4: COMMUNICATIONS FACILITIES

| | |
|-----------------------------------|------|
| General | 4-13 |
| Devices Supported | 4-13 |
| Terminal/Line Functions | 4-14 |

| | Page |
|--|-------------|
| Section 5: VMOS APPLICATIONS PROGRAMS | |
| General | 4-15 |
| AUTOFORM | 4-15 |
| Section 6: VMOS SUMMARY | 4-17 |
| Section 7: PUBLICATIONS PLAN FOR VMOS | 4-19 |

PART 5 – INDUSTRY APPLICATIONS

| | |
|---|------|
| Introduction | 5-1 |
| Section 1: BANKING | |
| RCA Banking Applications | 5-3 |
| New Concepts in Computer Banking Applications | 5-4 |
| Section 2: INSURANCE | |
| General | 5-7 |
| Data Base Maintenance | 5-7 |
| Underwriting | 5-7 |
| Rating | 5-7 |
| Policy Issue | 5-7 |
| Policy Inquiry | 5-7 |
| General Accounting | 5-8 |
| Sales | 5-8 |
| Group Insurance, Group Annuities, and Pension Trust | 5-8 |
| Claim Processing | 5-8 |
| Alpha-Index | 5-8 |
| Actuarial Processing | 5-8 |
| Section 3: UTILITIES | |
| General | 5-9 |
| Customer Service – Order Entry and Inquiry | 5-9 |
| Engineering | 5-10 |
| Inventory Management | 5-10 |
| Work Order Accounting | 5-10 |
| Payroll and Personnel | 5-10 |
| Section 4: TELEPHONE | |
| General | 5-11 |
| Customer Service | 5-11 |
| Number Services | 5-12 |
| Trunks and Special Services | 5-12 |
| Time Sharing | 5-13 |

| | Page |
|--|-------------|
| Section 5: MANUFACTURING | |
| General | 5-15 |
| Order Processing | 5-15 |
| Forecasting and Inventory Control | 5-15 |
| Engineering Data Control | 5-15 |
| Requirements Generation | 5-16 |
| Production Scheduling and Control | 5-16 |
| Information For An Informed Management | 5-16 |
| Section 6: GOVERNMENT | |
| General | 5-17 |
| Law Enforcement | 5-17 |
| Legislative and Administrative | 5-17 |
| Health and Welfare | 5-18 |
| Transportation | 5-18 |
| Employment Security | 5-20 |
| City-County | 5-20 |
| Section 7: EDUCATION | |
| General | 5-23 |
| Instructional Systems | 5-23 |
| Administrative Efficiency | 5-23 |
| Section 8: MEDICAL FIELD | |
| General | 5-25 |
| Applications | 5-25 |
| Inquiry/Response | 5-26 |
| Section 9: MANAGEMENT SCIENCE | |
| General | 5-27 |
| Linear Programming | 5-27 |
| Statistical Library | 5-28 |
| SSS/70 | 5-28 |
| Project Management | 5-28 |
| Numerical Control | 5-28 |
| Time Sharing Library (RCA 3 and 7) | 5-28 |
| Simulation | 5-28 |
| Flow Simulator | 5-28 |
| SIMSCRIPT-SIM II PLUS | 5-29 |
| Integrated Civil Engineering Systems (ICES) | 5-29 |
| Section 10: PUBLICATIONS PLAN FOR APPLICATION PROGRAMS | 5-31 |
| APPENDICES | |
| A – Extended Binary Coded Decimal Interchange Code (EBCDIC) | A-1 |
| B – American National Standard Code for Information Interchange (ANSII) | B-1 |
| C – Magnetic Tape Interchangeability | C-1 |
| D – RCA 2, 3, 6, and 7 Configurator | D-1 |
| E – Communications Configurator | E-1 |
| F – RCA 6701 Data Terminal Configurations | F-1 |

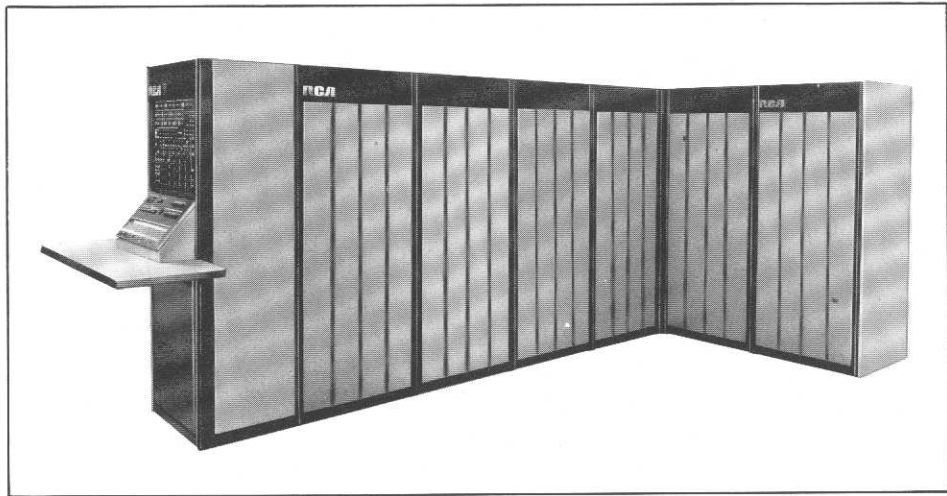
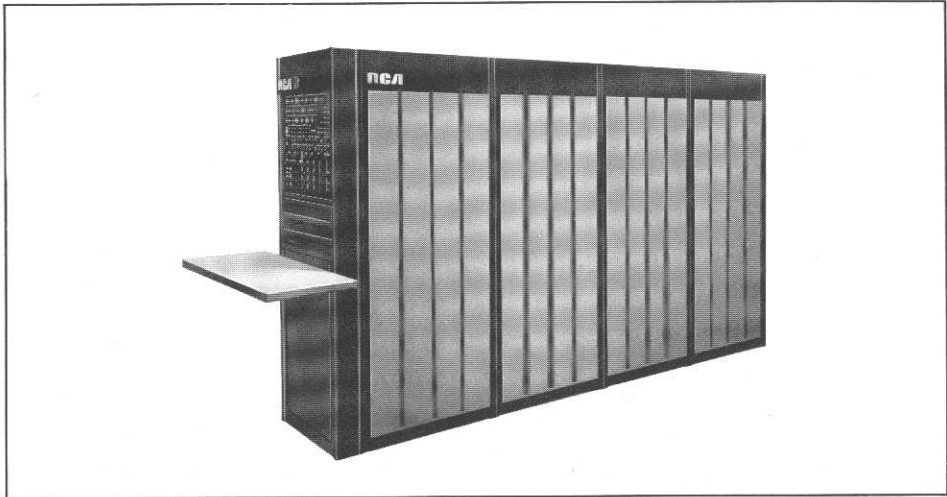

The RCA Series Processors

INTRODUCTION

The RCA Series — RCA 2, RCA 3, RCA 6, and RCA 7 Processors — is a highly flexible family of compatible computer systems. A wide selection of processor capability and peripherals provides for configuring systems to meet the requirements of users in all areas of commercial, scientific, control, communications, and interactive time-sharing applications. Hardware is supported by software operating systems with system compatibility providing for ease of growth to larger systems or to adapt newly developed equipment to accommodate the changes in user requirements.

RCA SERIES HARDWARE

The RCA Series consists of a group of processors which cover the range of main memory sizes from 65,000 bytes to over two million bytes. Memory cycle speeds range from 1440 nanoseconds down to 765 nanoseconds. Simultaneous input/output and processing capability are provided on all series models to obtain maximum system efficiency. Peripheral operations are accomplished through input/output channels and standard processor interfaces to which a variety of peripheral devices may be attached. Up to six processors, including unlike models, may be configured to operate in a multiple-processor environment. Two models, the RCA 3 and RCA 7 are designed for efficient operation in the batch processing and interactive time-sharing environment.

The RCA Series peripheral devices are offered in a wide and expanding range of speeds and functional capabilities. A standard interface with common peripheral coupling provides for great flexibility in the selection of devices and for ease in expanding an existing system to include additional state-of-the-art devices. The communications controls, buffers, switches, and terminal equipment offer a full range of advanced communications equipment for the fast-growing data communications area. Additional information on the RCA Series peripheral environment is contained in subsequent sections of this manual.

RCA SERIES SOFTWARE

Various programming aids traditionally have been provided to facilitate common basic tasks of information processing such as program preparation, execution, testing, and maintenance. Advanced technology and a widening range of applications now require that increased attention be given to a more complete and systematic approach to these tasks for greater operating efficiency. With the announcement of the RCA OS/70 and VMOS systems, overhead has been minimized while system effectiveness has been expanded.

The RCA Series programming systems provide comprehensive and flexible programming support for the processors within the RCA Series. A number of programming systems are provided to permit the selection of that system most appropriate to the needs of the installation or application. These include Operating System 70 (OS/70), Virtual Memory Operating System (VMOS), and User-Application Programs.

The Virtual Memory Operating System (VMOS) provides concurrent processing for both interactive and batch users. The system has a separate command language for both the Executive Control and Data Management functions.

A complement of RCA Series User-Application Programs is available. These applications are addressed toward user problems and include both total systems and subroutines, where the specific application cannot be defined as a total system due to its general use in conjunction with user-defined problems.

Details of the various software packages for the RCA Series Systems are described in this manual.

EQUIPMENT COLORS

The RCA Series systems are available in various colors which are compatible with any interior decoration scheme. Reference should be made to the RCA Color Selection Guide to assist in system designs. This guide can be obtained at the nearest RCA District or Sales office.

Section 1: RCA SERIES PROCESSOR ORGANIZATION

GENERAL

The RCA Series processors and peripheral equipment provide a wide and expanding selection of advanced information processing system capabilities. The RCA 2, 3, 6, and 7 Systems provide convenient growth both within a particular system or to a larger system. Uniformity in the processor and its relationship to the peripheral environment interface are maintained throughout the RCA Series. This interfacing facilitates attachment of any existing or future peripheral device to all RCA Processors. The RCA Series also provides software compatibility over a broad range of performance levels. Standards are maintained throughout the series while still providing for a wide choice of capabilities in processor and peripheral configuration. For system efficiency and programming ease, all RCA Series processors are designed to run under control of an operating system. The operating system used is a function of the system configuration and system application.

The general arrangement of an RCA Series system is shown in figure 1-1. The basic processing unit executes the program and communicates with the peripheral devices by way of the selector and multiplexor channels. An input/output operation once initiated by the program, functions as a separate processing operation, to control the exchange of data between main memory and the peripheral device by way of the device controller. Once an input/output operation is started, the processing unit is free to perform other tasks. The input/output (selector or multiplexor) channel relieves the processing unit of the task of controlling the comparatively slow input/output operation. The selector channels handle devices which have a high-data transfer rate; for example, magnetic drums, magnetic discs, magnetic tape. The multiplexor channels handle lower transfer rate devices; for example, control console, printer, card equipment, and communication devices.

The input/output standard interface is the same regardless of the type of peripheral equipment or model of processor. All processors have a multiplexor channel and may be equipped with from one to six selector channels; the maximum number depends on the particular processor model. The device controllers are connected to the channel trunks through the standard interface cables (figure 1-2). Each channel trunk accommodates one device controller which may in turn control one or several devices depending on the type of device. In some cases the device controller is integral to the device.

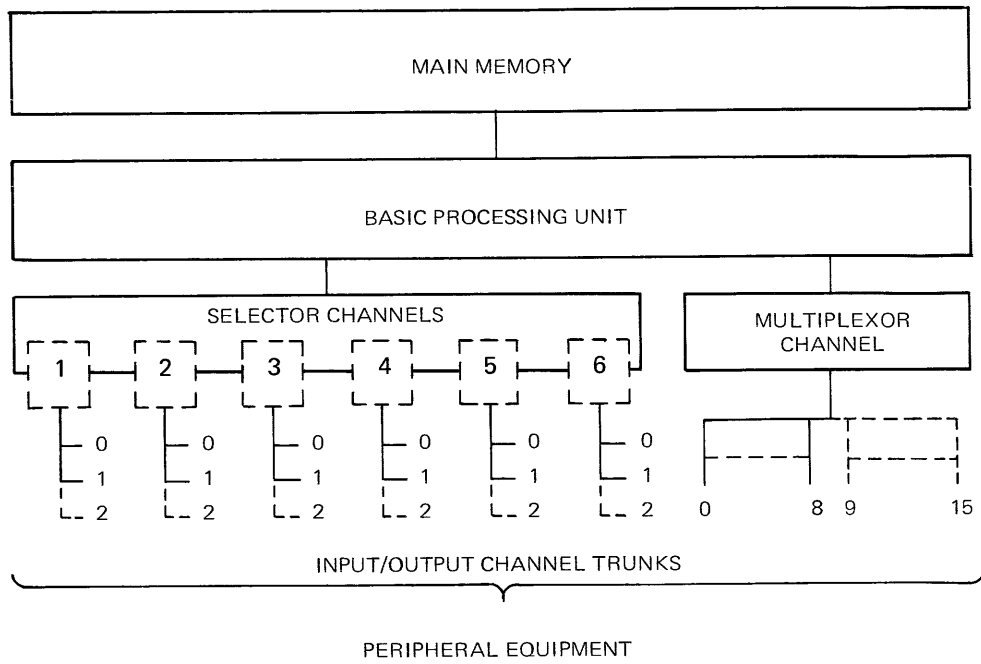

FIGURE 1-1. GENERAL ARRANGEMENT OF RCA SERIES SYSTEM

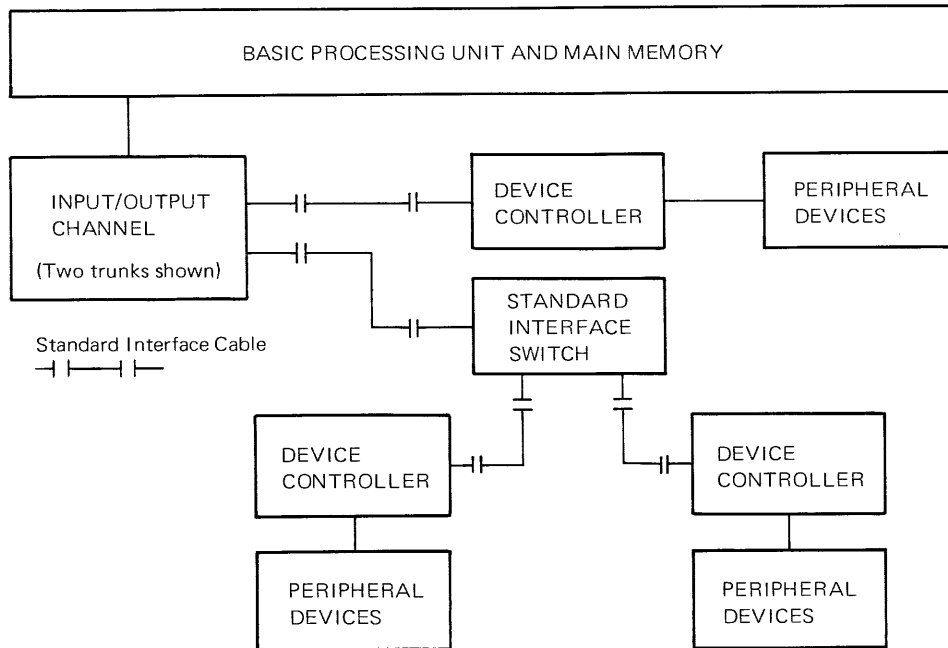

FIGURE 1-2. PERIPHERAL DEVICE TO PROCESSOR ATTACHMENT

A standard interface switch is available which permits more than one device controller to be attached to a trunk but only electrically connected to the trunk when the switch is so positioned. The standard interface switch may be either manually or program controlled. The maximum number of trunks per selector channel is two or three depending on the processor model. The number of multiplexor channel trunks ranges from 9 to 16 depending on the processor. Up to 256 peripheral devices can be connected to one multiplexor channel.

Remote peripheral devices which communicate with the processor over communication lines, for example telephone lines, are controlled by way of a communication controller. The communication controller connects from a multiplexor channel trunk through a buffer to the communication line.

The type of communication controller and buffer required is a function of the system requirements and type of communication line.

PROGRAM CONTROL

The RCA Series Processors operate under control of an operating system. To a user program, the operating system and processor hardware are not distinguishable. The operating system for a particular site is tailored at the time of installation by selecting from a master systems tape all those program units which will be applicable to the equipment complement and system requirements of that installation. This selection or system generation is accomplished with a program which is also supplied with the configuration of the system to be generated and other applicable parameters.

During normal operation, the processor, by way of an interrupt system notifies the operating system of conditions which require servicing. These interrupts may be peripheral devices requiring servicing, programming error, mathematical error, parity error, another processor in a multiple-processor system, or a processor malfunction. The processor responds to an interrupt by changing states to provide the operating system with the information required to analyze the cause of the interrupt. Once the operating system determines the cause of the interrupt, the processor again changes states and enters an operating system routine which services the interrupt condition. The number of conditions causing an interrupt will vary depending on the system configuration, special features installed, and processor model. There are 32 possible interrupt conditions; three of which are implemented only in a virtual memory system.

User programs are executed in the processing state designated as P_1 . Any interrupt condition (except a hardware malfunction) causes the processor to enter the interrupt control state designated as P_3 . The interrupt is analyzed in the P_3 state by operating system routines. From the appropriate P_3 routine, the interrupt response state, P_2 , is entered.

If the interrupt is caused by a hardware malfunction, or power transient, the processor enters processing state P_4 and, depending on the cause of the interrupt and the processor model, error recovery or shutdown routines may be initiated. A set of registers associated with each of the four processor states is built into a hardware fast memory. Thus, the processor can change quickly from one state to another without storing a large amount of data required for program control.

CHARACTER CODE

The RCA Series uses the Extended Binary Coded Decimal Interchange Code (EBCDIC) but offers facilities for generating and using the American National Standard Code for Information Interchange (ANSII). (Refer to Appendices A and B respectively.) The setting of a control bit in the processor determines whether the EBCDIC or ANSCII mode is in effect.

DATA FORMATS

The basic unit of all formats is an 8-bit byte. A ninth odd parity bit is transmitted with each byte but is used only by the hardware for error detection and is ignored in this description of data formats. The successive sizes of fixed-length data are byte, halfword (two bytes), word (four bytes), and doubleword (eight bytes) as shown in figure 1-3. The length of variable-length data is indicated by a length field within instruction.

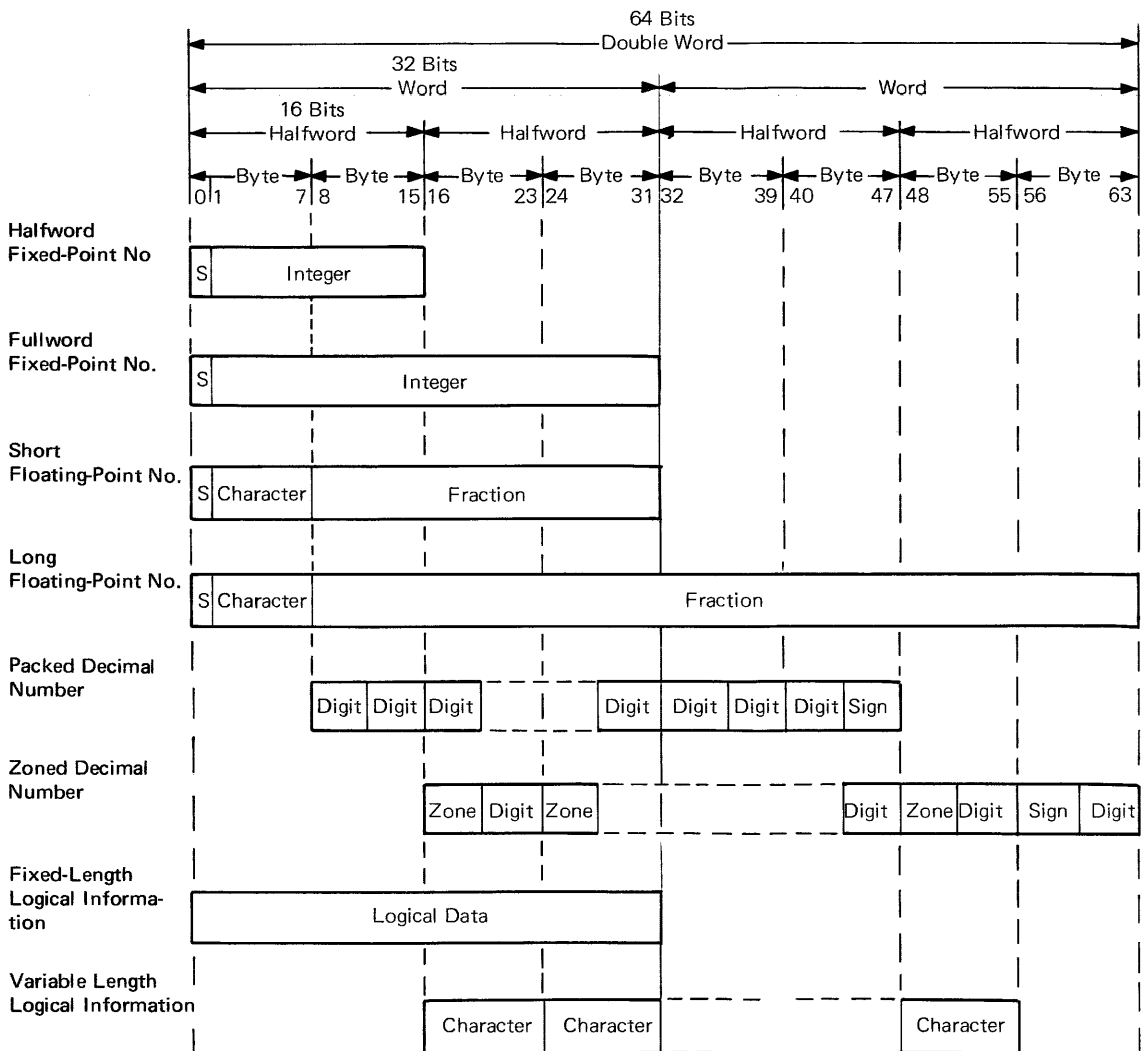

FIGURE 1-3. DATA FORMATS

ADDRESSING SCHEME

The RCA Series uses a two-part memory addressing system consisting of a base address and a displacement address. The base address is used to address a 4096-byte increment of memory. The displacement address is used to address the individual byte within the 4096-byte increment. The displacement address is added to the base address to yield the final address. A third (index) factor may also be added to the displacement and base addresses in certain instructions. The displacement address is 12 bits (4096) for all modes.

INSTRUCTION FORMATS

The RCA Series processors use five different instruction formats of two, four, or six bytes each, as shown in table 1-1. These five formats provide for efficient addressing of data in the general registers and/or in memory and for modifying addresses as required.

TABLE 1-1. INSTRUCTION FORMATS

| Format | Op Code | R ₁ /M | R ₂ | | | | | | | | | | | |
|--------|---------|-------------------|----------------|----------------|----------------|----------------|----------------|----|----|----|----|----|----|----|
| RR | Op Code | R ₁ /M | R ₂ | | | | | | | | | | | |
| RS | Op Code | R ₁ /M | R ₃ | B ₂ | D ₂ | | | | | | | | | |
| RX | Op Code | R ₁ /M | X ₂ | B ₂ | D ₂ | | | | | | | | | |
| SI | Op Code | I ₂ | | B ₁ | D ₁ | | | | | | | | | |
| SS | Op Code | L | | B ₁ | D ₁ | B ₂ | D ₂ | | | | | | | |
| | | L ₁ | L ₂ | | | | | | | | | | | |
| | 0 | 7 | 8 | 11 | 12 | 15 | 16 | 19 | 20 | 31 | 32 | 35 | 36 | 47 |

B₁ register containing base address of 1st operand.

B₂ register containing base address of 2nd operand.

D₁ displacement address of 1st operand.

D₂ displacement address of 2nd operand.

I₂ operand (immediate) contained within instruction.

R₁ register containing 1st operand.

R₂ register containing 2nd operand.

R₃ register containing 3rd operand.

X₂ register containing index attribute.

L eight bit operand length designator.

L₁,L₂ four bit operand length designators.

M masks which specify the condition codes to be tested in specific branching instructions

MEMORY ORGANIZATION

Main Memory

Main memory is the processor storage area which contains the instructions of the operating system, the user program, and the data being processed. Main memory is the magnetic-core type in sizes which vary within the RCA Series processor models. Main memory units in RCA Series processors are modular in concept and located external to the processor main frame. The distance from the memory to the processor is limited to 20 feet for the RCA Series 2 and 3 Processors, but may exceed this figure for the RCA 6 and 7 Processors, in which case, a delay of 85 nanoseconds is added to the memory cycle time (that is, above 1,048,576 bytes the memories will operate at 850 nanoseconds cycle time).

Main memory size is described in number of bytes of capacity where each byte consists of eight binary digits (bits) plus one parity digit. The smallest addressable unit in main memory is the byte.

Main memory cycle time and the number of bytes accessed with each cycle are also a function of the individual processor model. Cycle time is the time required to transfer the accessed byte/s from main memory to the memory register and to regenerate the bytes in main memory, since the information is destroyed in the reading process.

Memory Switching Concept

Memory switching is an important concept in the RCA Series processors which permits the addition or subtraction of memory modules. Actual switching techniques and configurations are explained in detail in the RCA Series processors reference and operating manuals, and the installation planning guides. An example of a typical configuration is shown in figure 1-4.

The following example will typify the principles involved. An installation has two 524KB RCA 6's. The user wants to switch one bank of 262KB on processor "A" to processor "B", but not from "B" to "A". The configuration is as follows:

| | |
|--------|----------------------|
| 2 each | 8006-002 |
| 1 each | 5074 (Processor "A") |
| 1 each | 5076 (Processor "B") |
| 4 each | 8000-015 |

Note that only Processor "B" has the capability of a 786KB memory since 262KB is added to its 524KB (Feature 5076).

It should also be noted that when switching memory from processor to processor and when the address ranges are changed, the processor(s) must be stopped and the initial start up procedures initiated.

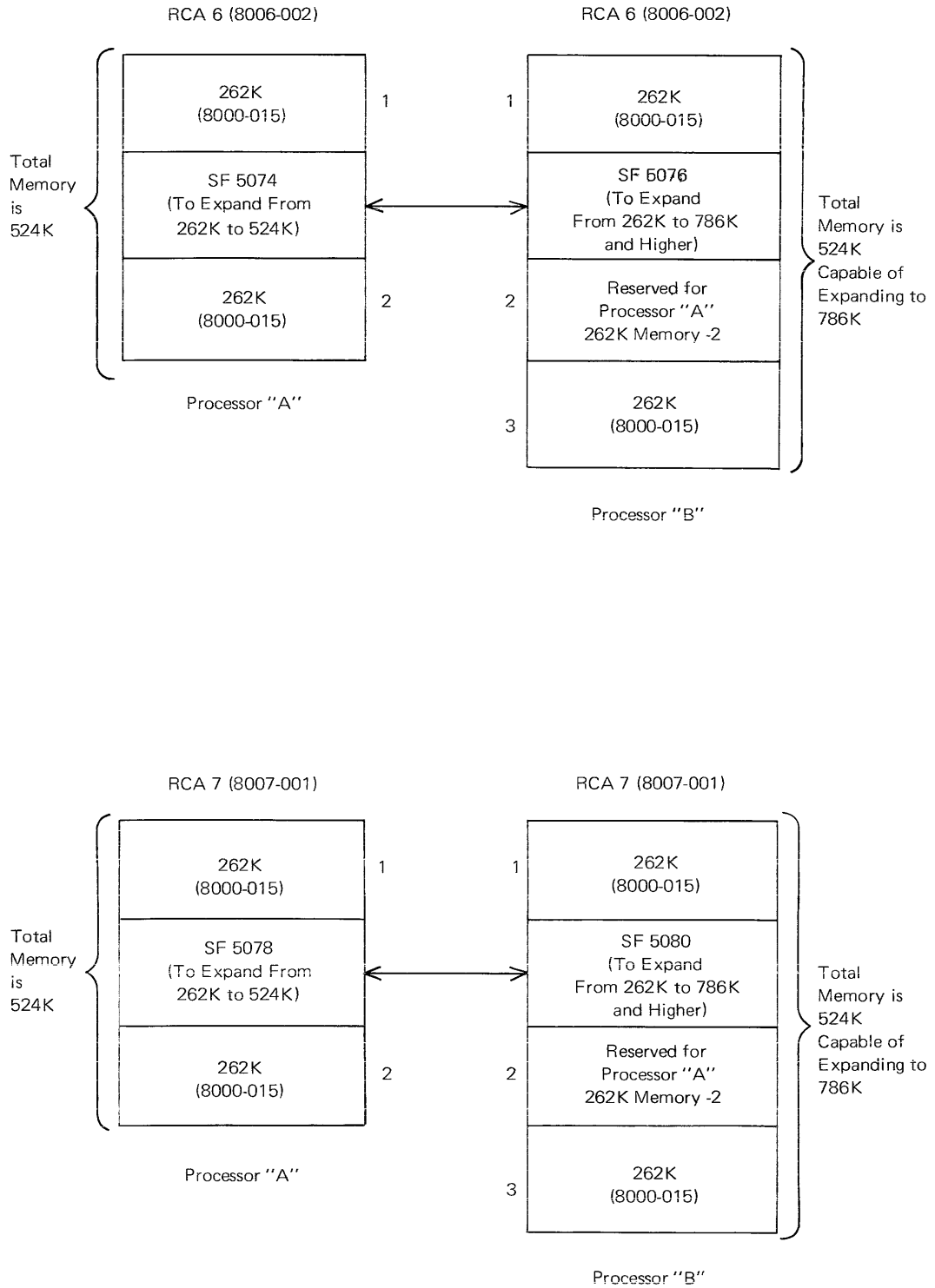

FIGURE 1-4. TYPICAL MEMORY SWITCHING CONFIGURATION FOR THE RCA 6 AND RCA 7.

Memory Protection

This feature provides both read and write protection for the entire main memory of the processor. Memory protection is implemented with two 4-bit keys which must match to allow access to the protected area. A storage key is associated with each 2048-byte block of memory. A protection key is associated with each processor state and each input/output channel. When an instruction calls for accessing memory, the protection key, supplied by the program, is compared with the storage key and if they match, or either key is zero, access to the protected area is permitted. If the keys do not match, an address error interrupt occurs. Two privileged instructions, Set Storage Key and Insert Storage Key, are used to implement memory protection. Instruction execution time is not affected by this protection.

Read-Only Memory

The read-only memory is the wired-in logic memory that determines the elementary operations which the processor will perform to execute the program instructions. The length, number of words, and cycle time of the read-only memory vary among processor models. Processors with the Emulator special feature have extra read-only memory to accomplish the Emulator functions. Processors designed for time-sharing applications also have extra read-only memory to execute special functions associated with the translation memory, content-addressable memory, and the interval timer portion of these processors.

Fast Memory

The processors use a fast memory also known as scratchpad which contains the working registers that provide internal control and input/output control for the processor. The type of fast memory used and the speed of this memory varies among processor models. In addition to the registers used for processor control, fast memory also contains the general-purpose and floating-point registers which are available to the user programmers. Two privileged instructions, Load Scratchpad and Store Scratchpad, provide access to this memory. All models incorporate this special fast memory.

Nonaddressable Main Memory

Nonaddressable main memory is an extension of main memory used by the hardware to store information for each device connected on the multiplexor channel. The size and speed of nonaddressable main memory vary with the processor models.

Shaded Main Memory

With the Model RCA 6 and 7 Processors, the memory which stores the registers for the devices on the multiplexor channel can be accessed and is designated as shaded main memory. A 4096-byte module of shaded main memory accompanies each 131 kilobyte (KB) module of main memory on these processors. The shaded main memory of the first 131KB module of the first 262KB bank is used by the hardware for storage of the sets of registers for the devices on the multiplexor channel, and for storage of error detection

and recovery data. Two privileged instructions provide for addressing shaded main memory. These instructions are: Load Shaded Memory and Store Shaded Memory.

VIRTUAL MEMORY CONCEPT

Virtual memory is a conceptual form of memory which the programmer uses without regard for real physical storage locations. The virtual memory consists of page increments which may reside in main memory or in subsidiary storage according to the needs of the program being executed.

Translation Memory – RCA 3

The RCA 3 Processor uses a translation memory to implement a virtual memory for the user. The location of virtual memory pages, whether in real or virtual storage, is maintained by a translation table and other tables established by the operating system. The translation memory decodes the translation table entries to provide page addresses.

The Function Call privileged instruction with special functions is used by the operating system to access the translation memory.

Content-Addressable Memory – RCA 7

The RCA 7 Processor uses a content-addressable memory in conjunction with a three-level address translation scheme to implement a virtual memory for the user. This multiple-level scheme uses block tables, segment tables, and page tables, maintained in main memory by the operating system.

The Function Call privileged instruction with special functions, is used by the operating system to access this content-addressable memory.

INTERVAL TIMER

The RCA 3 and 7 Processors incorporate an interval timer to provide timed increments which are used by the operating system. The interval timer is set by the privileged instruction, Function Call, and a special function.

ELAPSED TIME CLOCK

The elapsed time clock provides a program interrupt after a programmable interval of 1 millisecond has expired.

GENERAL

This section presents the instruction repertoire available to the systems programmer or application programmer for programming the RCA 2, RCA 3, RCA 6, and RCA 7 processors. Instructions are presented in logical groupings of functional usage for ease of reference; the format notations, operand designations and addressing capabilities are assumed from reading of Section 1.

Although an understanding of machine instructions is desirable, the applications programmer will, in most cases, use these instructions via RCA standard language processors.

ARITHMETIC INSTRUCTIONS

Fixed-Point Arithmetic Instructions

These instructions provide the means for performing fixed-point binary arithmetic on operands which are fixed-point data, addresses, index quantities, or counts. The formats employed for fixed-point arithmetic instructions are as follows:

Formats RR and RX:

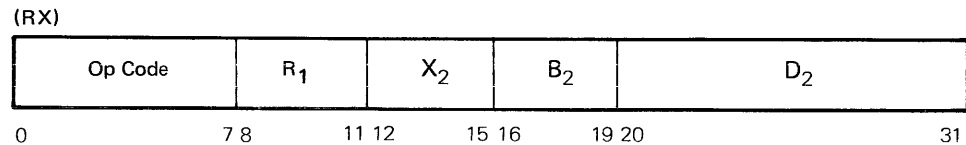
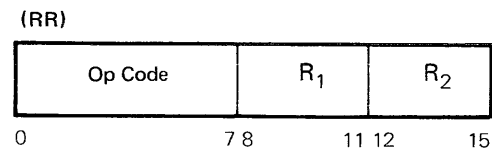

- Load Word
- Add Word
- Add Logical
- Subtract Word
- Subtract Logical
- Compare Word
- Multiply Word
- Divide

- Load and Test (RR only)
- Load Complement (RR only)
- Load Positive (RR only)
- Load Negative (RR only)
- Load Halfword (RX only)
- Add Halfword (RX only)
- Subtract Halfword (RX only)
- Compare Halfword (RX only)
- Multiply Halfword (RX only)
- Convert to Binary (RX only)
- Convert to Decimal (RX only)
- Store Word (RX only)
- Store Halfword (RX only)

Format RS:

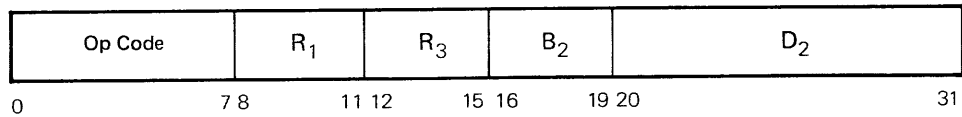

- Load Multiple
- Store Multiple
- Shift Left Single
- Shift Right Single
- Shift Left Double
- Shift Right Double

Decimal Arithmetic Instructions

These instructions perform arithmetic operations on binary-coded decimal data in packed (two decimal digits per byte) format. Decimal arithmetic instructions employ the SS format as shown:

Format SS:

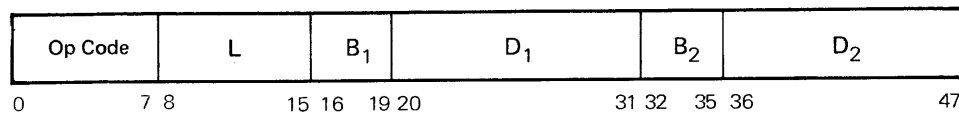

Add Decimal
 Subtract Decimal
 Zero and Add
 Compare Decimal
 Multiply Decimal
 Divide Decimal
 Pack
 Unpack
 Move With Offset

Floating-Point Arithmetic Instructions

These instructions provide the means to process large magnitude numbers with great precision required in scientific applications. The formats employed for floating-point arithmetic instructions are as follows. It should be noted that although the short and long instruction formats appear identical, the operation codes are unique and the instruction operands differ.

Formats RR Short, RR Long, RX Short and RX Long:

(RR Short and Long)

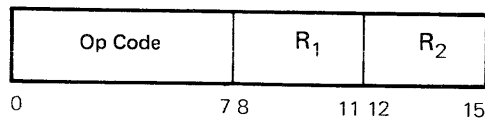

(RX Short and Long)

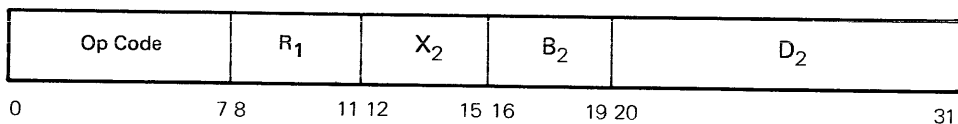

Load
 Add Normalized
 Add Unnormalized
 Subtract Normalized
 Subtract Unnormalized
 Compare

Multiply

Divide

Load and Test (RR short and long only)

Load Complement (RR short and long only)

Load Positive (RR short and long only)

Load Negative (RR short and long only)

Halve (RR short and long only)

Store (RX short and long only)

LOGICAL INSTRUCTIONS

These instructions provide the means for comparing, translating, editing, bit testing, and bit setting operations on fixed- or variable-length data. The formats employed for logical instructions are as follows:

Formats RR, RX, SI, and SS:

(RR)

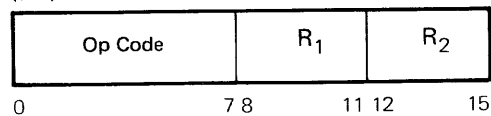

(RX)

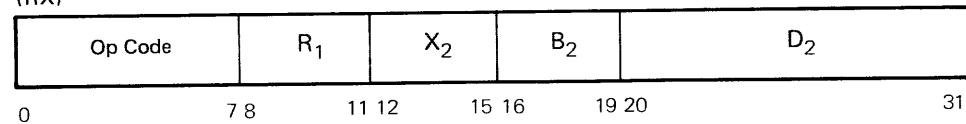

(SI)

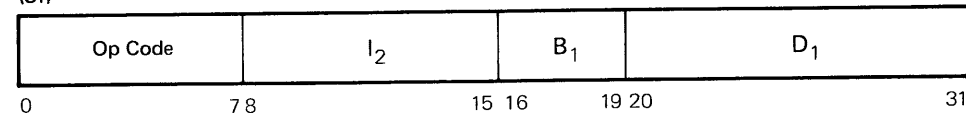

(SS)

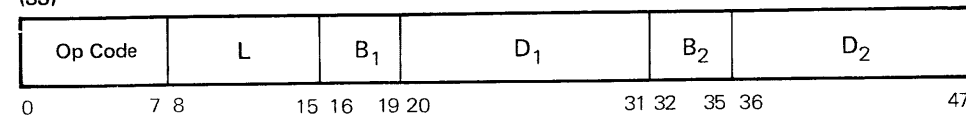

Compare Logical

AND

OR

Exclusive OR

Insert Character (RX only)

Store Character (RX only)

Move (SI and SS only)

Test and Set (SI only)

Test Under Mask (SI only)

Move Numerics (SS only)

Move Zones (SS only)

Translate (SS only)

Translate and Test (SS only)

Edit (SS only)

Edit and Mark (SS only)

Format RS:

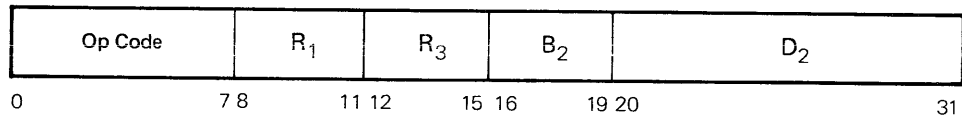

Shift Left Single Logical

Shift Right Single Logical

Shift Left Double Logical

Shift Right Double Logical

BRANCHING INSTRUCTIONS

These instructions provide the means for determining the next function of the program by the results of a tested condition. The formats employed for branching instructions are as follows:

Formats RR and RX:

(RR)

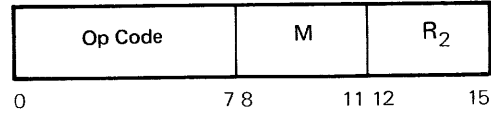

(RX)

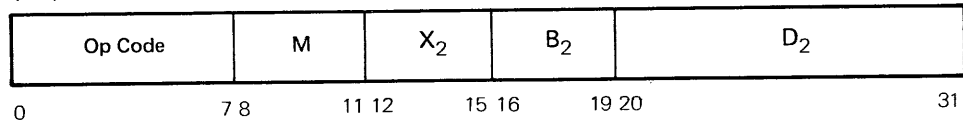

Branch on Condition

Branch and Link

Branch on Count

Execute (RX only)

Format RS:

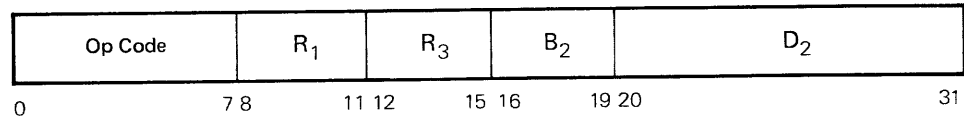

Branch on Index High

Branch on Index Low or Equal

PROCESSOR STATE CONTROL INSTRUCTIONS

There are only two processor state control instructions. One instruction provides the means for the program to change from processor states P_1 , P_2 , or P_4 , to processor state P_3 (interrupt control state). The other instruction permits setting the program mask and condition code for the current program state. The RR is employed for processor state control instructions as follows:

Format RR:

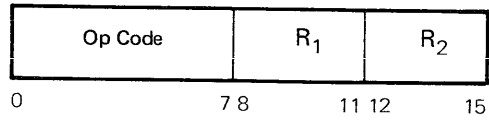

Supervisor Call

Set Program Mask

PRIVILEGED MODE INSTRUCTIONS

These instructions provide basic, usually operating-system controlled, processing functions. These instructions can only be executed when the processor is in what is designated as the privileged mode. Formats employed for privileged mode instructions are as follows:

Format RR:

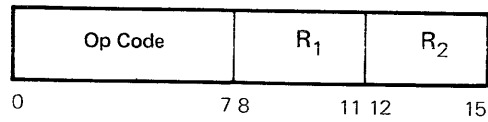

Set Storage Key

Insert Storage Key

Format SI:

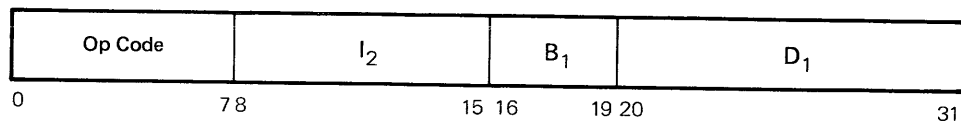

Function Call

Program Control

Write Direct

Read Direct

Idle

Diagnose

Start Device

Halt Device

Test Device

Check Channel

Format SS:

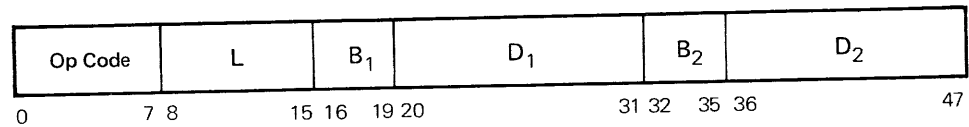

Load Scratchpad

Store Scratchpad

Load Shaded Memory

Store Shaded Memory

SPECIAL FUNCTIONS

The special functions are employed in the processors designed to operate in the time-sharing environment. Special functions are implemented with the privileged Function Call instruction. Formats employed for special functions are as follows:

Format:

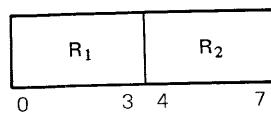

RCA 7:

Clear Content Addressable Memory

Analyze for Pre-Paging

Load Block Area

RCA 3:

Load Translation Memory

Scan Translation Memory and Store

Store Translation Memory

Format:

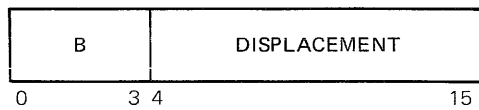

RCA 7:

Load Block Table Pointer

Store Block Table Pointer

Store Error Cause Register

Store Content Addressable Memory

Execute Relink

Clear Main Memory

Analyze Paging Interrupt

Load Interval Timer

Store Interval Timer

RCA 3:

Load Interval Timer

Store Interval Timer

Paging Queue and Paging Error Interrupt Service

Section 3: SPECIAL PROCESSOR FEATURES

GENERAL

Special features provide for a wide range of applications within a given system. They also provide for expansion of existing systems. This "tailoring" allows the RCA Series system user to choose those features which help to achieve the greatest possible system utilization in a given application. Special features applicable to each equipment model are listed under model headings. The following is a brief description of some of the more prominent special features offered.

DIRECT CONTROL

Systems where more than one processor are connected to share peripheral devices, memory, or work load require extra machine-program communications interface. The direct-control special feature provides this interface for rapid signaling between up to six processors, independently of input/output operation, in such a system. Two instructions, Write Direct and Read Direct, are used to implement this special feature. The feature operates to cause an interrupt which is serviced by the signaled processor. RCA Series processors with this feature may be operated together in any model combination. The direct-control cable special feature is used to interconnect the processors in a direct control system.

EMULATORS

The emulator special features provide for the running of RCA 301 or 501, or IBM 1401 or 1410, object-coded programs on the applicable processor. The programs are run without modification or reprogramming, however, certain conditions must be considered before emulation is attempted. Processors with an emulator special feature are provided with additional read-only memory and employ special software.

SELECTOR CHANNELS

The selector channels, once started, operate concurrently with the processor to control the transfer of data to and from the peripheral devices. Each selector channel has a trunk or trunks to which the device controller or the peripheral device is connected. The selector channel in addition to operating concurrently with the processor can operate concurrently with other channels. The number of selector channels, number of trunks, and the transfer rate vary with the processor models.

RUN TIME RECORDER INTERFACE

This feature provides a means of connecting non-RCA time recorders to RCA Series processors which use the RCA 8097-020 Operator Console.

The connector output provides a voltage level which changes when the processor is in the active state.

This feature operates with instruments made by Datachron Corp. Specifications of the interface will be made available upon request to any manufacturer of time recording devices and it is the responsibility of the manufacturers to conform to the requirements of this feature.

MEMORY EXPANSION

These features provide for expansion of memory in certain models of the RCA 6 and 7 Processors from 262KB to over 2000KB. This can be done in modular steps, depending on user requirements.

Section 4 – RCA SERIES PROCESSOR SUMMARY

GENERAL

The central processor unit, memory modules, and input/output channels comprise the heart of the RCA Series systems. This section presents a summary of all system characteristics for the RCA 2, 3, 6 and 7 Processors.

MODEL RCA 2

The Model RCA 2 Processor (figure 1-5) is a general-purpose, stored-program, digital processor designed for medium-scale processing applications. The extensive instruction complement, rapid transmission and computation rates of the RCA 2 provide for efficient information processing and scientific applications. The program instructions are executed under the control of a read-only memory. A high-speed scratchpad memory contains a set of control and general-purpose registers for each of the four states of operation, thus providing fast interrupt service. Nonaddressable main memory provides control data storage for the devices on the multiplexor channel.

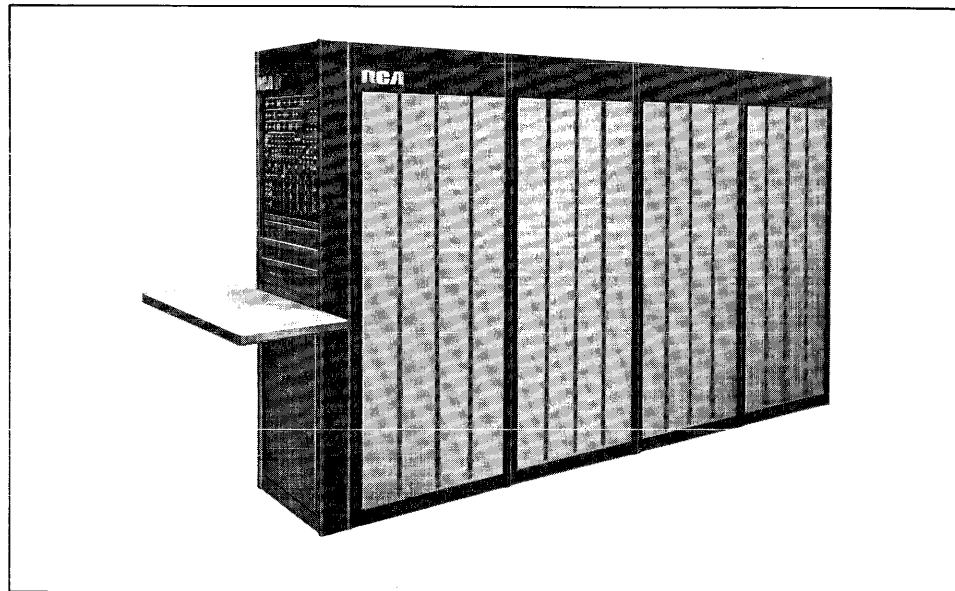

FIGURE 1-5. MODEL RCA 2 PROCESSOR
SPECTRA 70/45

The RCA 2 Processor and associated memory modules are available in specific combinations as follows:

| Processor Model Number | To Incorporate Memory Size(s) of: | Memory Model Number(s) |
|------------------------|-----------------------------------|------------------------|
| 8002-001 | 65,535 bytes | 8000-011 |
| 8002-002 | 131,072 bytes or | 8000-013 |
| -- | 262,144 bytes | 8000-015 |

Figure 1-6 is a summary of Model RCA 2 Processor data.

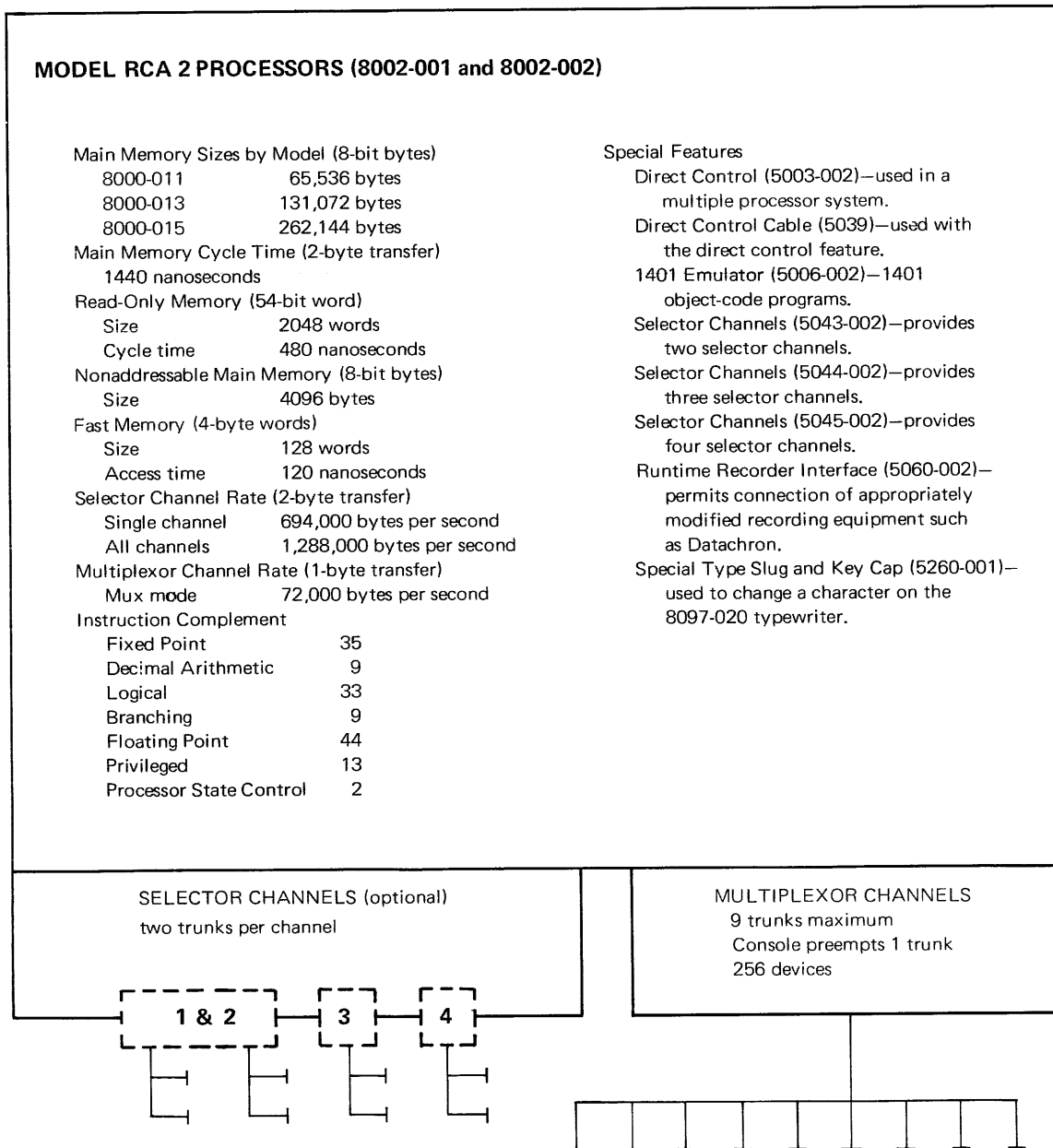

FIGURE 1-6. RCA 2 PROCESSOR DATA

MODEL RCA 3

The Model RCA 3 Processor (figure 1-7) operates under control of the Virtual Memory Operating System (VMOS). The RCA 3 incorporates a read-only memory, scratchpad memory, a translation memory, and an interval timer. The translation memory is used by the operating system to implement a virtual memory (over 2,000,000 bytes) which greatly exceeds the capacity of the real main memory of the processor. The interval timer provides a time-slicing function used by the operating system to interleave active programs. The Model RCA 3 can operate in either the virtual address mode or the direct-address (RCA 2) mode. In the virtual address mode the translation memory is implemented; in the direct-address mode (RCA 2) only direct addressing occurs. The RCA 3 offers four selector channels with two trunks each which, together with the multiplexor channel, provides 17 input/output trunks.

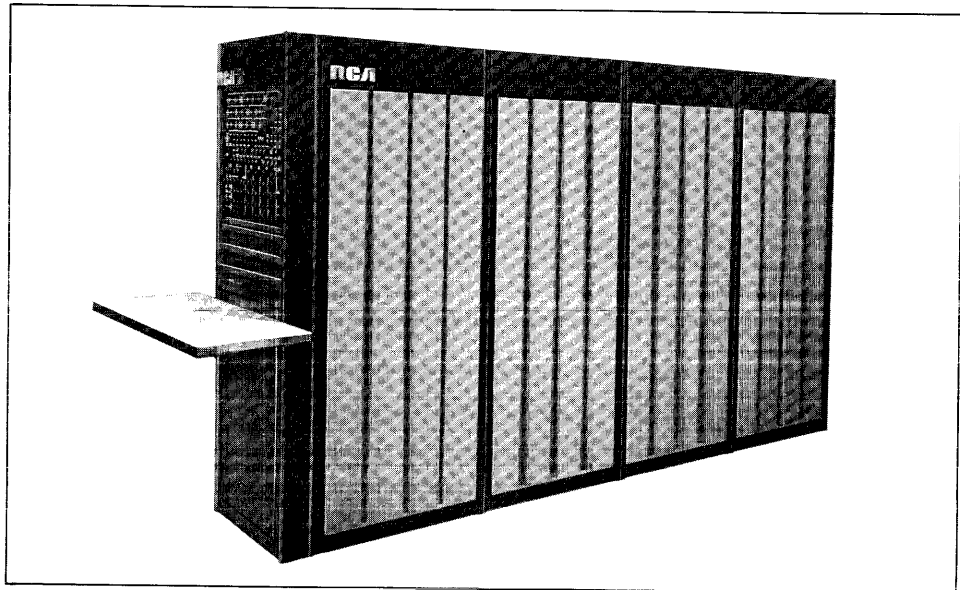

FIGURE 1-7. MODEL RCA 3 PROCESSOR
SPECTRA 70/46

The RCA 3 Processor and associated memory modules are available in specific combinations as follows:

| Processor Model Number | To Incorporate Memory Size of: | Memory Model Number |
|------------------------|--------------------------------|---------------------|
| 8003-001 | 131,072 bytes | 8000-013 |
| 8003-002 | 262,144 bytes | 8000-015 |

Figure 1-8 is a summary of Model RCA 3 Processor data.

MODEL RCA 3 PROCESSORS (8003-001 and 8003-002)

Main Memory Sizes by Model (8-bit bytes)

| | |
|----------|---------------|
| 8000-013 | 131,072 bytes |
| 8000-015 | 262,144 bytes |

Main Memory Cycle Time (2-byte transfer)
1.44 microseconds

Read-Only Memory (54-bit words)

| | |
|------------|-----------------------------|
| Size | Up to three 2048-byte banks |
| Cycle time | 480 nanoseconds |

Nonaddressable Main Memory (8-bit bytes)

| | |
|------|------------|
| Size | 4096 bytes |
|------|------------|

Scratchpad Memory (4-byte words)

| | |
|-------------|-----------------|
| Size | 128 words |
| Access time | 120 nanoseconds |

Transaction Memory (16-bit halfwords)

| | |
|-------|-----------------|
| Size | 512 halfwords |
| Cycle | 300 nanoseconds |

Interval Timer (16-bit halfword)

| | |
|-----------|--------------------------|
| Range | 0.0001 to 6.6635 seconds |
| Decrement | 100 microseconds |

Selector Channel Rate (2-byte transfer)

| | |
|----------------|----------------------------|
| Single channel | 694,000 bytes per second |
| All channels | 1,388,000 bytes per second |

Multiplexor Channel Rate

| | |
|----------|-------------------------|
| Mux Mode | 72,000 bytes per second |
|----------|-------------------------|

Instruction Complement

| | |
|-------------------------|-----|
| Fixed Point | 35 |
| Decimal Arithmetic | 9 |
| Logical | 33 |
| Branching | 9 |
| Floating Point | 44 |
| Privileged | 14* |
| Processor State Control | 2 |

*plus six special functions

Special Features

Direct Control (5003-003)—used in a multiprocessor system.

Direct Control Cable (5039)—used with the direct control feature.

1401 Emulator (5006-003)—1401 object code program.

Selector Channels (5040-003)—provides two selector channels.

Selector Channels (5041-003)—provides three selector channels.

Selector Channels (5042-003)—provides four selector channels.

Runtime Recorder Interface (5060-003)—permits connection of appropriately modified recording equipment such as Datachron.

Special Type Slug and Key Cap (5260-001)—used to change a character on the 8097-020 typewriter.

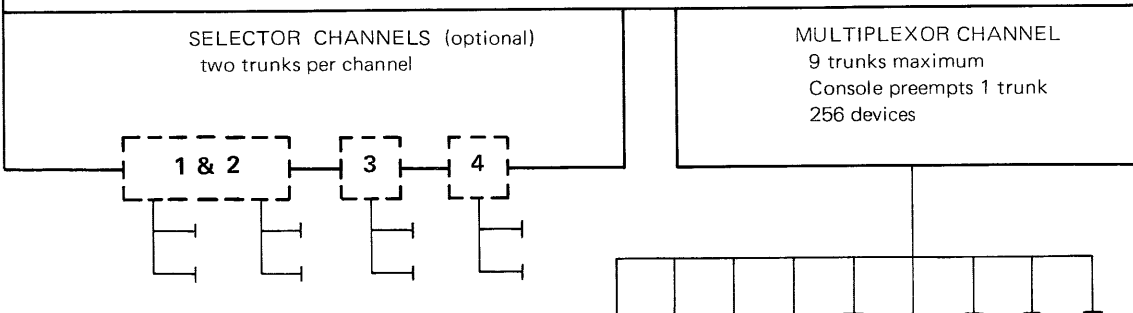

FIGURE 1-8. RCA 3 PROCESSOR DATA

MODEL RCA 6

The Model RCA 6 Processor (figure 1-9) incorporates design features to fulfill the requirement of a medium-to-large scale processing system. The RCA 6 offers improved computation and data transmission speeds with greater input/output capability. The speeds of main memory, scratchpad memory, and read-only memory have been greatly increased along with error detection and recovery capability. Main memory can be expanded to over 2,000,000 bytes. Two selector channels are standard with the provision for expansion to six channels with three trunks on each channel. The multiplexor channel has provision for a maximum of 16 trunks for a total of 34 input/output trunks.

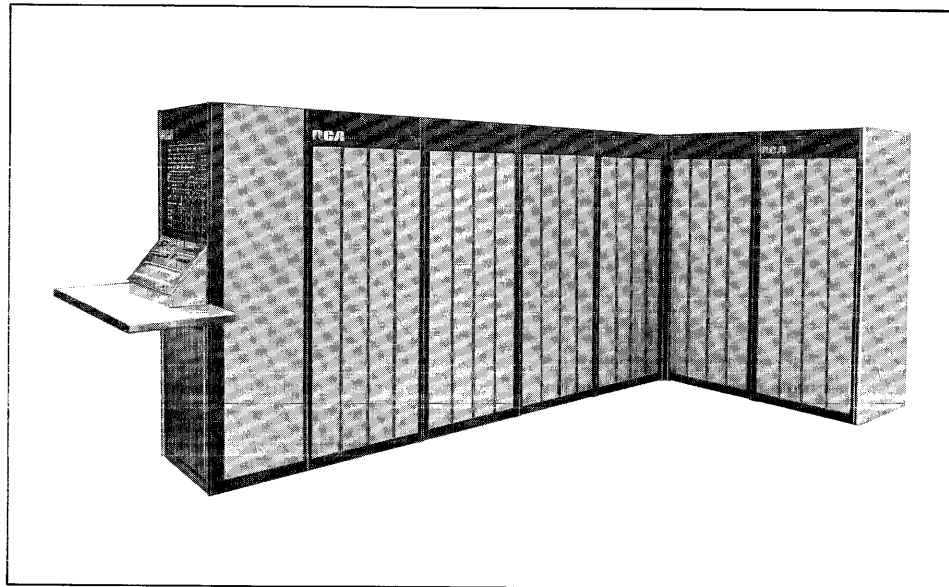

FIGURE 1-9. MODEL RCA 6 PROCESSOR

The RCA 6 Processor and associated memory modules are available in specific combinations as follows:

| Processor Model Number | To Incorporate Memory Size(s) Of: | Memory Model Number |
|------------------------|--------------------------------------|---------------------|
| 8006-001 | 131,072 bytes | 8000-013 |
| 8006-002 | 262,144 bytes | 8000-015 |
| — — | and higher* | — — |

*See page 1-30 — Main Memory Sizes.

Figure 1-10 is a summary of the Model RCA 6 Processor data.

MODEL RCA 6 PROCESSORS (8006-001 and 8006-002)

*Main Memory Sizes by Model (8-bit bytes)

| | |
|----------|-----------------|
| 8000-013 | 131,072 bytes |
| 8000-015 | 262,144 bytes |
| 8000-017 | 393,216 bytes |
| 8000-019 | 524,288 bytes |
| 8000-020 | 655,360 bytes |
| 8000-021 | 786,432 bytes |
| 8000-022 | 917,504 bytes |
| 8000-023 | 1,048,576 bytes |
| 8000-025 | 1,310,720 bytes |
| 8000-027 | 1,572,864 bytes |
| 8000-029 | 1,835,008 bytes |
| 8000-031 | 2,097,152 bytes |

Main Memory Cycle Time (4-byte transfer)

765 nanoseconds

Shaded Main Memory (128-bit Quadruple words)

Size one 256 quadruple-word module per 131 kilobytes of main memory.

Read-Only Memory (72-bit words)

Size 3072 words
Cycle time 255 nanoseconds

Fast Memory (32-bit words)

Size 128 words
Access time 85 nanoseconds

Selector Channel Rate (4-byte transfer)

Single channel 900,000 bytes per second
All channels 5,240,000 bytes per second

Multiplexor Channel Rate

Mux mode 216,000 bytes per second

Instruction Complement

| | |
|-------------------------|----|
| Fixed Point | 35 |
| Decimal Arithmetic | 9 |
| Logical | 33 |
| Branching | 9 |
| Floating Point | 44 |
| Privileged | 15 |
| Processor State Control | 2 |

Special Features

Direct Control (5003-006)—used in a multiple-processor system.

Direct Control Cable (5039)—used with the direct control feature.

301 Emulator (5064-006)—provides for emulating the RCA 301 system.

501 Emulator (5065-006)—provides for emulating the RCA 501 system.

1401 Emulator (5081-006)—provides for emulating the IBM 1401 system.

1410/7010 Emulator (5026-006)—provides for emulating the IBM 1410/7010 systems.

Selector Channels (5057-306)—provides for three selector channels.

Selector Channels (5057-406)—provides for four selector channels.

Selector Channels (5058-506)—provides for five selector channels.

Selector Channels (5058-606)—provides for six selector channels.

Runtime Recorder Interface (5060-006)—permits connection of appropriately modified recording equipment such as Datachron.

Special Type Slug and Key Cap (5260-001)—used to change a character on the 8097-020 typewriter

Memory Expansion, 8006-002 Processor (5073)—provides for expansion of memory from 262KB to 393KB.

Memory Expansion, 8006-002 Processor (5074)—provides for expansion of memory from 262KB to 524KB.

Memory Expansion, 8006-002 Processor (5075)—provides for expansion of memory from 262KB to 655KB.

Memory Expansion, 8006-002 Processor (5076)—provides for expansion of memory from 262KB to 786KB and higher.

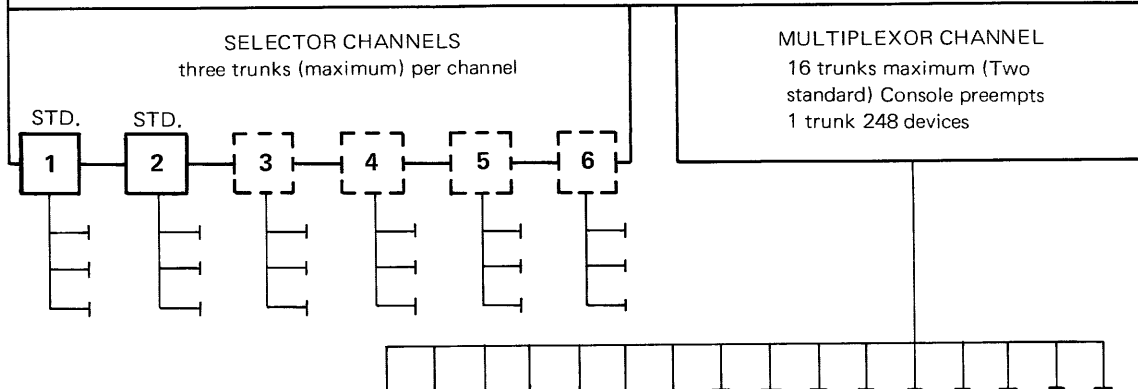

FIGURE 1-10. RCA 6 PROCESSOR DATA

MODEL RCA 7

The Model RCA 7 Processor (figure 1-11) is an enhanced medium-to-large scale processor extending the interactive and batch processing capabilities of the Model RCA 3. The RCA 7 is consistent with the RCA Series of medium-to-large scale processors with additional features which facilitate applications in a time-shared, multiple access environment. The RCA 7 offers main memory sizes from 262,144 bytes to 2,097,152 bytes, a 765-nanosecond (4-byte transfer) main memory, extensive error detection and recovery capability, and greater input/output speeds and capacity. Along with the read-only memory and scratchpad memory, the RCA 7 incorporates a content-addressable memory and an interval timer. The content-addressable memory is used in conjunction with a three-level table lookup scheme to implement a virtual memory (over 8,000,000 bytes) which greatly exceeds the capacity of the real main memory of the processor. The interval timer provides a time-slice function used by the operating system to interleave active programs. The Model RCA 7 can operate in either the virtual address mode or the direct address (RCA 6) mode. In the virtual address mode the address translation is implemented; in the direct address (RCA 6) mode only direct addressing occurs. Two selector channels are standard with provisions for expansion to six channels with three trunks on each. The multiplexor channel has provisions for a maximum of 16 trunks for a total of 34 input/output trunks.

Figure 1-12 is a summary of the Model RCA 7 Processor data.

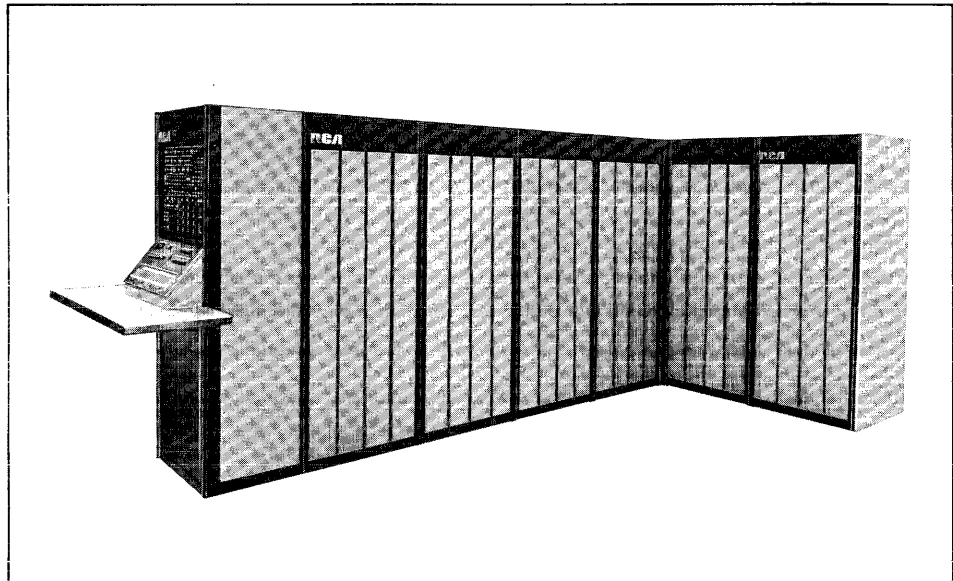

FIGURE 1-11. MODEL RCA 7 PROCESSOR

MODEL RCA 7 PROCESSOR (8007-001)

Main Memory Sizes by Model (8-bit bytes)

| | |
|----------|-----------------|
| 8000-013 | 131,072 bytes* |
| 8000-015 | 262,144 bytes |
| 8000-017 | 393,216 bytes |
| 8000-019 | 524,288 bytes |
| 8000-020 | 655,360 bytes |
| 8000-021 | 786,432 bytes |
| 8000-022 | 917,504 bytes |
| 8000-023 | 1,048,576 bytes |
| 8000-025 | 1,310,720 bytes |
| 8000-027 | 1,572,864 bytes |
| 8000-029 | 1,835,008 bytes |
| 8000-031 | 2,097,152 bytes |

Main Memory Cycle Time (4-byte transfer)

765 nanoseconds

Shaded Main Memory (128-bit quadruple words)

Size One 256 quadruple-word module per 131 kilobytes of main memory

Read-Only Memory (72-bit words)

Size 3072 words
Cycle time 255 nanoseconds

Fast Memory (32-bit words)

Size 128 words
Access time 85 nanoseconds

Content Addressable Memory

Size eight, 64-bit elements (one alpha word and one beta word)

Interval Timer (16-bit halfword)

Range 0.0001 to 6.6635 seconds
Decrements 100 microseconds

Selector Channel Rate (4-byte transfer)

Single Channel 900,000 bytes per second
All Channels 5,240,000 bytes per second

Multiplexor Channel Rate

Mux mode 216,000 bytes per second

Instruction Complement

| | |
|-------------------------|------|
| Fixed Point | 35 |
| Decimal Arithmetic | 9 |
| Logical | 33 |
| Branching | 9 |
| Floating Point | 44 |
| Privileged | 16** |
| Processor State Control | 2 |

Special Features

- Direct Control (5003-007) – used in a multiprocessor system
- Direct Control Cable (5039)–used with the direct control feature
- 301 Emulator (5064-007)–provides for emulating the RCA 301 system.
- 501 Emulator (5065-007)–provides for emulating the RCA 501 system.
- 1401 Emulator (5081-007)–provides for emulating the IBM 1401 system.
- 1410/7010 Emulator (5026-007)–provides for emulating the IBM 1410/7010 systems.
- Selector Channels (5057-307)–provides for three selector channels.
- Selector Channels (5057-407)–provides four selector channels.
- Selector Channels (5058-507)–provides for five selector channels.
- Selector Channels (5058-607)–provides six selector channels.
- Run Time Recorder Interface (5060-007)–permits connection of appropriately modified recording equipment such as Datachron.
- Special Type Slug and Key Cap (5260-001)–used to change a character on the 8097-020 typewriter.
- Memory Expansion (5077)–provides for expansion of memory from 262KB to 393KB.
- Memory Expansion (5078)–provides for expansion of memory from 262KB to 524KB.
- Memory Expansion (5079)–provides for expansion of memory from 262KB to 655KB.
- Memory Expansion (5080)–provides for expansion of memory from 262KB to 786KB and higher.

*To be used for module expansion only. Minimum memory size for RCA 7 is 262,144 bytes.

**Plus six special functions.

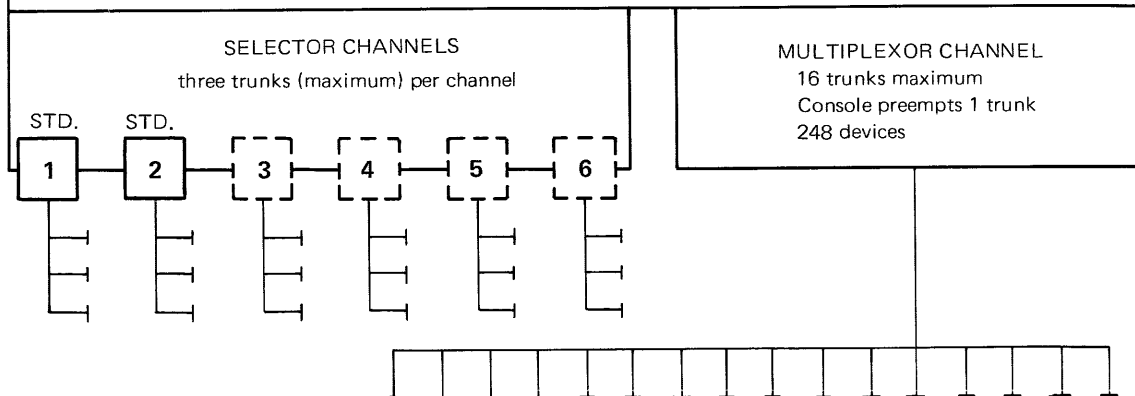

FIGURE 1-12. RCA 7 PROCESSOR DATA

Section 5: PUBLICATIONS PLAN FOR RCA SERIES PROCESSORS

Publications for the RCA Series processors are depicted in figure 1-13. The applicable publication ordering numbers will be supplied as these publications are made available. Each type of publication represented is described briefly in this section.

The publications are grouped according to the audience to which they are directed:

1. General reader: all users but specifically corporate and information processing management.
2. Technical reader: operators, programmers, systems personnel, trainees.

The basic publication for corporate and information processing management is the RCA Series Systems Information Manual. This manual outlines the RCA Series family of related equipment and operating systems with emphasis on user benefits. This initial overview stresses special features, operational advantages, and individual components and component structure. The level of detail is intended for planning purposes, not for actual programming or operation of the equipment.

Publications for computer operators, programmers, systems personnel, trainees are the RCA Series Processor Reference and Operating Manuals.

The RCA Series Processor Reference Manuals – These manuals provide a general description of the subject processor covering system design, configuration requirements and restrictions capabilities, performance specifications, and optional features. This is followed by operational or functional descriptions including data formats, error conditions and controls, operational cycles and modes, mechanical operations, etc. Peripheral operations are described with the central processor instruction that initiates each operation showing bit structure of the operands. In addition, multiprocessor operation and interfaces are discussed.

The RCA Series Processor Operating Manuals – These manuals consist of basic equipment configuration, and a general description of the system covering the processor capabilities and features specifying all operating codes.

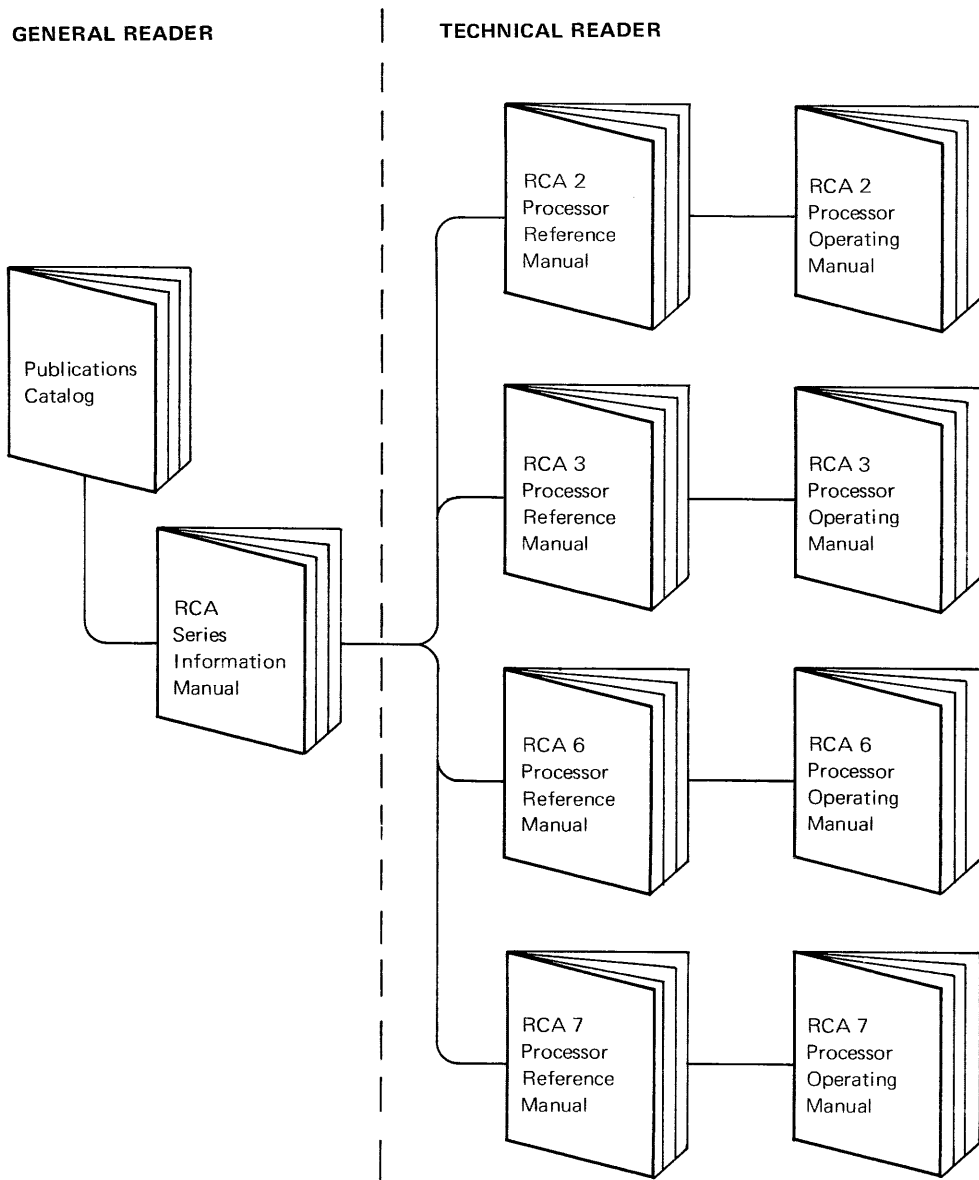

FIGURE 1-13. RCA SERIES PROCESSORS PUBLICATIONS PLAN

The RCA Series Peripherals

INTRODUCTION

The RCA Series peripherals are a highly flexible family of device controllers and peripheral devices, designed to meet today's technological requirements. Depending on whether the system is designed for simultaneous interactive processing or batch processing, a peripheral pool of RCA Series peripheral devices are waiting to be called upon. These devices include:

Random access systems consisting of drum memory, disc storage, and other mass storage devices, all operating with either the same or a dedicated controller.

A new 333KB/sec. drum auxiliary storage that provides 512 or 1600 page-sized tracks for fast page swapping.

Direct access storage systems that can be supplied with up to 16 on-line disc storage units. A spare unit is provided (for each group of eight units) that can quickly replace any on-line unit that requires servicing or routine maintenance.

A family of punched card devices with reading speeds up to 1435 cards per minute and an optional mark-reading feature.

On-line high-speed printers, with rates up to 1250 lines per minute with either drum or train type of printing, to satisfy the most demanding horizontal quality that is necessary for optical character reading requirements.

Remote terminals such as teleprinters and RCA Video Data Terminals such as the 8752-100 with a 1080-character display makes it ideal for interactive text editing and document maintenance.

Slower peripheral devices and communications lines, serviced by the communications controller-multichannel and the front end communication processor, are operated by the RCA Series multiplexor channels. New high-speed selector channels simultaneously operate fast devices.

GENERAL

The following console devices, which provide for operator communication with the RCA Series processors from strategically located remote locations, allow totally integrated operation, supervisory monitoring, and maintenance accessibility to the RCA Series computer systems. Display capability, documentation, and input functions are greatly enhanced through decentralization of operations personnel to areas of the computing environment requiring operational coordination.

MODEL 8091 VIDEO OPERATOR CONSOLE AND 8092 AUXILIARY CONSOLE

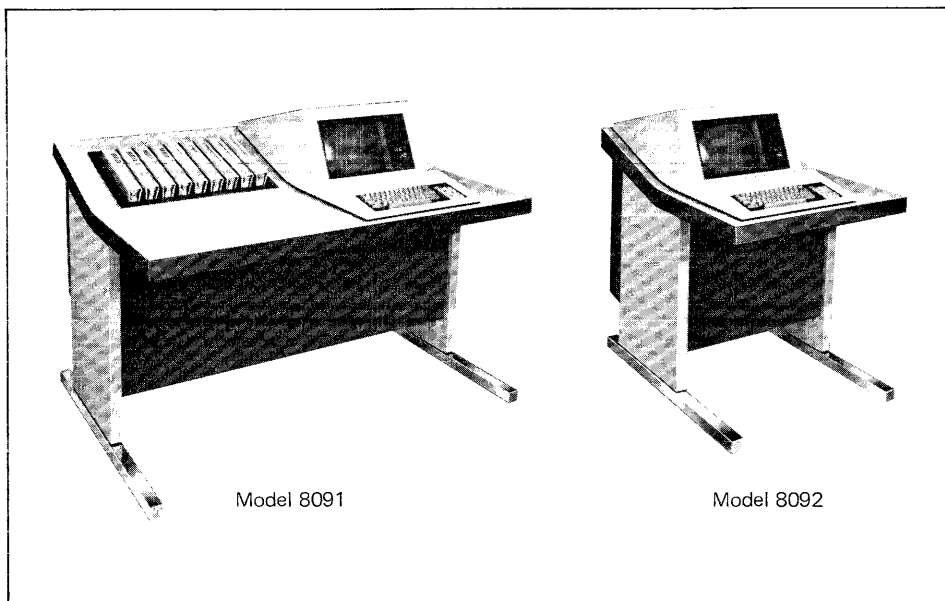

The RCA 8091 Video Operator Console which provides operator communications with the processor, consists of a video display with keyboard and provisions to operate the free-standing Model 8093 Printer and Model 8094 Card Reader. The console is interfaced to the multiplexor channel by way of the control electronics housed within the video console cabinet.

Housed in the RCA 8091 Video Operator's Console are the video display, power supply, keyboard, and control electronics with maintenance panel.

In addition to the RCA 8091 Video Operator's Console, the control electronics contained in the RCA 8091 can accommodate up to seven 8092 Auxiliary Consoles. The RCA 8092 Auxiliary Console consists of a video display, power supply and keyboard. When used on-site, the auxiliary console(s) can be cable-connected up to 1000 feet from the RCA 8091 Video Operator's Console. When used remotely, the auxiliary console(s) can easily be interfaced to the RCA 8091 by way of the data sets.

Provision is made for any console to be used for the following functions:

1. Backup Operator.
2. Supervisory Monitor.
3. Maintenance Device.
4. Remote (off-site) console by way of standard modem.

The console contains sufficient memory and control for two independent displayable pages, either of which may be selected for viewing. One page is the normal input page which is 13 lines, each containing 80 characters. The other is the status page and consists of 12 lines, each containing 80 characters.

The keyboard portion of the console contains provisions for encoding 96 characters, and sufficient additional controls and indicators to facilitate console operations. For example, the controls include: COIN, STOP, START, GEN. RESET, and LOAD.

The RCA 8091 Video Operators Console occupies one multiplexor trunk. The console's control electronics accommodates a total of up to 16 software addressable devices. These devices are the RCA 8091 Video Operators Console, seven RCA 8092 Auxiliary Consoles, and up to eight RCA 8094 Card Readers. Therefore, the number of card readers cannot exceed the number of consoles and the total number of consoles and card readers cannot exceed 16.

Special Features

Feature 5069 – Light Pen – permits the operator to select one of several messages presented by the processor. These messages can be displayed on either of the two pages. Messages may consist of alternative actions recommended by the processor, for resolution of a job or problem, or an operator task response.

Feature 5072 – Variable Function Keyboard – provides an auxiliary pad of eight function keys on the Model 8091 or 8092 Console with up to 16 different overlay masks which allow automatic code generation for up to 96 separate functions. With this feature, the operator can call up to 96 separate routines with a single keystroke.

MODEL 8093 CONSOLE PRINTER

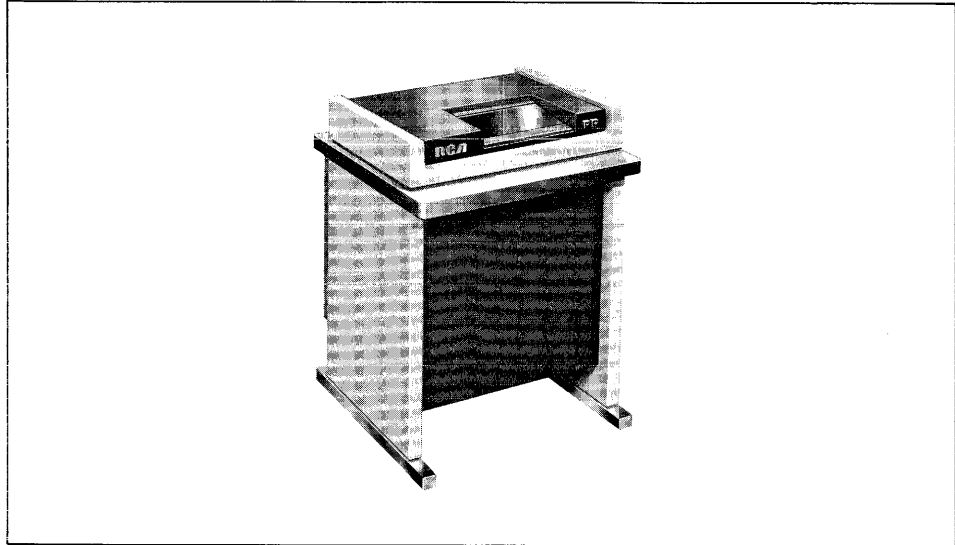

The RCA 8093 Console Printer available with the video console, is a free-standing teleprinter, cable-connected to the RCA 8091 Console by way of an adapter included with the printer. At least one 8093 Printer is required for the RCA 8091 Video Operator's Console when operating under existing operating systems. The 8093 Printer is optional on new RCA Series Systems operating under VMOS and OS/70. A maximum of eight RCA 8093 Printers can be accommodated, one for each console either Model 8091 or 8092. The printer operates from a buffer in the console, and prints at a rate of 15 characters/second.

MODEL 8094 CONSOLE CARD READER

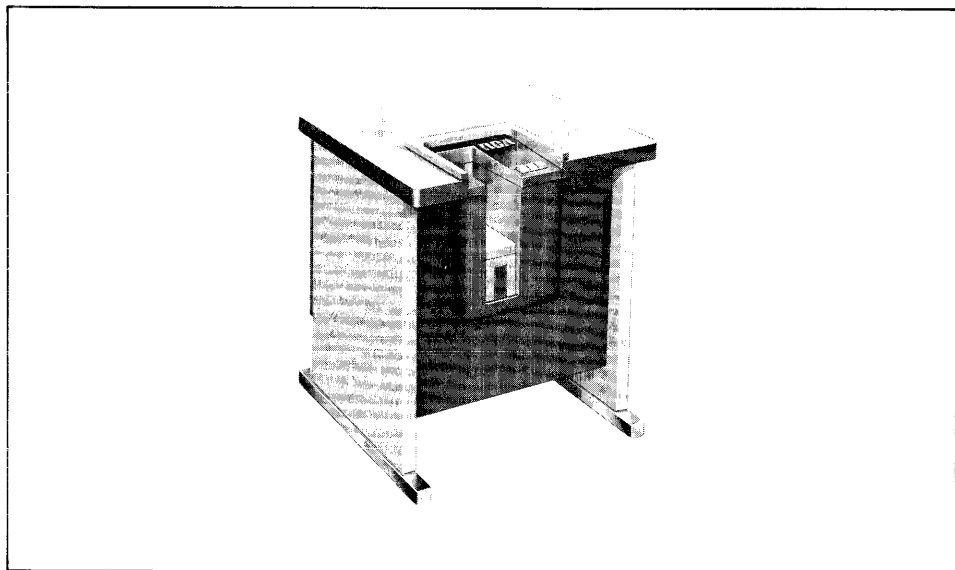

The RCA 8094 Console Card Reader is available with the 8091 Video Operators Console for inserting data or parameter card entries to the

processor. Cards are read at a rate of 50 cards/minute. The card reader is program-compatible with standard systems card readers.

One RCA 8094 Card Reader can be connected to each console Model 8091 or 8092 by way of an adapter included with the card reader. A maximum of eight RCA 8094 Card Readers and seven RCA 8092 Auxiliary Consoles can be accommodated by one Model 8091 Video Operators Console but the number of 8094's cannot exceed the total combined number of 8091's and 8092's.

MODEL 8097-020 CONSOLE

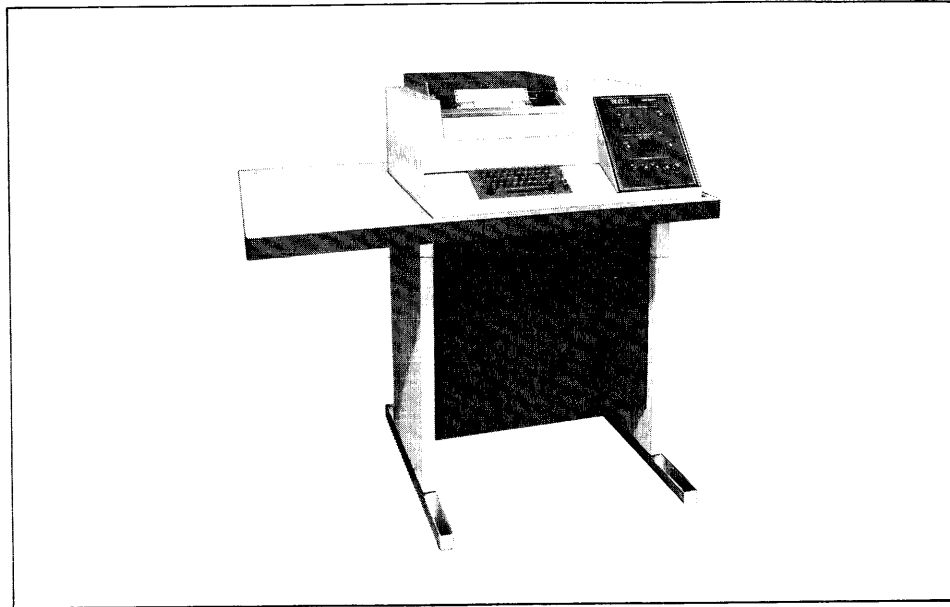

The Model 8097-020 is a free-standing, self-contained unit which provides control to enable system operation in conjunction with the operating system programs. The operator communicates with the system by way of a set of control switches and a console typewriter.

The set of control switches on the console allows for loading memory, starting programs, displaying current processing state, and interrupting processor operation.

The typewriter, mounted on the console, enables the operator to communicate with the operating system programs and vice versa. The keyboard of the typewriter can be interlocked to prevent unintentional entry of data. An indicator lamp indicates the status of the interlock (on/off).

Control electronics permits communication with the processor by way of the RCA standard interface. The control electronics for the console typewriter generates a parity bit for each character, and performs a bit-by-bit echo check on the characters sent to the typewriter. The RCA 8097-020 Console is always attached to the highest priority trunk on the multiplexor channel.

Special Features

Feature 5060 – Run Time Recorder Interface – permits the connection of other vendor's recording equipment (for example, Datachron) to an RCA processor using the 8097-020 Console. The independently-powered recorder senses whenever the processor is in run mode and this can measure processor active state time.

Feature 5260 – Special Type Slug and Key Cap – provides a substitute type slug and key cap bearing a special character instead of the standard graphic shown on the slug and cap for each character to be replaced.

GENERAL

A wide variety of paper tape handling devices capable of reading and punching information from or into paper tape is provided within the RCA Series peripheral family. Several speeds are available for reading or punching to provide a perfect match for any particular RCA Series installation. This section presents a concise overview of these configurable devices for the RCA Series processors.

MODEL 8221 PAPER TAPE READER/PUNCH

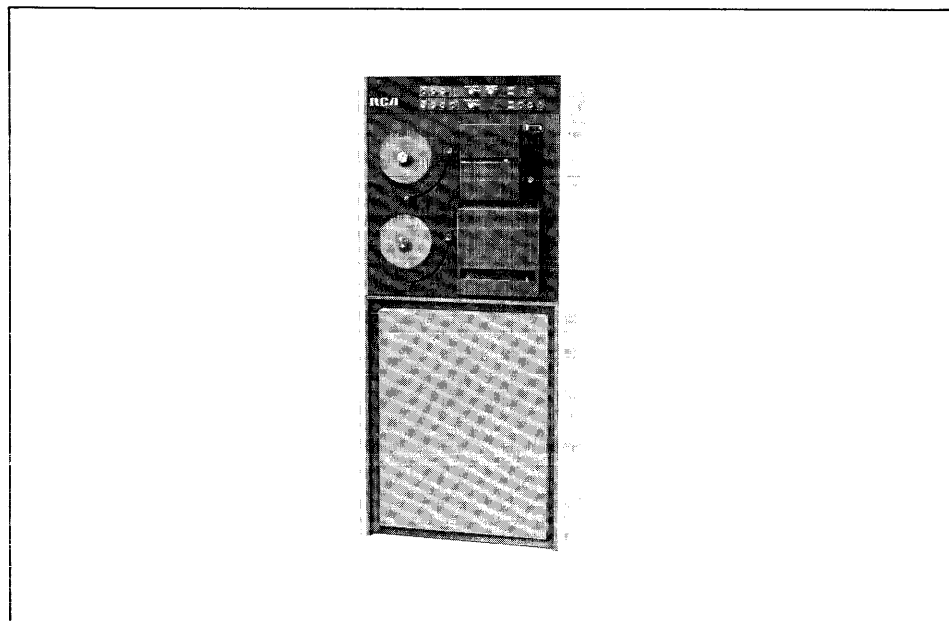

The RCA 8221 Paper Tape Reader/Punch consists of a 200 character-per-second reader and a 100 character-per-second punch. Manual controls are provided for selecting the width of the paper tape to be processed. Both the reader and the punch are capable of handling five-, six-, seven-, or eight-level paper tape. Either gap or gapless tape may be processed.

Parity checking is performed by the reader and the punch to control the accuracy of data. The paper tape reader has a switch which can be set to select odd, even, or no-parity checking. A character on paper tape that has bad parity is replaced in memory with the systems error byte hex FF.

The reader/punch handles 11/16-inch or 1-inch paper tape and provides spooling capability for reels up to 1000 feet in length. Paper tape strips may also be read by this device. The following options to the basic paper tape reader/punch are available:

EBCDIC Mode – This option provides the ability to punch and read a modified EBCDIC code with eight-level tape. The EBCDIC code from the processor is modified on punching so that even parity is placed on the paper tape. Ability to translate the paper tape code is contained in the reader. This option is factory installed only at time of order.

Advanced Sprocket Option (Punch) – This option converts punching to six-level, no parity, advanced sprocket tapes only instead of conventional tapes. This option is installed at the factory at time of order only.

The following model numbers apply to the 8221 Paper Tape Reader/Punch:

| | |
|----------|--|
| 8221-010 | Paper tape reader/punch. |
| 8221-011 | Paper tape reader/punch with EBCDIC option in reader and punch. |
| 8221-020 | Paper tape reader/punch with advanced sprocket punch. |
| 8221-021 | Paper tape reader/punch with advanced sprocket punch and EBCDIC option in reader only. |

Special Features

Feature 5219 – Advanced Sprocket Six-Level Read – provides the ability to read and/or punch six-level advanced sprocket hole tape.

Feature 5256 – Long Block Indicator – provides an indicator in the sense byte to permit the reading of blocks shorter than the block between gaps. The tape is then automatically advanced to the next gap under electronic control. This feature is required for 301 emulation.

Feature 5292 – 4N Terminate – permits termination upon recognition of four consecutive N characters (NNNN).

Feature 5296 – Read Kleinschmidt Format – permits reading of punched paper tape which has been punched in accordance with Kleinschmidt conventions relating to media and codes.

Feature 5297 – End of Tape – provides a program sensible indication upon sensing end-of-tape. It is used in applications requiring strip reading.

Feature 5298 – Gapless Mode – provides the capability of processing punched paper tape which contains character locations that are unpunched (gap characters). The feature allows continuous reading of this media by ignoring the unpunched areas.

Feature 5299 – Punched Kleinschmidt Format – permits punching of unpunched paper tape which is to be prepared in accordance with Kleinschmidt conventions relating to media and codes.

MODEL 8224 PAPER TAPE READER

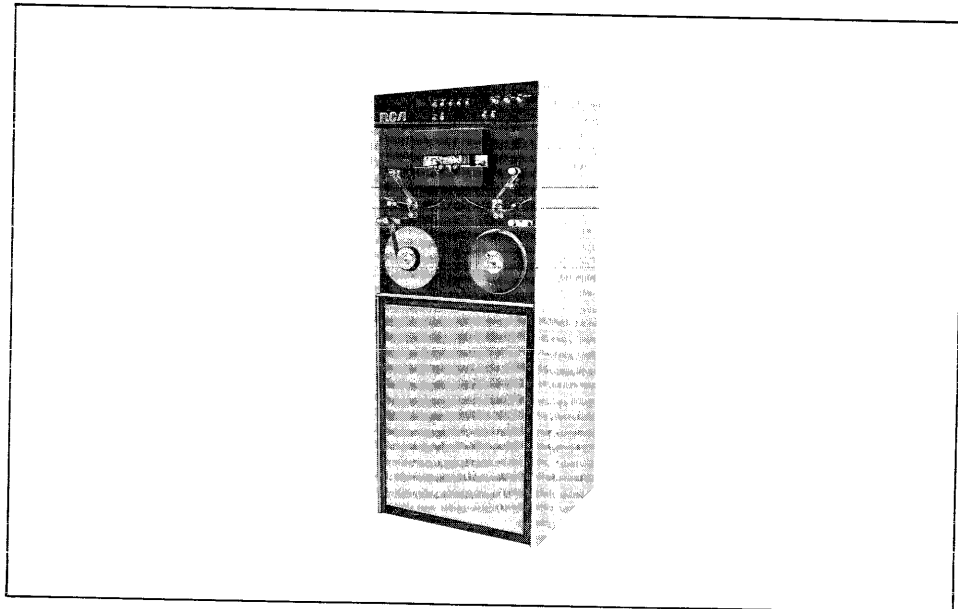

The RCA 8224 Paper Tape Reader operates at a speed of up to 1000 characters per second and reads data in five-, six-, seven-, eight-level code on commercially available media. Gapped or gapless tape with in-line or advanced sprocket holes may be processed.

The reader handles 11/16-inch, 7/8-inch or 1-inch paper tape, and spool capacity is 1000 feet. The following option to the basic paper tape reader is available:

EBCDIC Mode -- This option provides the ability to read a modified EBCDIC code with eight-level tape. When this option is included, the channel selector switch carries the legend EBCDIC after the eight-channel select position on the reader. This option is factory-installed only at time of order.

The following model numbers apply to the 8224 Paper Tape Reader:

- 8224-010 Paper tape reader.
- 8224-011 Paper reader with EBCDIC Option.

Special Features

Feature 5264 -- Long Block Indicator -- provides an indicator in the sense byte to permit the reading of blocks shorter than the block between gaps. The tape will then be automatically advanced to the next gap under electronic control.

Feature 5273 -- Supply Reel Reverse -- permits reading of paper tape wound on the supply reel in either direction.

Feature 5293 -- 4N Terminate -- permits termination of a Read instruction upon recognition of four consecutive N characters (NNNN).

MODEL 8227 PAPER TAPE READER/PUNCH

The RCA 8227 Paper Tape Reader/Punch consists of a 1000 character-per-second reader and a 110 character-per-second punch. Manual controls are provided for selecting the width of the paper tape to be processed. Both the reader and the punch are capable of handling five-, six-, seven-, or eight-level paper tape. Either gap or gapless tape may be processed.

Parity checking is performed by the reader and the punch to control the accuracy of data. The paper tape reader has a switch which can be set to select odd, even, or no-parity checking. A character on paper tape that has bad parity is replaced in memory with the systems error byte hex FF.

The reader/punch handles 11/16-inch, 7/8-inch, or 1-inch paper tape and provides spooling capability for reels up to 1000 feet in length. Paper tape strips may also be read by this device. The following options to the basic paper tape reader/punch are available:

Special Features

Feature 5335 – Four Character Terminate – permits termination of a read instruction upon recognition of four consecutive characters selected by the internal logic. The desired character is selected in a similar fashion to device address selection.

Feature 5336 – Read Kleinschmidt Format – permits reading of punched paper tape which has been punched in accordance with Kleinschmidt conventions relating to media and codes.

Feature 5337 -- End of Tape – provides a program sensible indication upon sensing end-of-tape. It is used in applications requiring strip reading.

Feature 5338 – Gapless Mode – provides the capability of processing punched paper tape which contains character locations that are unpunched (gap characters). The feature allows continuous reading of this media by ignoring the unpunched areas.

Feature 5339 – Punch Kleinschmidt Format – permits punching of unpunched paper tape which is to be prepared in accordance with Kleinschmidt conventions relating to media and codes.

Section 3: CARD AND MICR DEVICES

GENERAL

A wide variety of card-handling devices capable of reading (punched cards) and punching (into cards) or control of reading from MICR documents is provided within the RCA Series peripheral family. Varying speeds, reading and punching recognition capability, and card-handling techniques are provided by the RCA Series systems. This section presents a concise overview of these configurable devices for the RCA Series processors.

MODEL 8232 CARD READER

The RCA 8232 is a serial, punched hole, or punched hole and mark-sense card reader which is capable of feeding and reading standard 80-column cards at a rate of 300 cards per minute or 600 cards per minute. Hopper and stacker capacity is 1000 cards. Both the hopper and stacker can be loaded or unloaded while the unit is in operation.

Special Features

Feature 5204-2 – Binary Card Read – provides the ability to read 80-column cards in column-binary format.

Feature 5340 – 600 Cards Per Minute – provides the ability to read at a rate of 600 cards per minute.

Feature 5341-1 – Vertical Mark Read – Provides the ability to optically read vertical pencil-mark data.

Feature 5341-2 – Slant Mark Read – provides the ability to optically read slant pencil-mark data.

MODEL 8234 CARD PUNCH

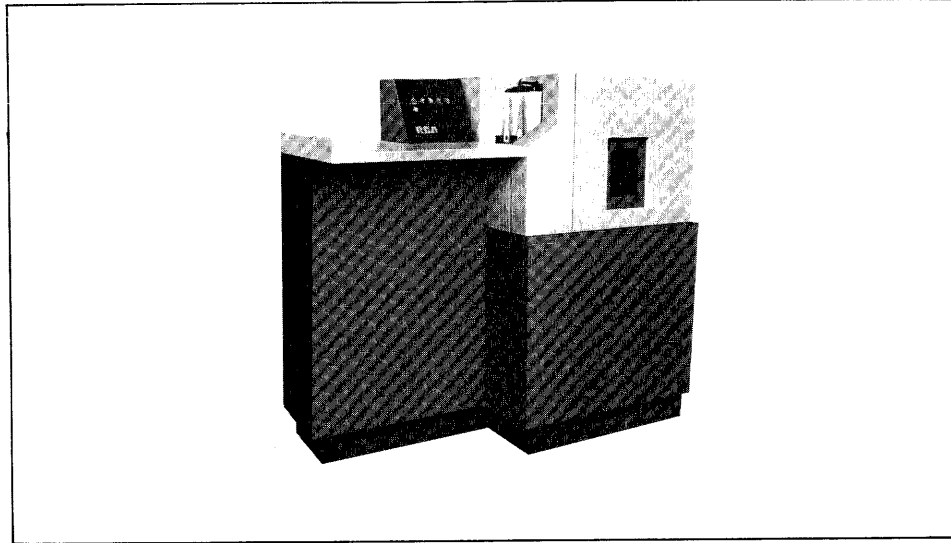

The RCA 8234 Card Punch is an 80-column, row-oriented card punch unit. It is capable of feeding, punching, and checking cards at a rate of up to 100 cards per minute. The 8234 contains an 80-byte storage buffer which provides temporary storage for punched data so that card punching operations can be performed independently of the processor.

Data transmitted between the buffer and the punch is checked for parity. A read-after-punch feature is provided to give a hole-count accuracy check on the punched data. Card-operated switches indicate hopper-empty or stacker-full conditions. Both the hopper and stacker have a capacity of up to 800 cards and can be loaded while the device is operating.

A translation process is performed by the card punch to translate the Extended Binary-Coded-Decimal Interchange Code (EBCDIC) character configurations to the Extended Hollerith card code. The following option to this model card punch is available:

Column Binary – This option provides the ability to punch all possible punch-configurations within a single card.

The following model numbers apply to the 8234 Card Punch:

8234-010 Card punch

8234-011 Card punch with the capability of punching cards in column-binary format.

Special Features

Feature 5213 – Scored Card – provides the ability to accept cards which have been scored for subsequent separation into two or more cards.

MODEL 8236 CARD PUNCH

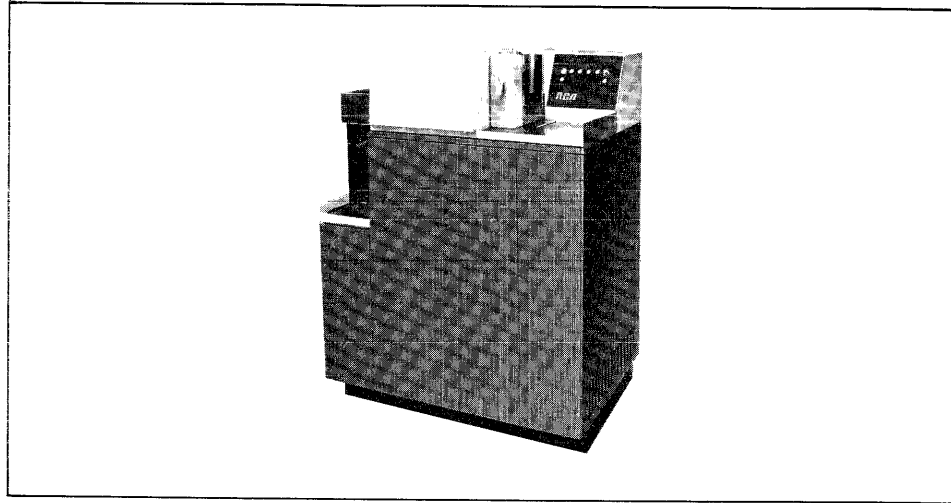

The RCA 8236 Card Punch is an 80-column, row-oriented card punch capable of feeding, punching and checking 80-column cards at a rate of up to 300 cards per minute. An 80-byte storage buffer which is loaded asynchronously at a rate of up to 120 kilobytes per second permits card punching to be performed independently of the processor.

Data is constantly monitored during transmission from the processor to the buffer and from the buffer to the punch. A read-after-punch function is provided to give a hole-count accuracy check on punched data.

A translation process is performed by the card punch, to translate the Extended Binary-Coded-Decimal Interchange Code (EBCDIC) character configuration into Extended Hollerith card code. All 256 possible code configurations can be punched.

The hopper capacity is 1000 cards and the two selectable stackers have a capacity of 850 cards each. The device may be loaded while it is operating.

The following model numbers apply to the 8236 Card Punch:

8236-010 Card punch.

8236-011 Card punch with the ability to punch cards in column-binary format.

Special Features

Feature 5215-1,2 – Scored Card – provides the ability to accept cards which have been scored for subsequent separation into two or more cards.

Feature 5261-1, 2 – Programmed Stacker Select – permits software to route the cards to be punched to either the reject or normal stacker.

MODEL 8237 CARD READER

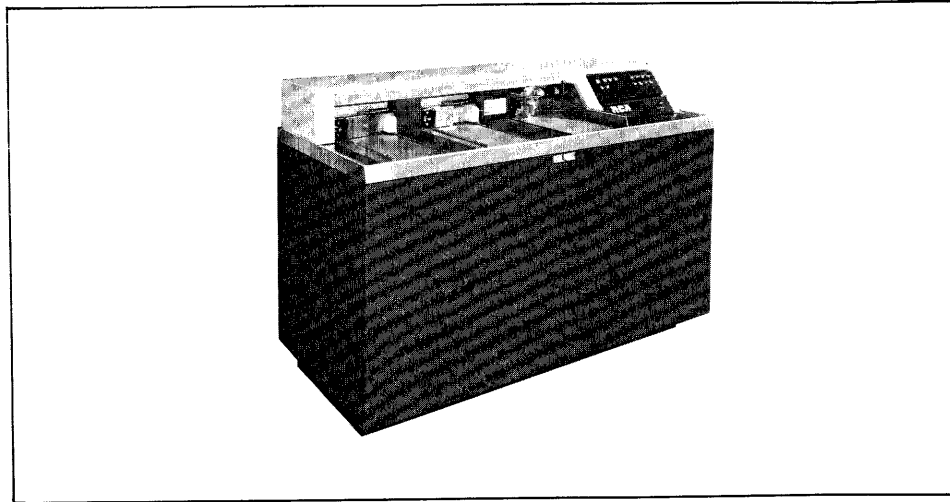

The RCA 8237 Card Reader reads standard 80-column punched cards at rates up to 1435 cards per minute. Cards are read column-by-column and maximum speeds can be obtained on a demand-basis.

The hopper has a capacity of 2000 cards. Cards may be routed under program control to one of two selectable stackers. Each stacker holds up to 2000 cards. Loading and unloading of the reader are permitted while the device is running.

This reader is a self-powered device containing all necessary reading, timing, control, and accuracy-checking circuitry. The reader translates the Extended Hollerith card code into Extended Binary-Coded-Decimal Interchange Code (EBCDIC). Any punched hole combination for which there is no corresponding machine-code byte causes the systems error byte hex FF to be generated, and transferred to memory.

The following option to this model card reader is available:

Optical Mark Read – This option provides the capability of reading pencil-mark data from an 80-column card. With this option the reader has the following possible modes of operation:

1. Read punched-hole data only (CR).
2. Read pencil-mark data only (MR).
3. Read punched-hole and pencil-mark data (CR and MR).

The mode of operation is selected at the operator's console, and any one of these modes is possible in any one document pass.

The following model numbers apply to the 8237 card reader.

8237-010 Basic card reader (1435 cards per minute).

- 8237-021 Basic card reader with the ability to read vertical pencil marks.
- 8237-022 Basic card reader with the ability to read slanted pencil marks.

Special Features

Feature 5202 – 51-Column Card – provides the ability to read 51- or 80-column cards.

Feature 5204-1 – Column Binary – provides the ability to read 80-column cards in a column-binary format.

Feature 5211-1 – End of File – provides automatic end-of-file indication and is available for the 1401 and 1410 Emulator. The feature permits the card reader to inform the processor that an end-of-file condition has occurred.

Feature 5269 – Column 81 Inhibit – inhibits detection of read errors due to punches in column 81.

MODEL 8272 MICR SORTER-READER CONTROLLER

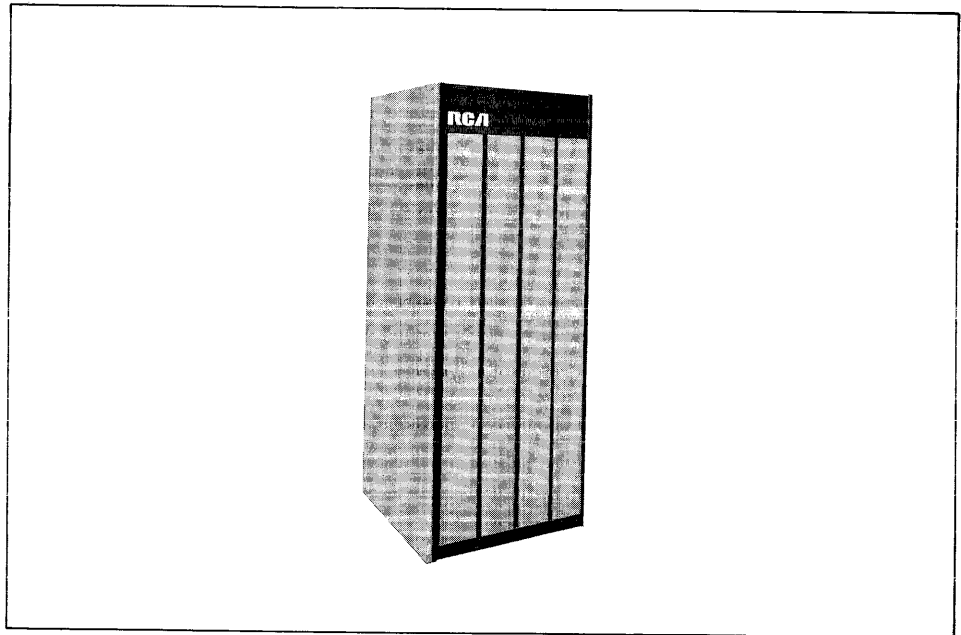

The RCA 8272 Magnetic Ink Character Recognition (MICR) Controller provides the ability to operate one of several MICR sorter-readers at speeds up to 1600 documents per minute. The 8272 with a sorter-reader can sort documents into 13 or 18 program selectable pockets.

The following model numbers apply to the 8272 MICR Controller:

- 8272-010 With an RCA system, this controller operates a Burroughs B-103 or B-116 MICR Sorter-Reader.
- 8272-020 With an RCA system, this controller operates an IBM 1419 MICR Sorter-Reader.
- 8272-030 With an RCA system, this controller operates an NCR 407 MICR Sorter-Reader.

GENERAL

The following RCA Series printers present a complete series of advanced electromechanical printing devices offering varying speeds, form-handling capability, character-set, and print-line capacities.

MODEL 8242 MEDIUM SPEED PRINTER

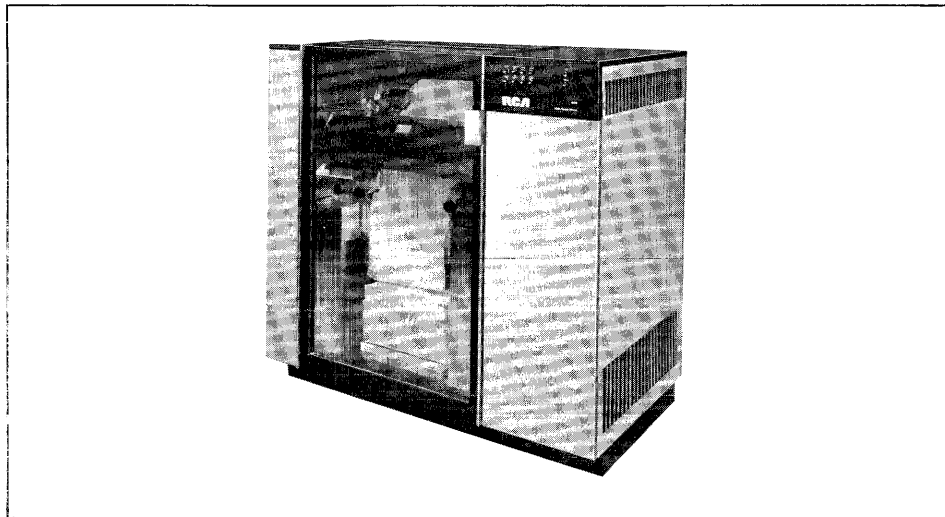

The RCA 8242 Medium Speed Printer, is a fully buffered, drum-type printer which prepares printed output documents at the speed of 625 lines per minute. A single data line contains 132- or 160-print positions depending on the model number. A selected 64-character subset of the Extended Binary-Coded-Decimal Interchange Code (EBCDIC) may be printed.

A controller in the printer provides the means for communicating among the printer, print buffer, and the RCA standard interface.

On command from the processor, a data line (any number of characters up to 132 or 160) is transferred from the processor to the buffer. When the buffer is loaded, printing is performed independently of the processor.

Vertical paper movement can be accomplished by a paper tape loop control, program control, or a combination of both. Single line paper-advance time is less than 12 milliseconds, and vertical tab rate is 27 inches per second.

The printer is capable of handling edge-perforated, fan-folded paper and card stock. Form widths may be 4 inches to 18 3/4 inches, including margins.

Data is checked during transmission from the processor to the buffer and from the buffer to the printer. An indication is sent to the processor when a low-paper condition is detected or when a character which is not included in the 64-character subset is detected in the buffer.

Characteristics

| <u>Printer Model</u> | <u>Speed (lines/minute)</u> | <u>Printer Graphics</u> | <u>Print Positions</u> |
|----------------------|-----------------------------|-------------------------|------------------------|
| 8242-030 | 625 | 64 | 132 |
| 8242-040 | 625 | 64 | 160 |

The following special features are applicable to all Model 8242 Printers:

5221, 5225, 5226, 5227, 5228, 5229, 5262, 5274, 5275, 5278, 5287, 5332, 5333.

Special Features

Feature 5221 – Dual Speed Form Advance – increases the form advance slew rate for line skips in excess of eight lines (for six-lines-per-inch spacing) and ten lines (for eight-lines-per-inch spacing).

Feature 5225 – Special Character – covers a one-time charge per character for evaluation and development of special print characters which have not been previously developed for the printer.

Feature 5226 – Print Drum Tooling – covers a one-time charge for tooling required to produce a special print drum. If special character development is necessary, Feature 5225 is also required.

Feature 5227-1, 2 – Print Drum Segment Set – provides a special print drum, and one spare segment for use in place of the standard print drum.

Feature 5228 – Print Drum Segment – provides a spare print drum segment identical to those which were previously supplied by prerequisite Feature 5227.

Feature 5229-1, 2 – Videoscan Print Drum Segment Set – replaces the standard print drum with a drum containing the 14 Videoscan N-2 font characters.

Feature 5262-3 – Document Processing Operation – permits the applicable printer to control an IBM 9361 Document Converter.

Feature 5274 – Line Counter – modifies a printer to maintain a count of lines printed. The counter indicator is visible to operating personnel and is manually resettable.

Feature 5275 – Financial Print Drum Segment Set – replaces the standard print drum with a drum containing the three special financial characters: CR, DB, and OD.

Feature 5278-30 – Format Control – modifies the printer to operate in an IBM System 1401 type format control.

Feature 5287-1, 2 – Puerto Rican Print Drum Symbol Set – replaces the standard print drum with a drum containing two special characters (\tilde{n} , \tilde{i}). They are substituted on the drum for standard characters with no other changes in the character array.

Feature 5332-1 – ANSCII Print Drum Segment Set – replaces the standard print drum with one containing the three special ANSCII characters (open and close brackets, and reverse slant). They are substituted on the drum for standard characters with no other change in the character array.

Feature 5333 – Form Stacker – provides refolding capability under positive control for all forms used on this printer (7 inches to 17 inches long, 4 inches to 18 3/4 inches wide). The current stacking tray is used as a receptacle for the refolded paper and the stacker paper guide chutes which can be adjustable vertically to accommodate a stack height of approximately 12 inches.

MODEL 8243 HI-SPEED PRINTER

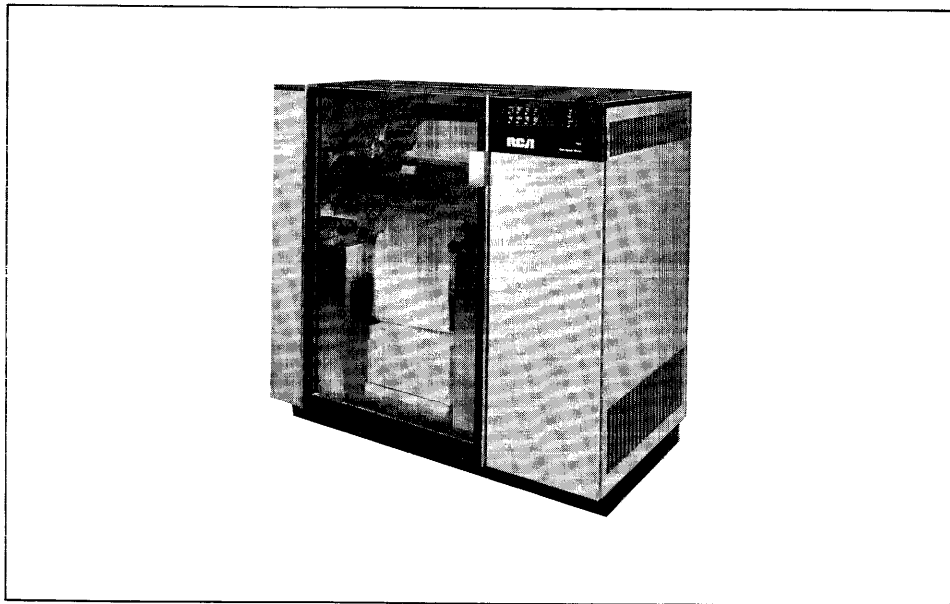

The RCA 8243 Hi-Speed Printer, is a fully buffered, drum-type printer which prepares printed documents at rates up to 1250 lines per minute. A single line contains 132- or 160-print positions depending on the model number. Selected 64-character or 96-character subsets of the Extended Binary-Coded-Decimal Interchange Code (EBCDIC) may be printed.

A controller in the printer provides the means for communicating among the printer, print buffer, and the RCA standard interface. On command from the processor, a data line (any number of characters up to 132 or 160) is transferred from the processor to the buffer. When the buffer is loaded, printing is performed independently of the processor.

Vertical paper movement can be accomplished by a paper tape loop control, program control, or a combination of both. Single-line paper-advance time is less than 12 milliseconds and vertical-tab rate is 75 inches per second.

The printer is capable of handling edge-perforated, fan-folded paper and card stock. Form widths may be 4 inches to 18 3/4 inches, including margins.

Data is checked during transmission from the processor to the buffer and from the buffer to the printer. An indication is sent to the processor when a low-paper condition is detected or when a character which is not included in the 64-character or 96-character subset is detected in the buffer. Various fonts are available as special features.

Characteristics

| <u>Printer Model</u> | <u>Speed (lines/minute)</u> | <u>Printer Graphics</u> | <u>Print Positions</u> |
|----------------------|-----------------------------|-------------------------|------------------------|
| 8243-030 | 1250 | 64 | 132 |
| 8243-040 | 1250 | 64 | 160 |
| 8243-051 | 833 | 96 | 132 |
| 8243-061 | 833 | 96 | 160 |

The following special features are applicable to the Models 8243-030 and 8243-040 Printers:

5225, 5226, 5227, 5228, 5229, 5262, 5274, 5275, 5278, 5287, 5332, and 5333.

The following special features are applicable to the Models 8243-51 and 8243-61 Printers:

5225, 5226, 5227, 5228, 5262, 5274, 5278, and 5333.

Special Features

Feature 5221 – Dual Speed Form Advance – increases the form advance slew rate for line skips in excess of eight lines (for six-lines-per-inch spacing) and ten lines (for eight-lines-per-inch spacing).

Feature 5225 – Special Character – covers a one-time charge per character for evaluation and development of special print characters which have not been previously developed for the printer.

Feature 5226 – Print Drum Tooling – covers a one-time charge for tooling required to reproduce a special print drum. If special character development is necessary, Feature 5225 is also required.

Feature 5227-1, 2 – Print Drum Segment Set – provides a special print drum, and one spare segment for use in place of the standard print drum.

Feature 5228 – Print Drum Segment – provides a spare print drum segment identical to those which were previously supplied by prerequisite Feature 5227.

Feature 5229-1, 2 – Videoscan Print Drum Segment Set – replaces the standard print drum with a drum containing the 14 Videoscan N-2 font characters.

Feature 5262-3 – Document Processing Operation – permits the applicable printer to control an IBM 9361 Document Converter.

Feature 5274 – Line Counter – modifies a printer to maintain a count of lines printed. The counter indicator is visible to operating personnel and is manually resettable.

Feature 5275 – Financial Print Drum Segment Set – replaces the standard print drum with a drum containing the three special financial characters: CR, DB, and OD.

Feature 5278 – Special Format Control – modifies the printer to operate in an IBM 1402 type format control.

Feature 5287-30 – Puerto Rican Print Drum Symbol Set – replaces the standard print drum with a drum containing two special characters (\tilde{n} , \acute{e}). They are substituted on the drum for standard characters with no other changes in the character array.

Feature 5332-1 – ANSCII Print Drum Segment Set – replaces the standard print drum with a drum containing the three special ANSCII characters (open and close brackets, and reverse slant). The characters are substituted on the drum for standard ones, with no other change in the character array.

Feature 5333 – Form Stacker – provides refolding capability for all forms used on this printer (7 inches to 17 inches long, 4 inches to 18 3/4 inches wide). The current stacking tray is used as a receptacle for the refolded paper and the stacker paper guide chutes are adjustable vertically to accommodate a stack height of approximately 12 inches.

MODEL 8244 TRAIN PRINTER

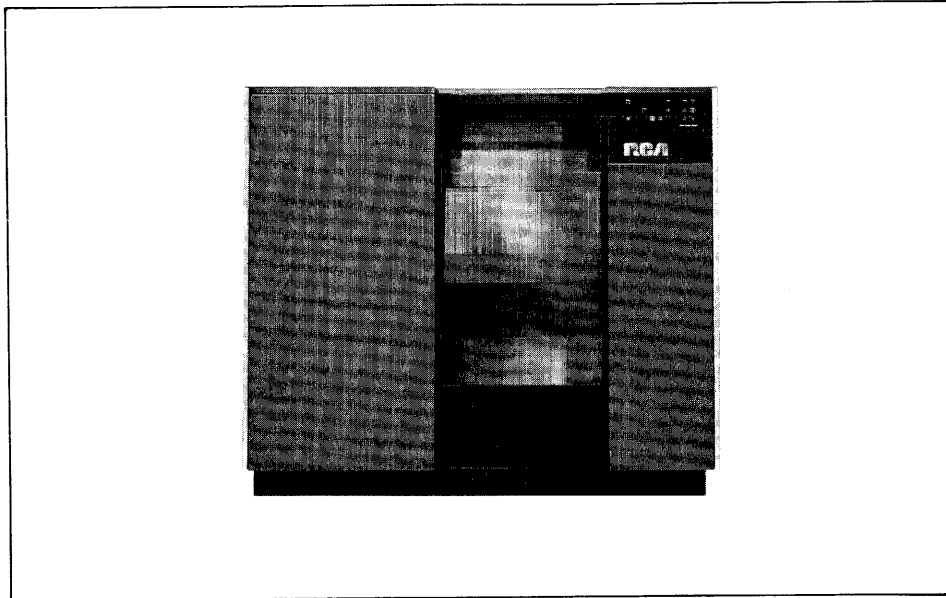

The RCA 8244 is an impact-type train printer. The printer consists of the necessary components which enable it to print as typographical characters, the character-serial information supplied by an associated control electronics by way of a processor.

Printing is done in page format, on single or multiple-part, marginally-punched, continuous fan-folded paper forms or card stock.

The RCA 8244 is a quietized free-standing unit, with associated control electronics and employs an RCA Model Train Cartridge, equivalent to, and interchangeable with the IBM Model 1416 Train Cartridge. The 8244-200 will single space six lines per inch at 1200 lines per minute, and the 8244-100, 600 lines per minute with 48 character sets used in the RCA or IBM cartridge. Higher rates may be obtained with optimized character sets. Single line spacing may be set by the operator at six or eight lines per vertical inch. The horizontal print line is composed of 132 printing positions spaced at 10 characters to the inch.

Operator controls are provided to control print density, forms thickness and forms adjustment. Control mechanism also enable program control of form movement vertically and to control ribbon feeding, reversing and skew. Printer set-up controls allow the operator to align the paper form and the format control data independently.

The format loop is used on set-up only to load a special buffer. The loop does not move with the form, providing greater loop reliability and life. The format loop sensing mechanism is capable of reading all standard 12-channel tape loops. Alternately, no format loop is required. Format data can be read into the buffer from the processor by special program control.

Operator Controls

Print Density

Vertical Forms Position

Paper Tension - Horizontal

Ribbon Replacement

Format Loop Replacement

End of Forms Sensing

Forms Breakage Sensing

Vertical Line Spacing

First Line Locator

Single Control Horizontal Forms Positioner – All four tractors

Characteristics

| <u>Printer Model</u> | <u>Speed (lines/minute)</u> | <u>Printer Graphics</u> | <u>Print Positions</u> |
|----------------------|-----------------------------|-------------------------|------------------------|
| 8244-200 | 1200 | 48 | 132 |
| 8244-100 | 600 | 48 | 132 |

MODEL 8248 BILL FEED PRINTER

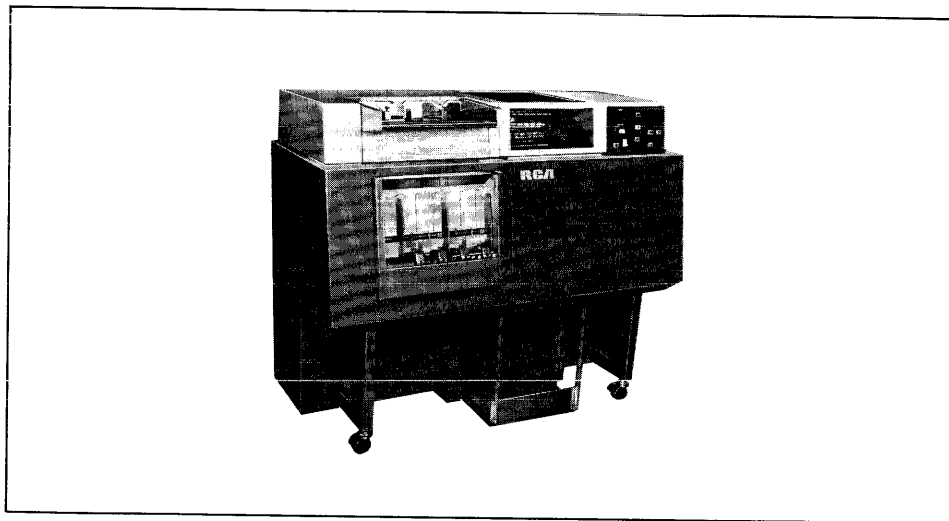

The RCA 8248 Bill Feed Printer prints on continuous forms at effective rates up to 600 lines per minute; or on card documents at rates up to 800 lines per minute (400 cards for each of the two feed channels).

A movable print unit allows the operator to easily change from continuous-forms feeding to card-document feeding. Conveniently-located controls, hoppers, and stackers, all accessible from the front, permit easy operation.

The Model 8248 can process cards ranging from a single 51-column card to an 80-column card stub. It can also process any two cards, that range in size from 51 to 80 columns each, at one time. The hopper and stackers can accommodate 1200 standard tab cards. Up to 25 lines of data, either from processor storage or the card itself, can be printed on a card. A standard 48-character set consisting of 26 alphabetic, 10 numeric, and 12 special characters, may be printed.

Special Features

Feature 5216 – Interchangeable Chain Cartridge Adapter – provides a print chain cartridge adapter to permit print chain interchangeability. Two interchangeable chain cartridges are supplied, one replacing the permanent chain and one additional chain.

MODEL 8249 BILL FEED PRINTER CONTROLLER

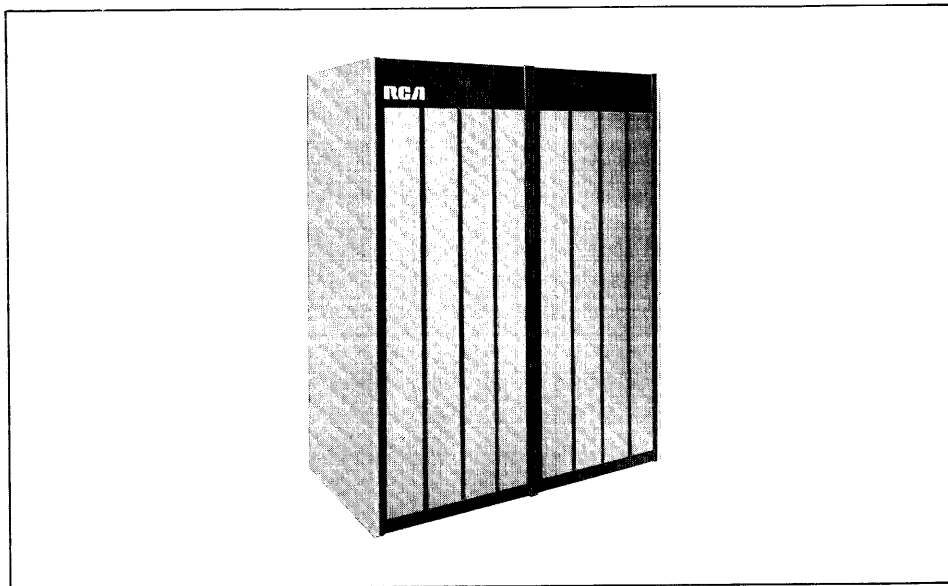

A RCA 8249 Bill Feed Printer Controller is required with the Model 8248 Bill Feed Printer. The following option to the basic bill feed printer and controller is available:

Read-Compare – Read and storing of up to 30 columns from the 160 (two cards) columns is available as an option. Selection of the desired 30 columns is accomplished by means of an operator-wired plugboard.

GENERAL

The RCA Series offers a wide range of industry-compatible magnetic tape devices. As with other peripheral equipment, the magnetic tape stations or tape units are connected to the processor by way of an input/output channel, a tape device controller, and the RCA standard interface. The tape stations are single tape deck devices with control equipment. The tape units consist of two tape stations. The magnetic tape controllers are either single channel or dual channel. The single channel controller connects to only one input/output channel of the processor and provides for only one input or output operation at a time. The dual channel controller connects to two input/output channels of the processor and provides for simultaneous operation of two tape stations (for example, read-read, read-write, write-write). The tape stations, tape units, and tape controllers can be connected in various combinations as described in this section.

The RCA Series provides tape devices which operate in the 1600 bits-per-inch, phase-encoding mode as well as devices which operate in the 800 bits-per-inch non-return to zero (NRZ) mode. Models to handle either 7-track or 9-track tape are available. All of the tape devices incorporate extensive error detection and accuracy control features.

MODEL 8432 MAGNETIC TAPE UNIT

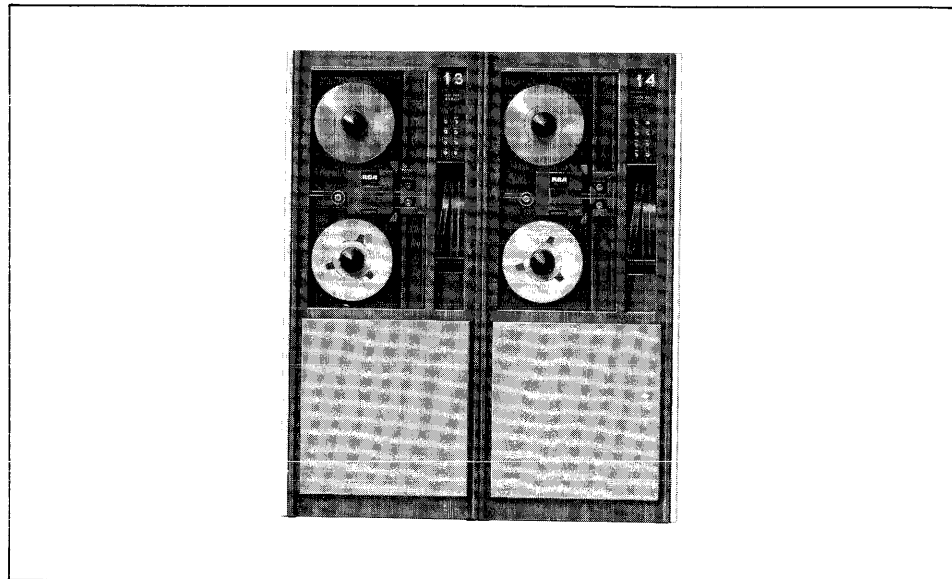

The RCA 8432 Magnetic Tape Unit consists of two tape stations contained in one 48-inch wide rack. The Model 8432-001 permits single-channel tape

station operation while the Model 8432-002 permits dual-channels operations (read-read, read-write, and write-write) of two tape stations.

Each tape station of the Model 8432 is capable of reading and writing 1/2-inch, 9-track, magnetic tape at the rate of 30,000 bytes per second. Reading is possible in the forward or reverse direction. Writing and erasing may be accomplished in the forward direction only. The Model 8432 Magnetic Tape Unit is completely compatible with all 9-track, NRZI, IBM 2400 Series tape units.

Characteristics

| | |
|--------------------------|-------------------------|
| Data Rate: | 30 kilobytes per second |
| Tape Speed: | 37.5 inches per second |
| Tape Rewind Speed: | 100 inches per second |
| Average Start/Stop Time: | 16 milliseconds |
| Recording Density: | 800 bits per inch |
| Nominal Gap: | 0.6 inch |
| Reel Diameter: | 10.5 inches |
| Number of Feet per Reel: | 2400 |
| Parity: | Odd |

The Model 8432 Magnetic Tape Unit can operate with the tape controllers listed below:

| <u>Tape Unit</u> | <u>Tape Controller</u> |
|------------------|---|
| 8432-001 | 8472-108,-116 8473-108,-116 8476-108,-116 (requires Feature 5431-1) |
| 8432-002 | 8472-208,-216 8473-208,-216 8476,208,-216 (requires Feature 5431-2) |

Feature 5411-1, 2 – Seven-Track Tape Feature – permits reading and writing 7-track tape in IBM 727/729 seven track tape format. Recording density can be specified at 200, 556, or 800 bits per inch providing a 7500, 20,850, or 30,000 character-per-second transfer rate, respectively. Odd or even parity may be specified.

Feature 5465 – 7/9 Track Tape Feature – converts one of the two tape stations in a Model 8432-002 Tape Unit from 9-track format to 7-track format.

MODEL 8442 MAGNETIC TAPE UNIT

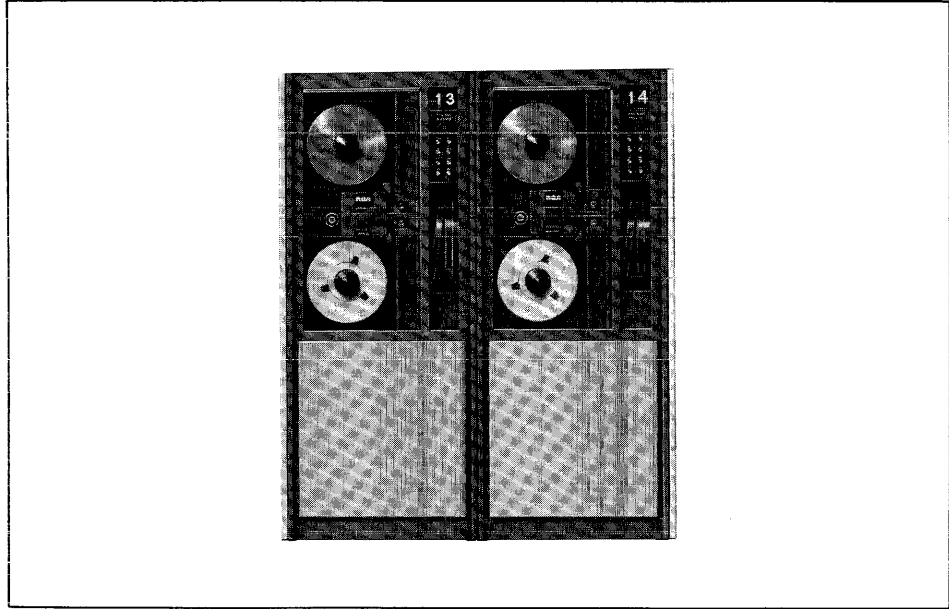

The RCA 8442 Magnetic Tape Unit consists of two tape stations contained in one 48-inch wide rack. The Model 8442-001 permits single tape station operation, while the Model 8442-002 permits simultaneous operations (read-read, read-write, write-write) of both tape stations.

Each Model 8442 tape station is capable of reading and writing ½-inch, 9-track, magnetic tape at the rate of 60,000 bytes per second. Reading is possible in the forward or reverse direction. Writing and erasing may be accomplished in the forward direction only. The Model 8442 Magnetic Tape Unit is completely compatible with all 9-track, NRZI IBM 2400 Series tape units.

Characteristics

| | |
|--------------------------|-------------------------|
| Data Rate: | 60 kilobytes per second |
| Tape Speed: | 75 inches per second |
| Tracks: | 9 |
| Tape Rewind Speed: | 150 inches per second |
| Average Start/Stop Time: | 8 milliseconds |
| Recording Density: | 800 bits per inch |
| Nominal Gap Size: | 0.6 inch |
| Reel Diameter: | 10.5 inches |
| Number of Feet per Reel: | 2400 |
| Parity: | Odd |

The Model 8442 Magnetic Tape Unit can operate with the tape controllers listed below:

| <u>Tape Unit</u> | <u>Tape Controller</u> |
|------------------|---|
| 8442-001 | 8472-108,-116 8473-108,-116 8476-108,-116 (requires Feature 5431-1) |
| 8442-002 | 8472-208,-216 8473-208,-216 8476-208,-216 (requires Feature 5431-2) |

Special Features

Feature 5412-1, 2 – Seven-Track Tape Feature – Permits reading and writing 7-track tape in IBM 727/729 seven-track tape format. Recording density can be specified at 200, 556, or 800 bits per inch providing a 15,000, 41,700, or 60,000 character-per-second transfer rate, respectively. Odd or even parity may be specified. This feature requires a Model 8473 Tape Controller.

Feature 5464 – 7/9-Track Tape Feature – converts one of the two tape drives in a Model 8442 from the 9-track format to the 727/729 track tape format, leaving the other drive unchanged as 9-track.

MODEL 8445 MAGNETIC TAPE STATION

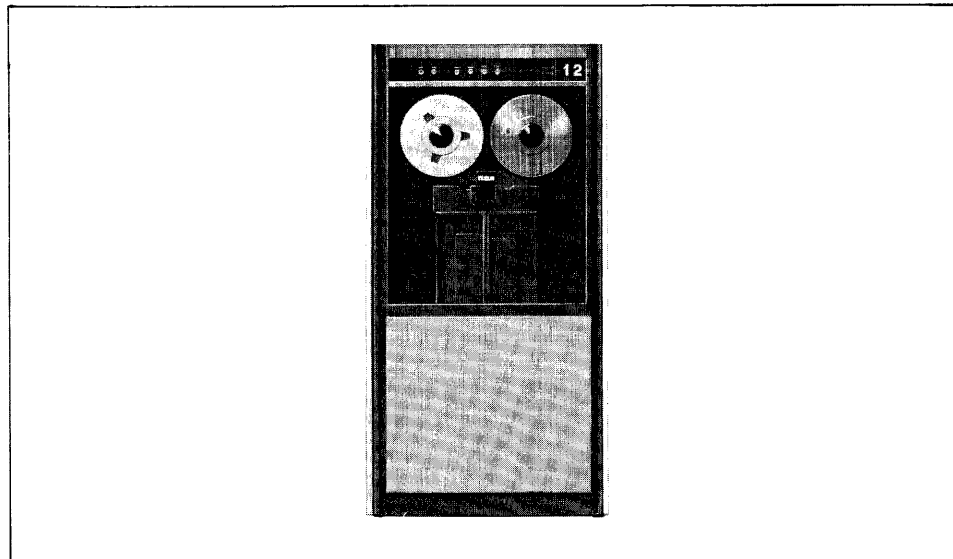

The RCA 8445 Magnetic Tape Station is capable of reading and writing ½-inch, 9-track, magnetic tape at the rate of 120,000 bytes per second. The Model 8445-002 Magnetic Tape Station is identical to the 8445-001 with the exception that the 8445-002 permits simultaneous tape operations (read-read, read-write, write-write) with another tape station.

Reading is possible in the forward or reverse direction. Writing and erasing may be accomplished in the forward direction only. The Model 8445 Magnetic Tape Station is completely compatible with all 9-track NRZI, IBM 2400 Series tape units.

Characteristics

| | |
|--------------------------|-------------------------------------|
| Data Rate: | 120 kilobytes per second |
| Tape Speed: | 150 inches per second |
| Tape Rewind Speed: | 400 inches per second |
| Average Start/Stop Time: | 6 milliseconds |
| Recording Density: | 800 bits per inch |
| Nominal Gap Size | 0.6 inch reading, 0.65 inch writing |
| Reel Diameter: | 10.5 inches |
| Number of Feet per Reel: | 2400 |
| Parity: | Odd |

The Model 8445 Tape Station can operate with the tape controllers listed below:

| <u>Tape Station</u> | <u>Tape Controller</u> |
|---------------------|---|
| 8445-001 | 8472-108,-116 8473-108,-116 8476-108,-116 (requires Feature 5431-2) |
| 8445-002 | 8472-208,-216 8473-208,-216 8476-208,-216 (requires Feature 5431-2) |

Special Features

Feature 5413-1, 2 – Seven-Track Tape Feature – permits reading and writing 7-track tape in IBM binary or binary-coded-decimal mode. Recording density can be specified at 200, 556, or 800 bits per inch providing a 30,000, 83,400, or 120,000 character-per-second transfer rate, respectively. Odd or even parity may be specified. Feature 5413 requires a 8473 Tape Controller.

Feature 5463 – Run to the BT Marker – modifies the 8445 so that momentary operation of the LOAD control causes a station loaded with 7- or 9-track tape to go to the beginning of tape marker.

MODEL 8451 MAGNETIC TAPE UNIT

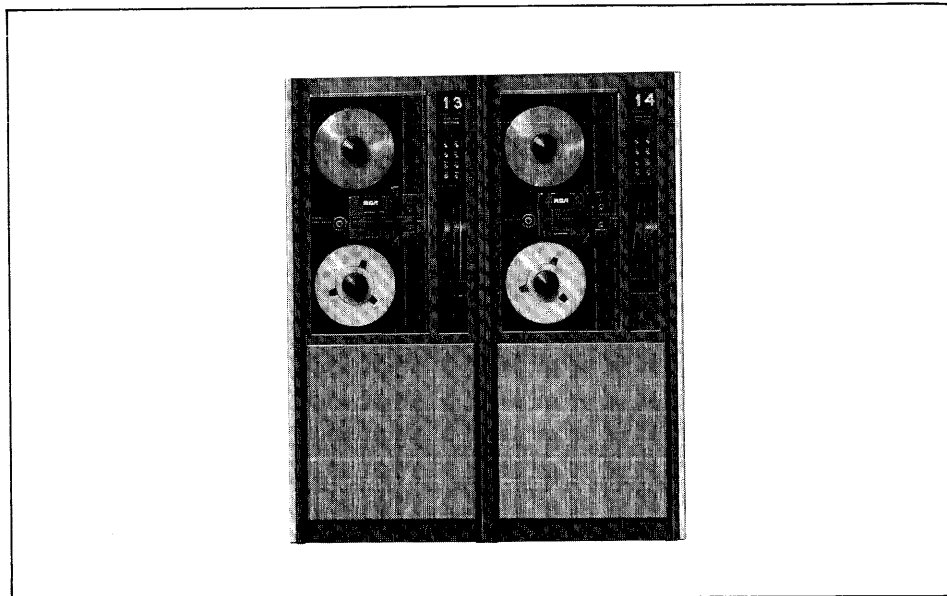

The RCA 8451 Magnetic Tape Unit consists of two 9-track tape stations mounted in a single 48-inch wide rack. The tape stations can read or write 1600 bits-per-inch, phase-encoded tape. Reading can be done in either the forward or reverse direction. Writing or erasing is done in the forward direction only. The 8451-002 provides for simultaneous operations (read-read, read-write, write-write) of both tape stations in the unit. The 8451 can read tape written by the IBM 2400 Series phase-encoding units and write tape to be read by these units.

Characteristics

| | |
|--------------------------|------------------------------------|
| Data Rate: | 60 kilobytes per second |
| Tracks: | 9 |
| Tape Speed: | 37.5 inches per second |
| Tape Rewind Speed: | 225 inches per second |
| Recording Density: | 1600 bits per inch, phase encoding |
| Tape Width: | 0.5 inch |
| Gap Size: | 0.6 inch |
| Reel Diameter: | 10.5 inches |
| Number of Feet per Reel: | 2400 |

The Model 8451 Magnetic Tape Unit can operate with the tape controllers listed below:

| <u>Tape Unit</u> | <u>Tape Controller</u> |
|------------------|------------------------|
| 8451-001 | 8476-108,-116 |
| 8451-002 | 8476-208,-216 |

MODEL 8453 MAGNETIC TAPE UNIT

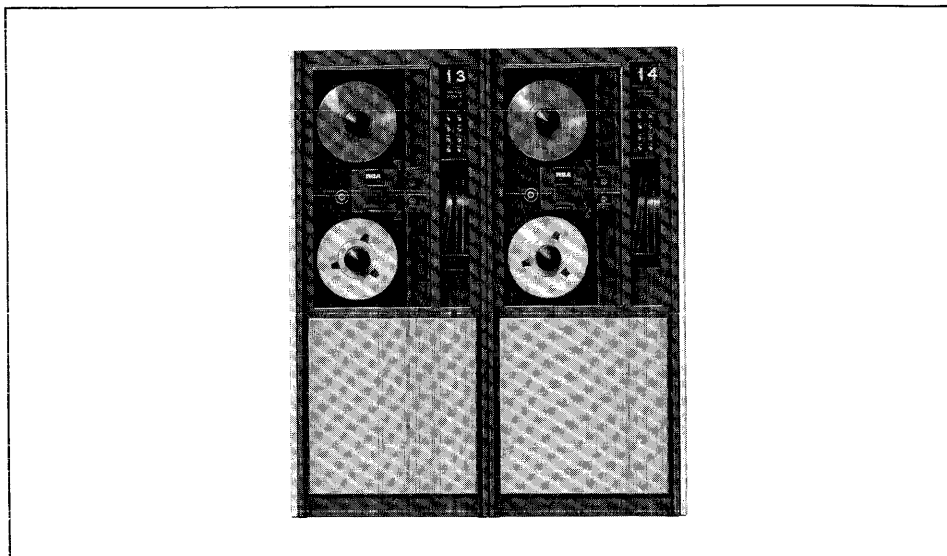

The RCA 8453 Magnetic Tape Unit consists of two 9-track tape stations mounted in a single 48-inch wide rack. The tape stations can read or write 1600 bits-per-inch, phase-encoded tape. Reading can be done in the forward or reverse direction. Writing or erasing is done in the forward direction only. The 8453-002 provides for simultaneous operations (read-read, read-write, write-write) of both tape stations in the unit. The 8453 can read tape written by the IBM 2400 Series phase-encoding units and write tape to be read by these units.

Characteristics

| | |
|--------------------------|-------------------------------------|
| Data Rate: | 120 kilobytes per second (1600 bpi) |
| Tracks: | 9 |
| Tape Speed: | 75 inches per second |
| Tape Rewind Speed: | 350 inches per second |
| Recording Density: | 1600 bits-per-inch, phase-encoding |
| Tape Width: | 0.5 inch |
| Gap Size: | 0.6 inch |
| Reel Diameter: | 10.5 inches |
| Number of Feet per Reel: | 2400 |

The Model 8453 can operate with the tape controllers listed below:

| <u>Tape Unit</u> | <u>Tape Controller</u> |
|------------------|------------------------|
| 8453-001 | 8476-108,-116 |
| 8453-002 | 8476-208,-216 |

MODEL 8457 MAGNETIC TAPE STATION

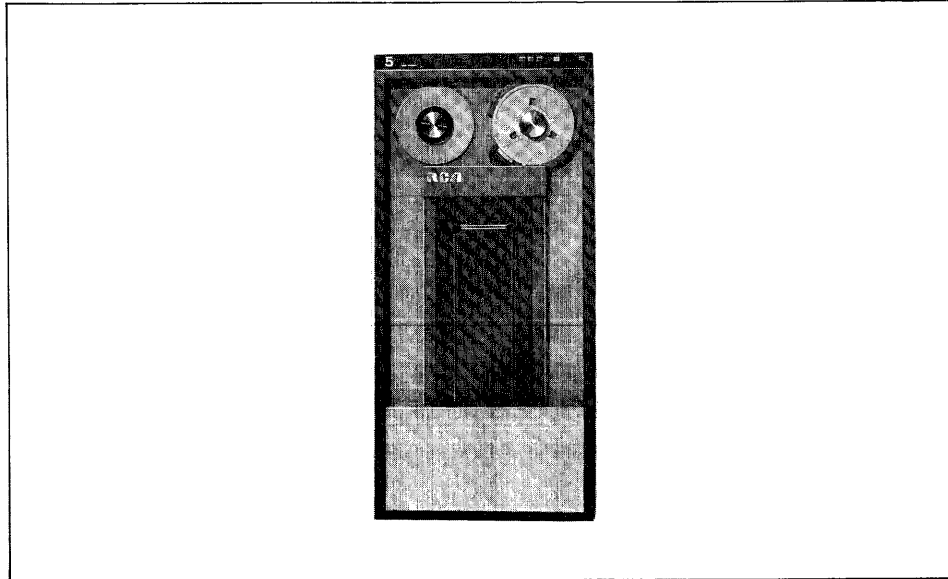

The RCA 8457 Magnetic Tape Station is a high-performance, high-density, phase-encoded station capable of reading and writing ½-inch, 9-track magnetic tape at a rate of 160,000 bytes per second. Reading is possible in the forward or reverse direction. Writing or erasing is accomplished in the forward direction only. The RCA 8457 is a standard industry-compatible 1600-bpi station which offers the same features that are available in the IBM 2420 Series. Some key advantages are:

1. Ability to accept magnetic tape cartridges as well as standard tape reels.
2. Automatic tape loading.
3. Power window controlled by the operator at loading time.

Characteristics

| | |
|---------------|------------------------------------|
| Data Rate: | 160 kilobytes per second |
| Tape Speed: | 100 inches per second |
| Gap Size: | 0.6 inch |
| Tracks | 9 |
| Tape Parity: | Odd |
| Tape Density: | 1600 bits-per-inch, phase-encoding |

The RCA 8457 Magnetic Tape Station operates with the RCA 8478-108,-116, or 8478-208,-216 Tape Controller.

MODEL 8459 MAGNETIC TAPE STATION

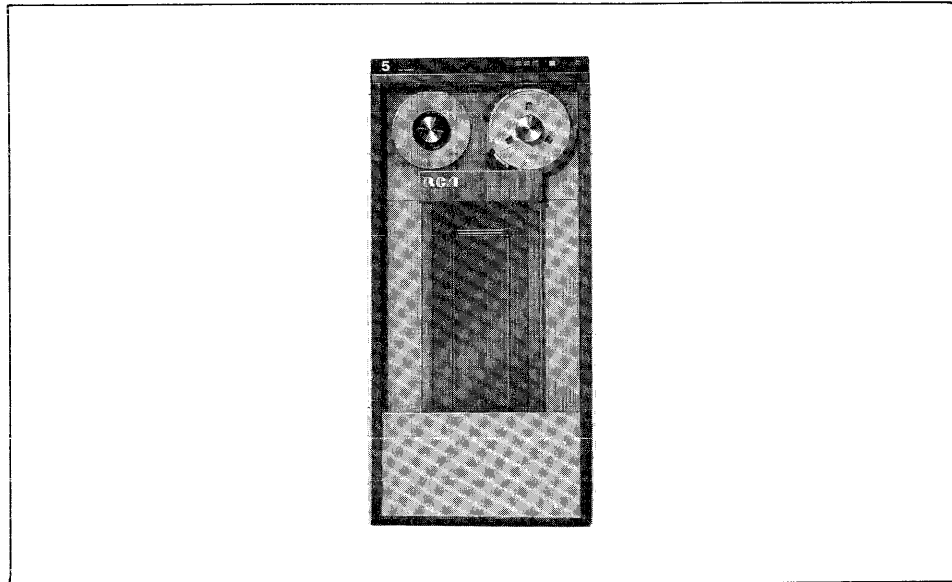

The RCA 8459 Magnetic Tape Station is a high-performance, high-density, phase-encoded station capable of reading and writing ½-inch, 9-track magnetic tape at a rate of 320,000 bytes per second. Reading is possible in the forward or reverse direction. Writing or erasing is accomplished in the forward direction only. The RCA 8459 is a standard industry-compatible, 1600-bpi station which offers the same features that are available in the IBM 2420 Series. Some key advantages are:

1. Ability to accept magnetic tape cartridges as well as standard tape reels.
2. Automatic tape loading.
3. Power window controlled by the operator at loading time.

Characteristics

| | |
|---------------|-----------------------------------|
| Data Rate: | 320 kilobytes per second |
| Tape Speed: | 200 inches per second |
| Gap Size: | 0.6 inch |
| Tracks: | 9 |
| Tape Parity: | Odd |
| Tape Density: | 1600 bits per inch phase encoding |

The RCA 8459 Magnetic Tape Station operates with the RCA 8478-108,-116,208 or 216 Tape Controller.

MODEL 8472 TAPE CONTROLLER

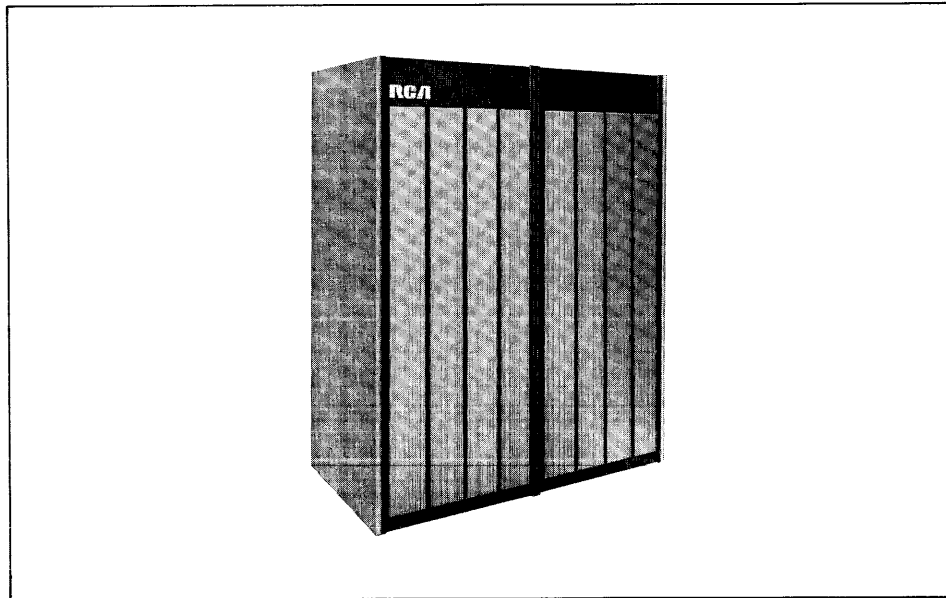

The RCA 8472-108 or -116 Tape Controller is a single-channel controller that can control up to 8 (-108) or 16 (-116), 9-track tape stations. Any combination of 8432-001, 8442-001, or 8445-001 Tape Devices can be operated by this tape controller.

The Model 8472-208, or -216 Tape Controller is a dual-channel controller that can control up to 8 (-208) or 16 (-216) 9-track tape stations. Any combination of 8432-002, 8442-002, or 8445-002 Tape Devices can be operated by this tape controller. Any two tape stations on the 8472-208 or -216 can operate simultaneously (read-read, read-write, write-write).

Special Features

Feature 5449-1, 2 – Word Mark Mode – modifies a tape controller to operate on processors equipped with the 1401 or 1410 Emulator (Feature 5046 or 5026 respectively) installed. Feature 5449-1 is applicable to the 8472-108, or -116. Feature 5449-2 is applicable to the 8472-208, or -216.

MODEL 8473 TAPE CONTROLLER

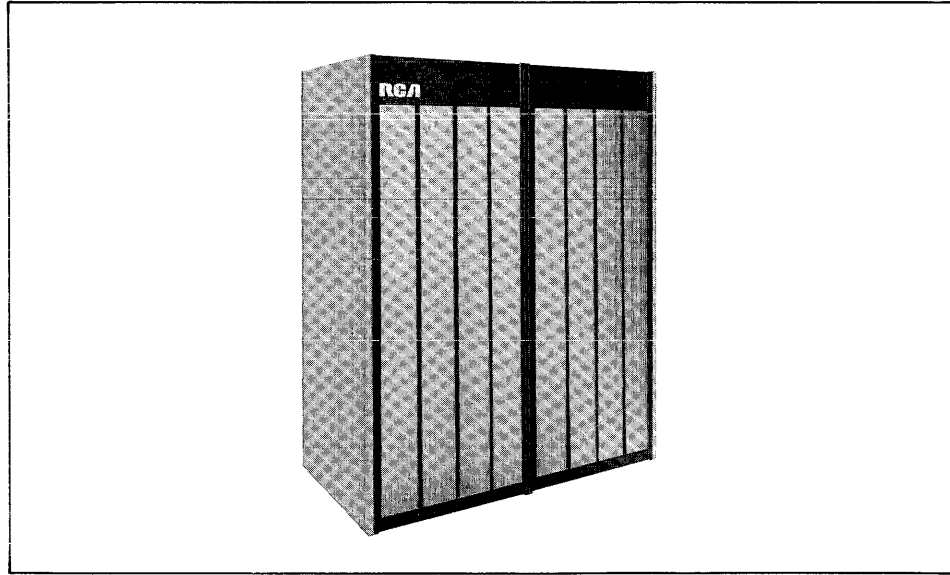

The RCA 8473-108, or -116 Tape Controller is a single-channel controller that can control up to 8 (-108) or 16 (-116), 7-track or 9-track tape stations. Any combination of 8432-001, 8442-001, or 8445-001 Tape Devices can be operated by this tape controller.

The Model 8473-208, or -216 Tape Controller is a dual-channel controller that can control up to 8 (-208) or 16 (-216) 7-track or 9-track tape stations. Any combinations of 8432-002, 8442-002, or 8445-002 Tape Device can be operated on this tape controller. Any two tape stations on the 8473-208, or -216 can operate simultaneously (read-read, read-write, write-write).

Special Features

Feature 5402-1, 2 – Pack/Unpack – converts four 6-bit characters on tape to three 8-bit characters in memory when reading, or conversely when writing. Feature 5402-1 is applicable to the 8473-108, or -116. Feature 5402-2 is applicable to the 8473-208, or -216.

Feature 5450-1, 2 – Word Mark Mode – modifies a tape controller to operate on a Model RCA 2 Processor with the 1401 or 1410 Emulator (Feature 5026 or 5046 respectively) installed. Feature 5450-1 is applicable to the 8473-108, or -116. Feature 5450-2 is applicable to the 8473-208, or -216.

MODEL 8476 TAPE CONTROLLER

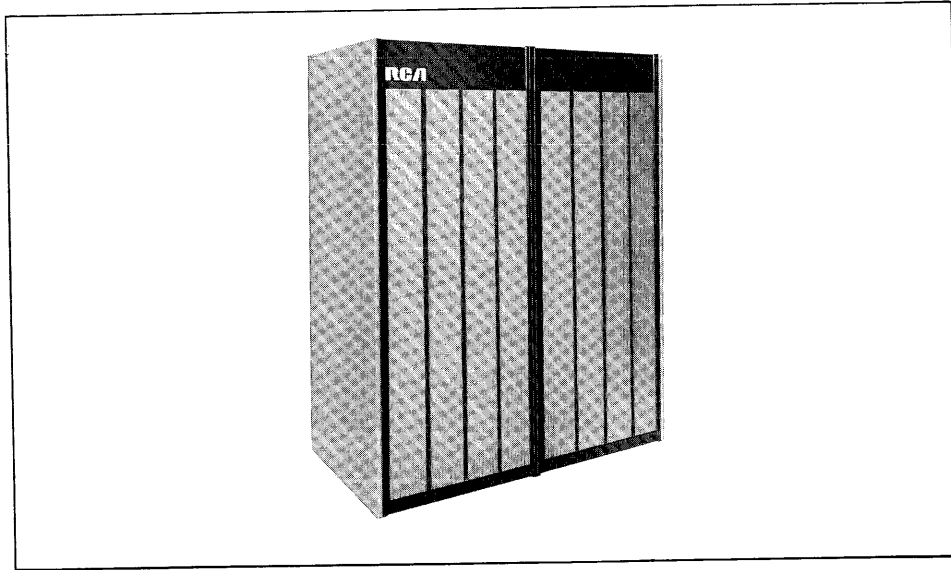

The RCA 8476 Tape Controller -108, or -116 is a single-channel controller that can control up to 8 (-108) or 16 (-116) 1600 bpi, phase-encoding, 9-track, tape stations. Any combination of 8432-001, 8442-001, 8445-001, 8451-001 or 8453-001 Tape Devices can be operated by this tape controller (see Feature 5431).

The Model 8476-208, or -216 is a dual-channel controller that can control up to 8 (-208) or 16 (-216) 1600 bpi, phase-encoding, 9-track, tape stations. Any combination of 8432-002, 8442-002, 8445-002, 8451-002 or 8453-002 Tape Devices can be operated by this tape controller (see Feature 5431). Any two tape stations on the 8476-208, or -216 can operate simultaneously (read-read, read-write, or write-write).

Special Features

Feature 5431-1, 2 – Nine-track Non-Return-to-Zero (NRZ) provides for the 8476 to control 9-track 800 bpi NRZ mode tape devices. Feature 5431-1 is applicable to the 8476-108, or -116 and provides for control of 9-track tape devices (8432-001, 8442-001, and 8445-001). Feature 5431-2 is applicable to the 8476-208, or -216 and provides for control of 9-track tape devices (8432-002, 8442-002, and 8445-002).

Feature 5452 – Word-Mark Mode – modifies the 8476 to operate on processors equipped with the 1401 or 1410 Emulator (Feature 5046 or 5026 respectively) installed. Feature 5452-1 is applicable to the 8476-108, or -116. Feature 5452-2 is applicable to the 8476-208, or -216.

MODEL 8478 TAPE CONTROLLER

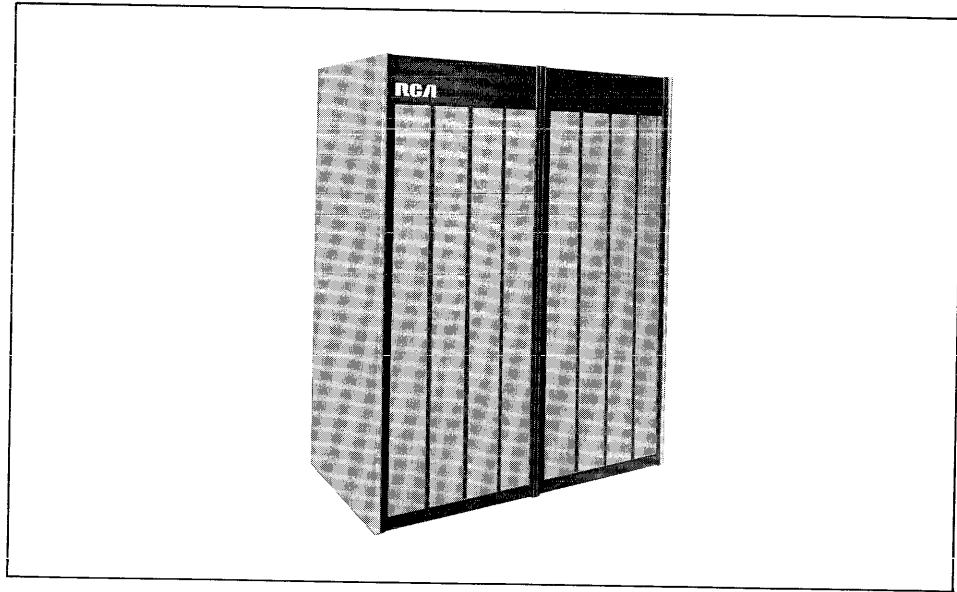

The RCA 8478-108, -116 is a single-channel controller that can control up to 8 (-108) or 16 (-116) high-density (1600 bpi) phase-encoded tape stations. Any combination of the 8457 and 8459 Magnetic Tape Stations can be connected to this tape controller.

The RCA 8478-208, -216 is a dual-channel controller that can control up to 8 (-208) or 16 (-216) high-density (1600 bpi) phase-encoded 8457 and 8459 Magnetic Tape Stations in any combination. Any two tape stations can operate simultaneously (read-read, read-write, write-write) on the Model 8478-208, -216 Tape Controller.

GENERAL

The RCA Series Random Access equipment offers a complete line of peripheral devices and controllers which complement any system configuration.

Modular extensions of RCA Series equipment is provided by offering: drums, discs, and cards associated with dedicated and nondedicated controllers; control up to 16 devices, each to provide the media which establishes the criteria required for a large data base.

Intermixing of different devices which appear transparent to software, and common language for each device, ease the programmer into large complex systems.

Comprehensive accuracy checks performed by the appropriate controller insure data integrity and confidence expected by the user.

MODEL 8551 RANDOM ACCESS CONTROLLER

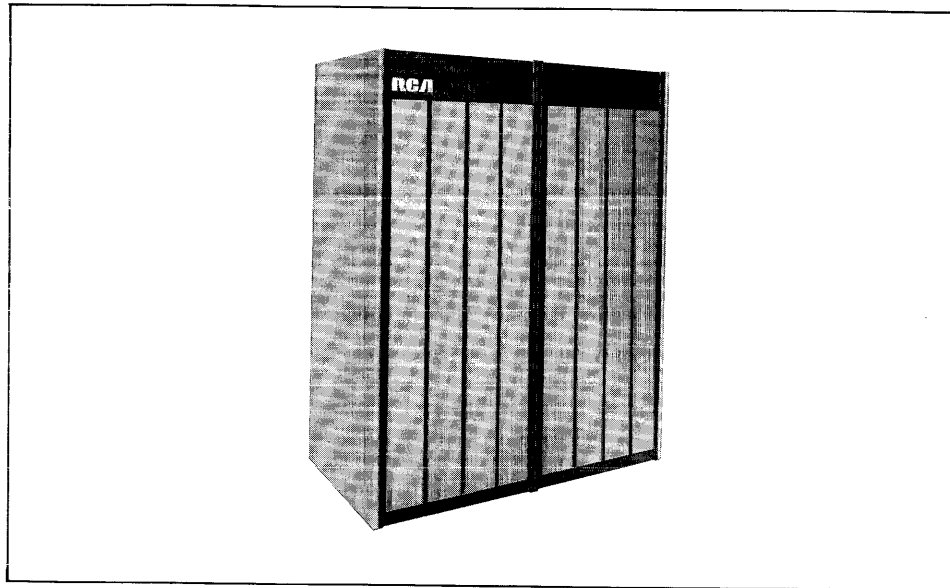

The Model 8551 Random Access Controller operates random-access devices in the RCA Series. The following devices are operated by the 8551: Model 8564 Disc Storage Unit, Model 8567 Drum Memory Unit, and Model 8568 Mass Storage Unit.

Intermixing of different devices on one controller is permitted, but from a programming viewpoint, all devices look the same. The controller has a standard set of commands which it translates into specific commands for each of the different devices. The seeking or selecting of specific locations within a file is performed independently of the processor. Facilities for locating a particular data record are also provided by the controller.

The controller maintains a comprehensive accuracy check on data being read and written. The data integrity is confirmed by the addition of two check characters to the trailing end of each recorded block.

Special Features

Feature 5501-11, 14, 18 – Input/Output Attachment for 8564 – allows the 8551 to operate the following numbers of Model 8564 Disc Storage Units: Feature 5501-11, one unit; Feature 5501-14, four units; Feature 5501-18, eight units.

Feature 5502-1 – Input/Output Attachment for 8568 – allows the 8551 to operate up to eight Model 8568 Mass Storage Units.

Feature 5508 – Input/Output Attachment for 8567 – allows the 8551 to operate one Model 8567-008 or one Model 8567-016 Drum Memory.

Feature 5511 – File Scan – provides an automatic rapid search of the key and data fields for a specific identifier or condition. This feature is operated under program control.

Feature 5512 – Record Overflow – allows a logical data record to overflow from one track to another, but not across cylinder boundaries. This feature is operated under program control.

Feature 5513-2 – Multichannel Switch – provides an electronic switch to allow the 8551 to be switched under program control between two selector channels. The channels may be located in the same or separate processors.

MODEL 8560 VIRTUAL MEMORY STORAGE SYSTEM

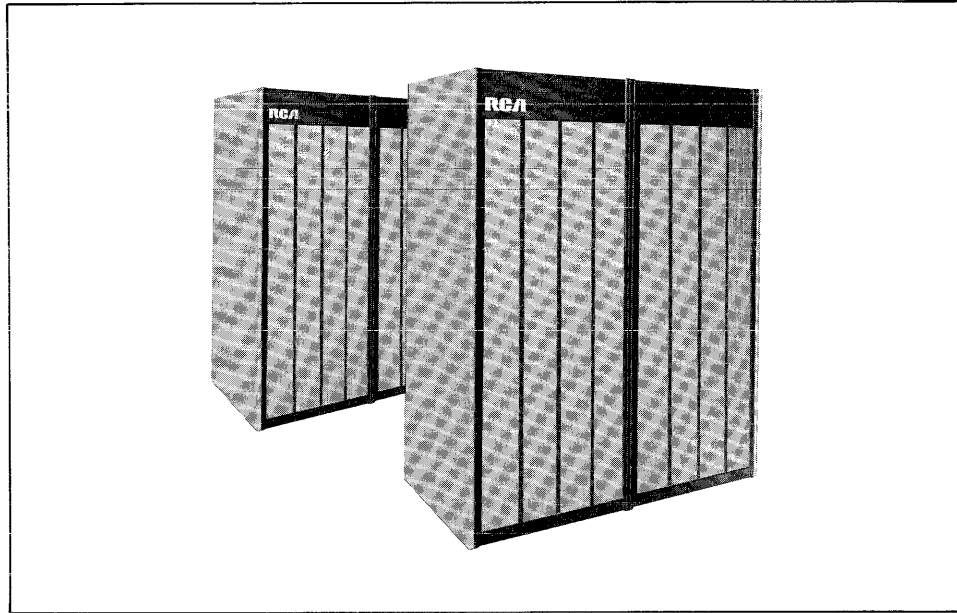

The RCA 8560 Virtual Memory Storage System is a high-performance device which provides fast, direct-access storage for the RCA 3 and RCA 7 Virtual Memory Systems.

The RCA 8560 consists of a 512-track, 800-track, or 1600-track drum and a random access controller. The controller is attached to a trunk on a selector channel. All input/output functions are done by the controller and data is passed to and from the processor by way of the selector channel trunk. With the RCA 8560 it is possible to have from 2.1 to 6.5 million bytes of on-line storage.

Characteristics

| | <u>8560-005</u> | <u>8560-008</u> | <u>8560-016</u> |
|--|------------------------------------|------------------------------------|------------------------------------|
| Tracks/Drum | 512 | 800 | 1600 |
| Bytes/Track | 4096 | 4096 | 4096 |
| Megabytes/Drum | 2.09 | 3.277 | 6.554 |
| Rotational Speed (revolutions/minute) | 2600 | 3600 | 3600 |
| Rotational Time (milliseconds) | 17.2 | 17.2 | 17.2 |
| Latency (milliseconds) | 8.6 | 8.6 | 8.6 |
| Access Time (milliseconds) | 0 (min) 8.6 (avg) 17.9 (max) | 0 (min) 8.6 (avg) 17.9 (max) | 0 (min) 8.6 (avg) 17.9 (max) |
| Transfer Rate (kilobytes/second) | 333 | 333 | 333 |

MODEL 8564 DISC STORAGE UNIT

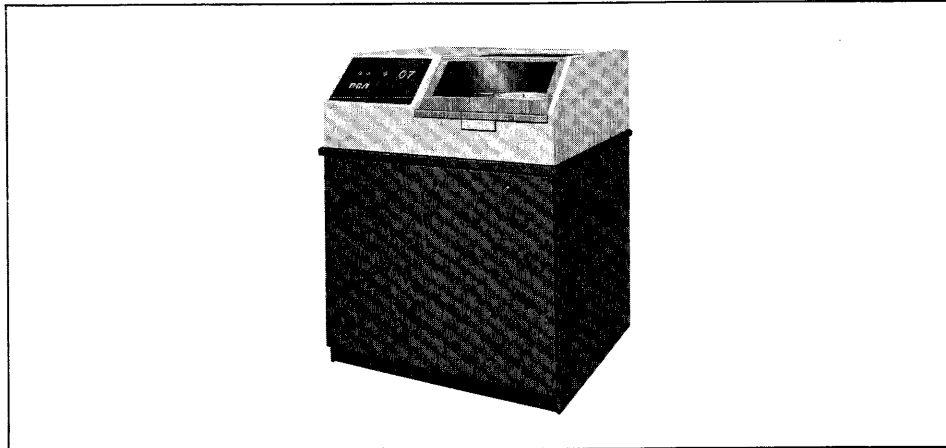

Model 8564 Disc Storage Unit provides random-access storage for 7.25 million bytes of information on an interchangeable disc pack. The operation of this device is controlled by the Model 8551 Random Access Controller, and up to eight units may be attached to one controller.

The disc pack consists of 203 tracks per disc surface and has 10 tracks under the read/write heads at one time. There is a total of 2030 tracks per disc pack. Each track contains 3625 bytes (maximum is one data record per track) producing a total information capacity of 7.25 million bytes per disc pack.

Data is transferred between the processor and the disc at the rate of 156,000 bytes per second. The track-to-track access is 25 milliseconds. The average seek time is 75 milliseconds, with a range of from 25 to 135 milliseconds. Since the discs rotate at 2400 revolutions/minute, there is an average latency of 12.5 milliseconds.

All accuracy control and data validity checking for the Disc Storage Unit are performed in conjunction with the 8551 Random Access Controller.

MODEL 8567 DRUM MEMORY UNIT

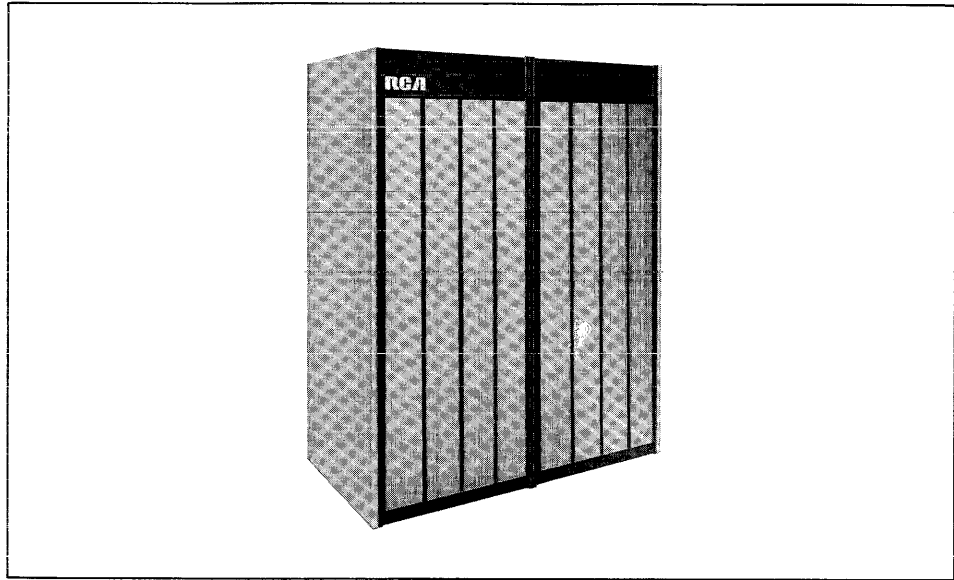

The 8567 Drum Memory Unit consists of a magnetic data drum and its associated control electronics. Two models of the drum are available: the 8567-008 holds over 4.12 million bytes and consists of 800 tracks, and the 8567-016 holds over 8.25 million bytes and consists of 1600 tracks. The storage capacity of each track is 5161 bytes and each track has an associated read/write head. A drum speed of 3600 revolutions/minute produces an average access time of 8.6 milliseconds. Data is transferred at 333,000 bytes/second.

Operation of the Drum Memory Unit is controlled by the 8551 Random Access Controller. All accuracy control and data validity checking for the device are performed in conjunction with the 8551 Controller.

MODEL 8568 MASS STORAGE UNIT

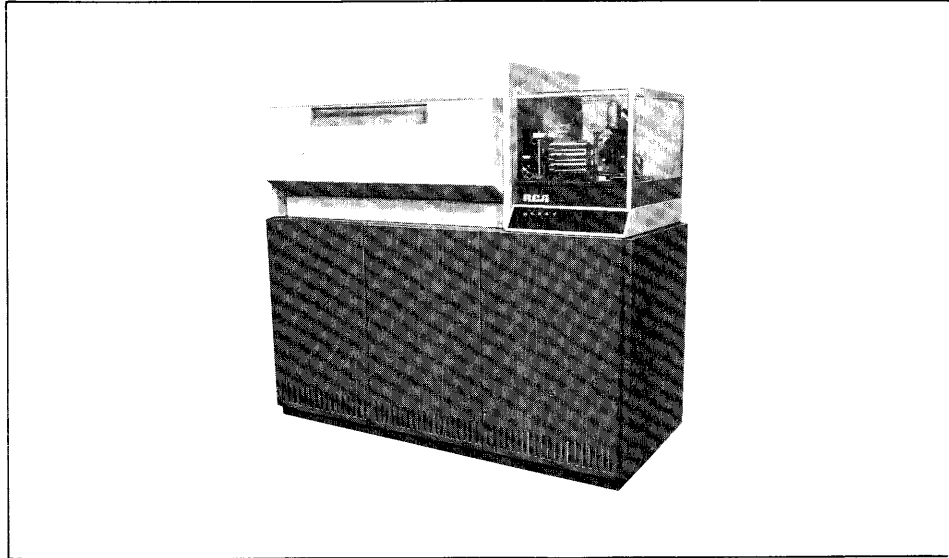

The RCA Mass Storage Unit consists of a mass storage retrieval unit and associated control electronics. The operation of this device is controlled by the Model 8551 Random Access Controller. The Model 8568 consists of from one to eight removable magazines. Up to eight 8568 units may be attached to a 8551 Random Access Controller, providing multibillion-byte storage capacity, on-line, at low cost.

The basic storage medium of the mass storage unit is a 16-inch by 4½-inch magnetic card. Data is recorded on one side of the card only. Each Model 8568 card contains 128 separately addressable tracks of 2048 bytes each. There are 256 cards housed in each magazine.

A card is removed from a magazine and enters a raceway over which it is transported to a read/write station (revolving capstan). At the read/write station the card passes beneath a set of eight read/write heads where data is either read or recorded. The read/write station includes a gate which controls the recirculation or return of the card to its associated magazine. The RCA 8568 has read-after-write capability.

All accuracy control and data validity checking for the 8568 are performed in conjunction with the Model 8551 Random Access Controller.

MODEL 8590 DIRECT ACCESS STORAGE SYSTEM

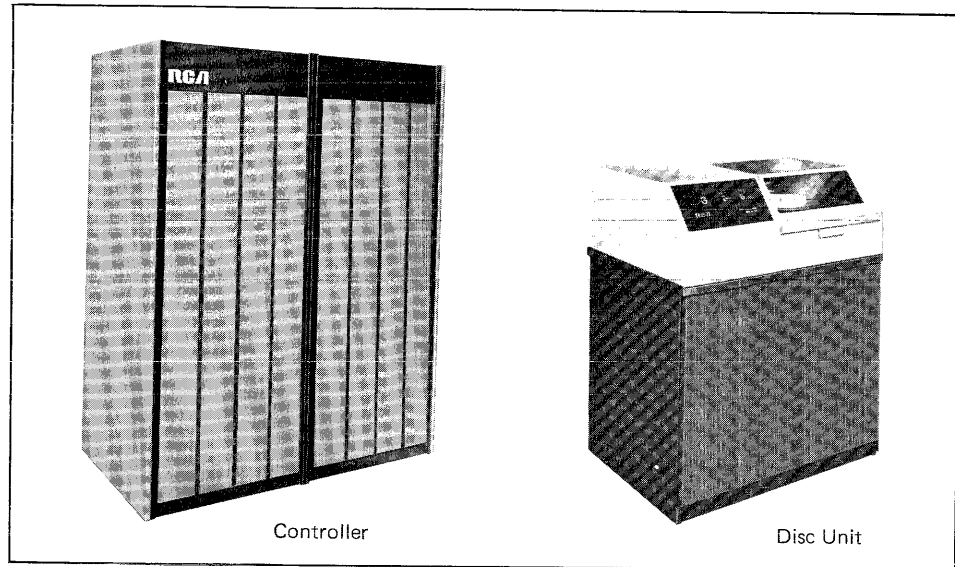

The RCA 8590 Direct Access Storage System consists of a Direct Access Controller and its associated Disc Units. Each of the disc units can hold in excess of 29 million bytes. An RCA 8590 system can be configured to have two to sixteen disc units for a total storage of from 58 to 466 million bytes. For each configuration of eight units, a spare disc drive is provided. This means that for a 8590-008, there are nine physical disc drives, and for a 8590-016, there are 18 physical disc drives. (The spare disc drives are not on-line.) Each of the disc units mounts a removable RCA 511 Disc Pack comparable to the IBM 2316 Disk Pack which is used with the IBM 2314 Disk File. These Disc Packs are hardware interchangeable between the Model 8590 Disc Units and the IBM 2314 Disk Files.

The RCA 8590 System operates on a selector channel in a one-by-eight configuration. The system allows the Channel to Read, Write, or Search on any one of the eight on-line disc units. A Multichannel Switch Feature allows the 8590 System to be used by either of two selector channels. The selector channels may be from the same or different processors.

Characteristics

Track capacity (one record per track): 7294 bytes

Cylinder (20 tracks) capacity: 145,880 bytes

Disc Pack (200 cylinders) capacity: 29,176,000 bytes

Access time (one Disc Unit):

Minimum - 25 milliseconds

Average - 60 milliseconds

Maximum - 130 milliseconds

Transfer rate (nominal): 312,000 bytes per second

Special Features

Feature 5519 – Multichannel Switch – This feature allows an RCA 8590 Direct Access Storage System to be used by two selector channels.

Section 7: SWITCHING DEVICES

GENERAL

The RCA Series Switching Devices provide a wide range of switching capability for system configuration flexibility and system backup. Switches can be arranged so that they are either manually or program controlled. The switches are complex in that there are a great many conductors which must be switched and there are a large number of possible configurations. However, in application, they can be viewed as devices which can switch a single data path to any one of two or more other data paths. The switches are considered as 1x2, 1x3, or 1x4, (figure 2-1) indicating that one data path can be switched to one of two, three, or four other data paths. The switches, in some cases, may also be considered in reverse so that one of several data paths can be selected to feed a single data path. Switches are available which permit many processor-to-device controller configurations and also switches which permit a wide variety of configurations with various data communications lines.

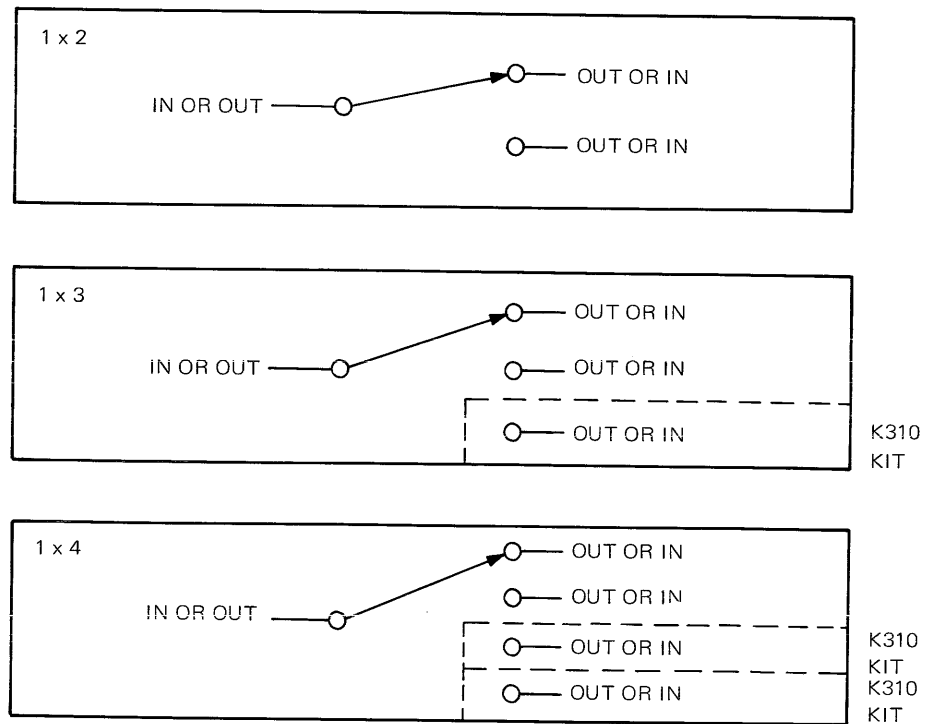
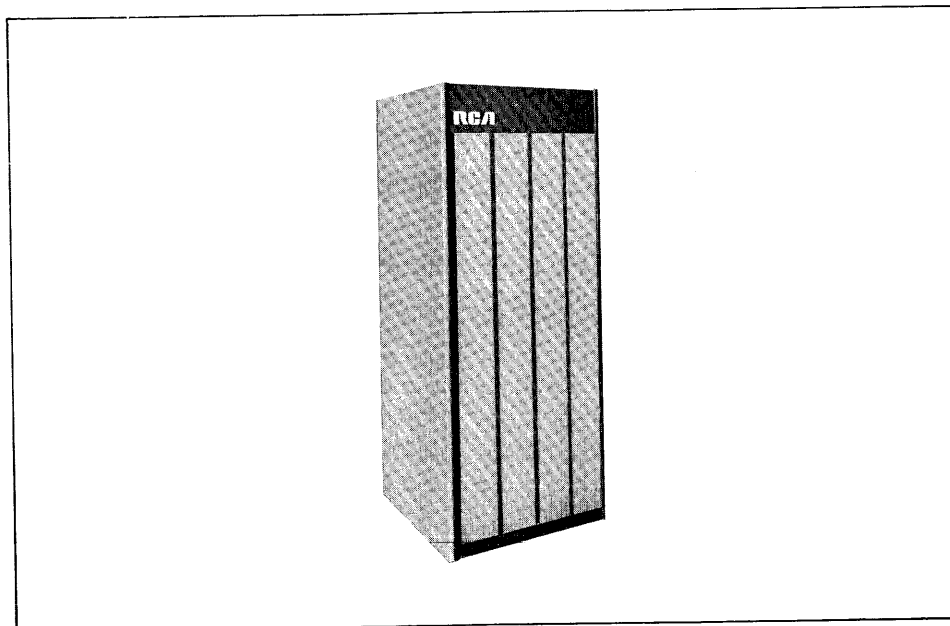

FIGURE 2-1. SCHEMATIC OF 1X2, 1X3, AND 1X4 SWITCHES

MODEL 8310 STANDARD INTERFACE SWITCH



An RCA processor is connected to the individual device controllers by means of the standard interface cable. This standard interface cable, which is made up of 37 pairs of standard-wire conductors, provides a uniform means of connection between the RCA processors and the different types of device controllers which can be used in an RCA system. The Model 8310 Standard Interface Switch provides for the switching of this standard interface cable.

By use of the basic 1x2 Model 8310 switch (figure 2-2A) a device controller can be switched between two processors. With the same switch two device controllers (figure 2-2B) can be switched so that one or the other is connected to one processor. Many variations of this basic switching are possible with the available switch models.

The standard interface switch is housed in a 24-inch x 62-inch cabinet. The cabinet contains the power supply and space is provided for up to eight switches. Space is also provided for a Model 8350 Switch Controller, which is required if switches are to be controlled by the program. Each of the basic switches is a 1x2. However, as shown in table 2-1, kits are available to expand any or all of the switches to either 1x3 or 1x4. Additional 1x2 switches may be added to any Model 8310 cabinet, up to the maximum of eight, by ordering the model and suffix (see table 2-1) with the required number of switches and indicating the model number of the Model 8310 cabinet to be expanded.

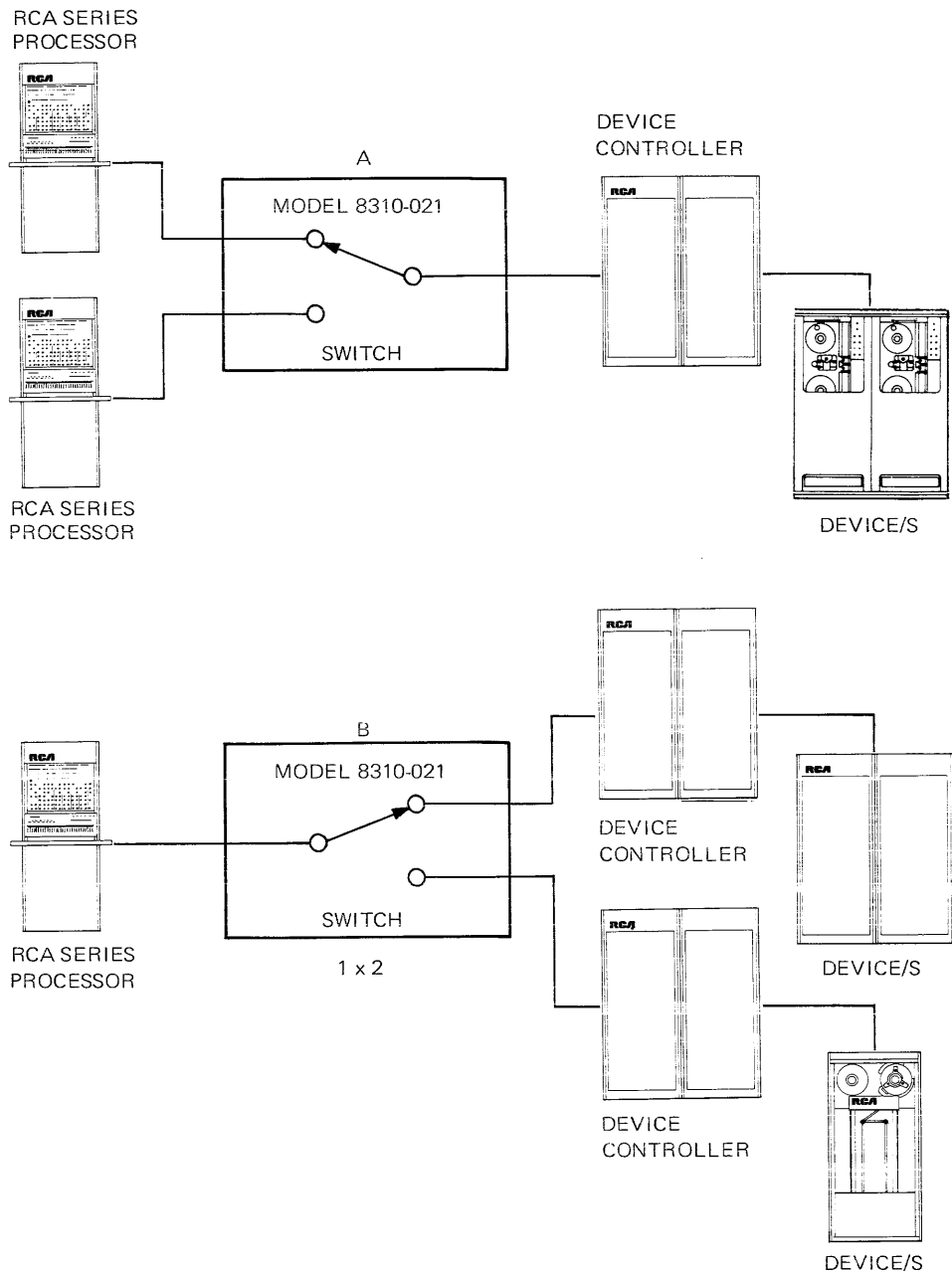

FIGURE 2-2. EXAMPLE OF MODEL 8310-021 SWITCH CONNECTIONS

TABLE 2-1 MODEL 8310 SWITCHES TO K-310 EXPANSION KITS TIE-IN

| Model* | Number of Basic 1 & 2 Switches | Applicable Switch Expansion Kit | Number of Kits Required to Expand a Switch from 1 x 2 to: | |
|----------|--------------------------------|---------------------------------|---|-------|
| | | | 1 x 3 | 1 x 4 |
| 8310-021 | 1 | K-310-1 | 1 | 2 |
| 8310-022 | 2 | K-310-2 | 1 | 2 |
| 8310-023 | 3 | K-310-3 | 1 | 2 |
| 8310-024 | 4 | K-310-4 | 1 | 2 |
| 8310-025 | 5 | K-310-5 | 1 | 2 |
| 8310-026 | 6 | K-310-6 | 1 | 2 |
| 8310-027 | 7 | K-310-7 | 1 | 2 |
| 8310-028 | 8 | K-310-8 | 1 | 2 |

*Model 8310-022 includes the Model 8310-021 switch, Model 8310-023 includes the Model 8310-021 and Model 8310-022 switches etc.

Within the cabinet, the switches may be connected (with Feature 5305) in series (cascaded) or arranged as shown in figure 2-3 to provide a 2x2 function. When switches are used, the maximum processor to device controller distance of 100 feet is reduced. One switch in the standard interface cable reduces this distance by 20 feet. Going through two switches, as shown in figure 2-3 reduces the maximum distance by 43 feet.

The RCA 8310 switch operates to either make or break a connection within 10 milliseconds. The switch can be operated at a rate of up to 10 cycles per second.

Special Features

Feature 5305 – Cascade Switch Connector – permits the interconnection of two Model 8310 switches. The number of these short cables with connectors required for a switch configuration is determined by the number of required switch-to-switch interconnections.

COMMUNICATION LINE SWITCHES

Communication line switches are available to provide switching capability (figure 2-4) for the variety of communication lines which may be used with RCA systems. Switching can be arranged to operate under manual or program control. Switching capability is provided for data gathering system lines and communication lines from the following: telegraph relays, data sets, automatic calling units, or private telephone lines. The communication switches are housed in a 24-inch x 62-inch cabinet called the Communication Line Switch Adapter (CLSA), which also houses the power supply and control unit for the switches. For program control of the communication line switches, the Model 8310 Standard Interface Switch cabinet with the Model 8350 Switch Controller is also required.

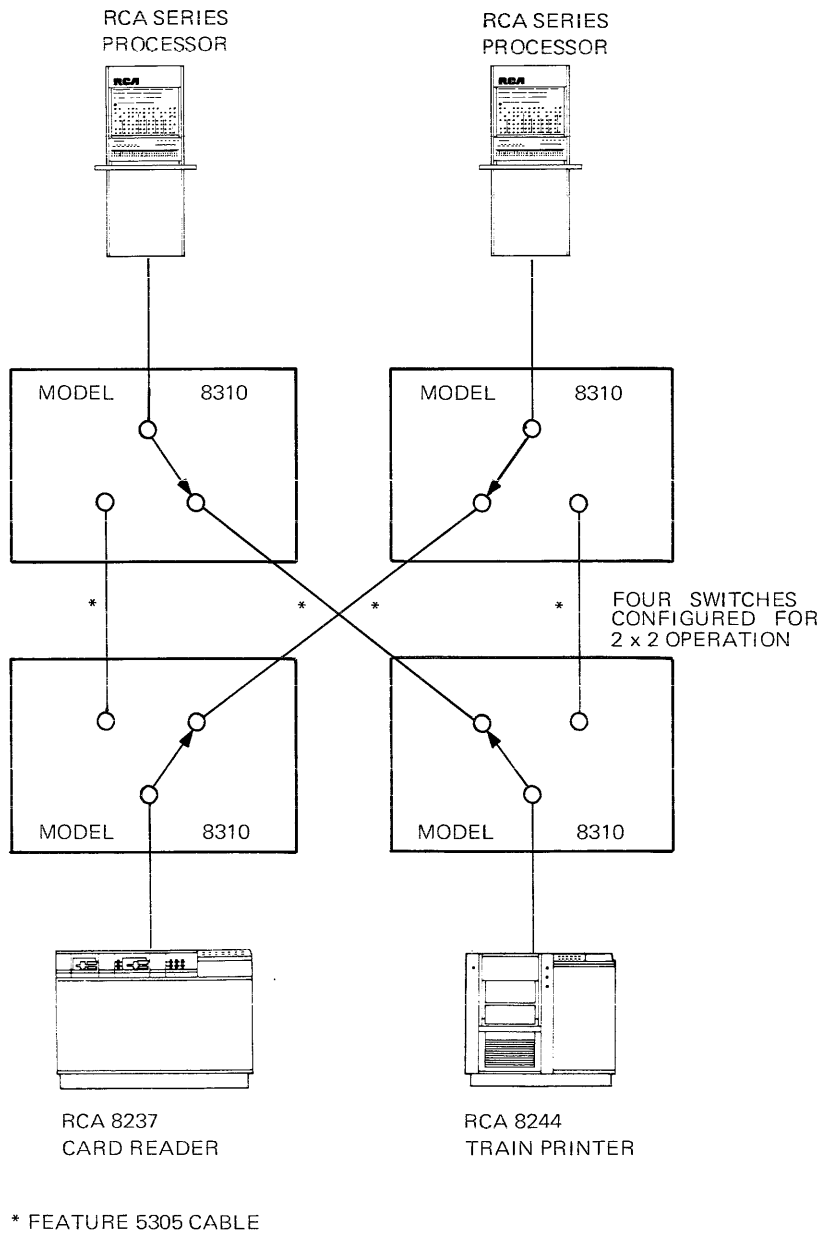

FIGURE 2-3. EXAMPLE OF TWO RCA SERIES PROCESSORS SHARING TWO PERIPHERAL DEVICES

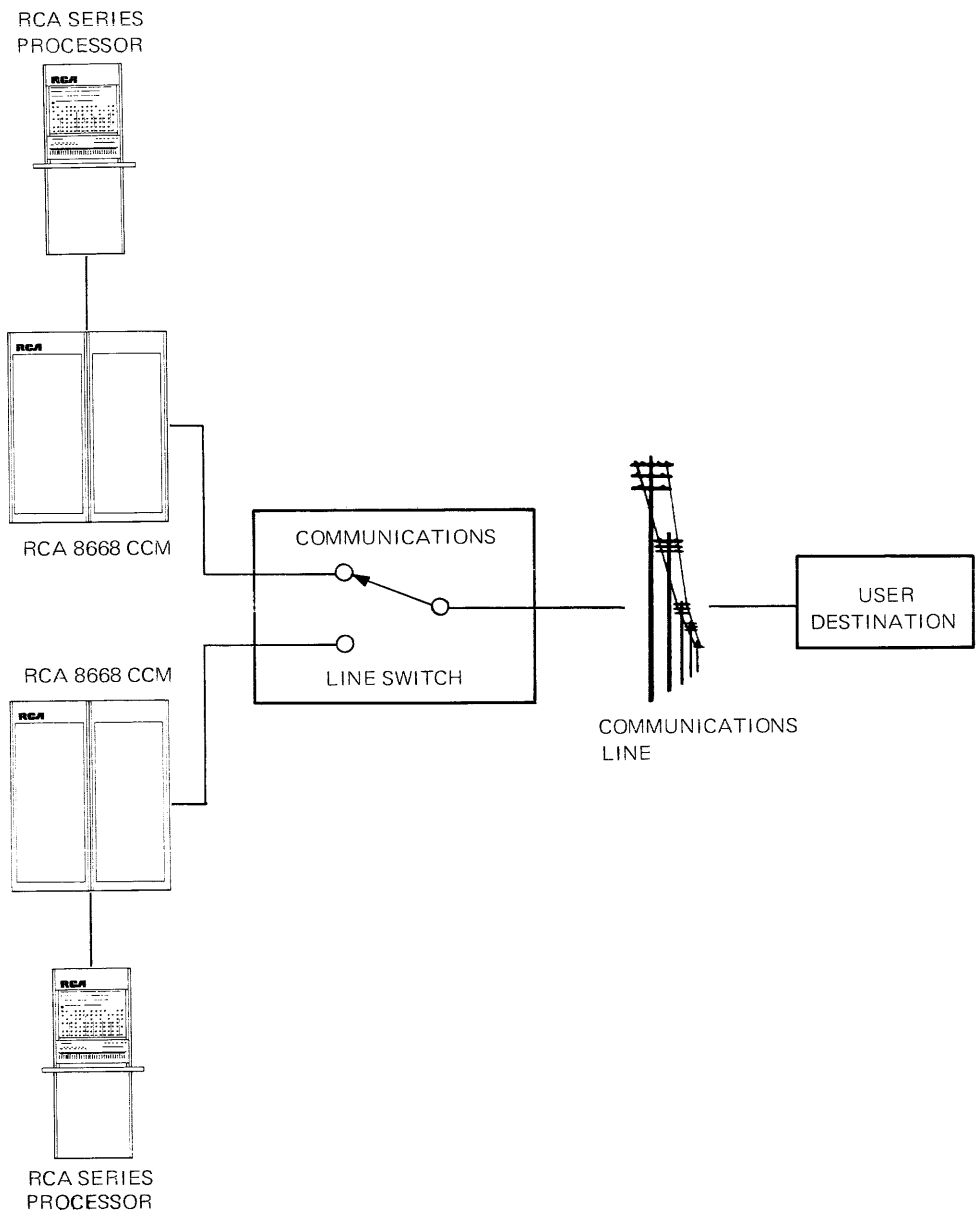

FIGURE 2-4. EXAMPLE OF COMMUNICATION LINE SWITCH

Multiple switches may be connected and controlled in parallel (ganged) as shown in figure 2-5 and connected in series (cascaded) as shown in figure 2-6. Many variations of these basic connections are available to provide for different configurations and system backup. The communication switches differ in model number according to the type of communication line they are designed to switch. The switches operate to either break or make a connection within 10 milliseconds. The switch can be switched at a rate of up to 10 cycles per second.

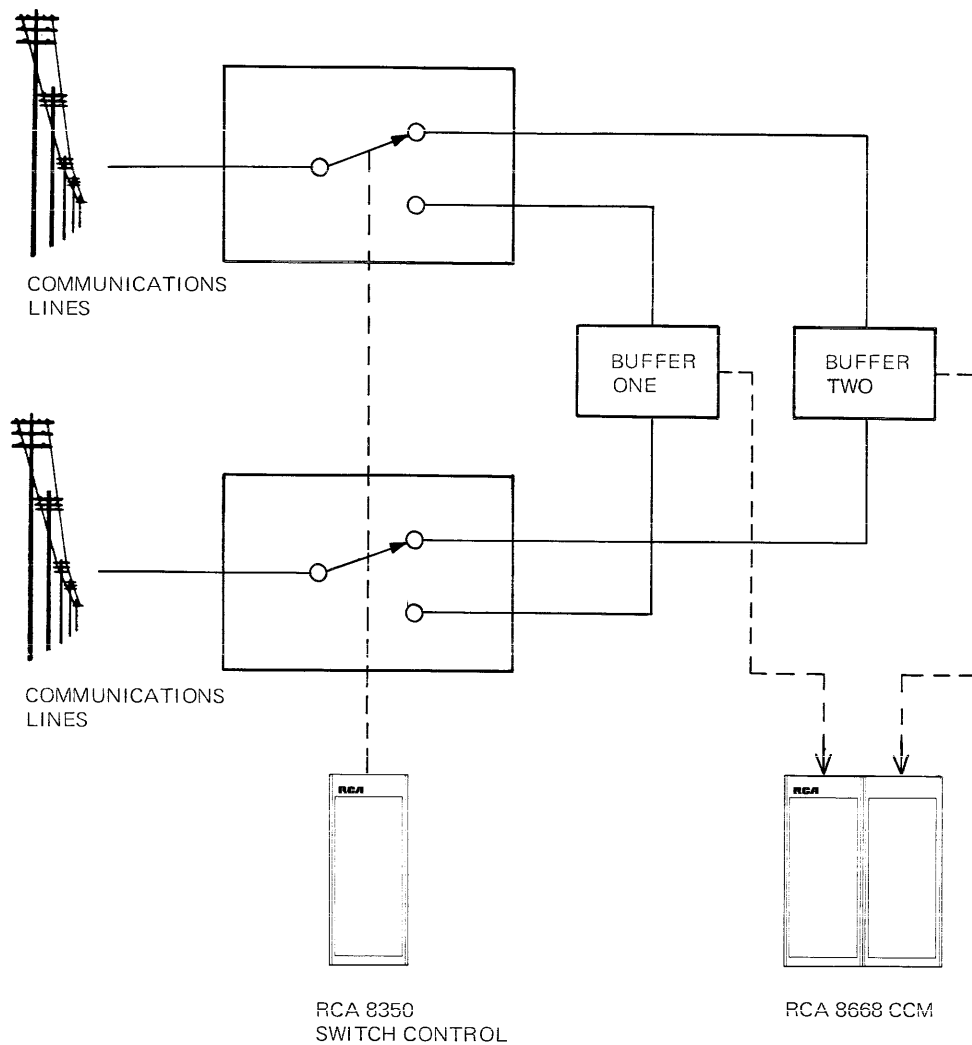

FIGURE 2-5. EXAMPLE OF TWO COMMUNICATIONS SWITCHES CONNECTED IN PARALLEL (GANGED)

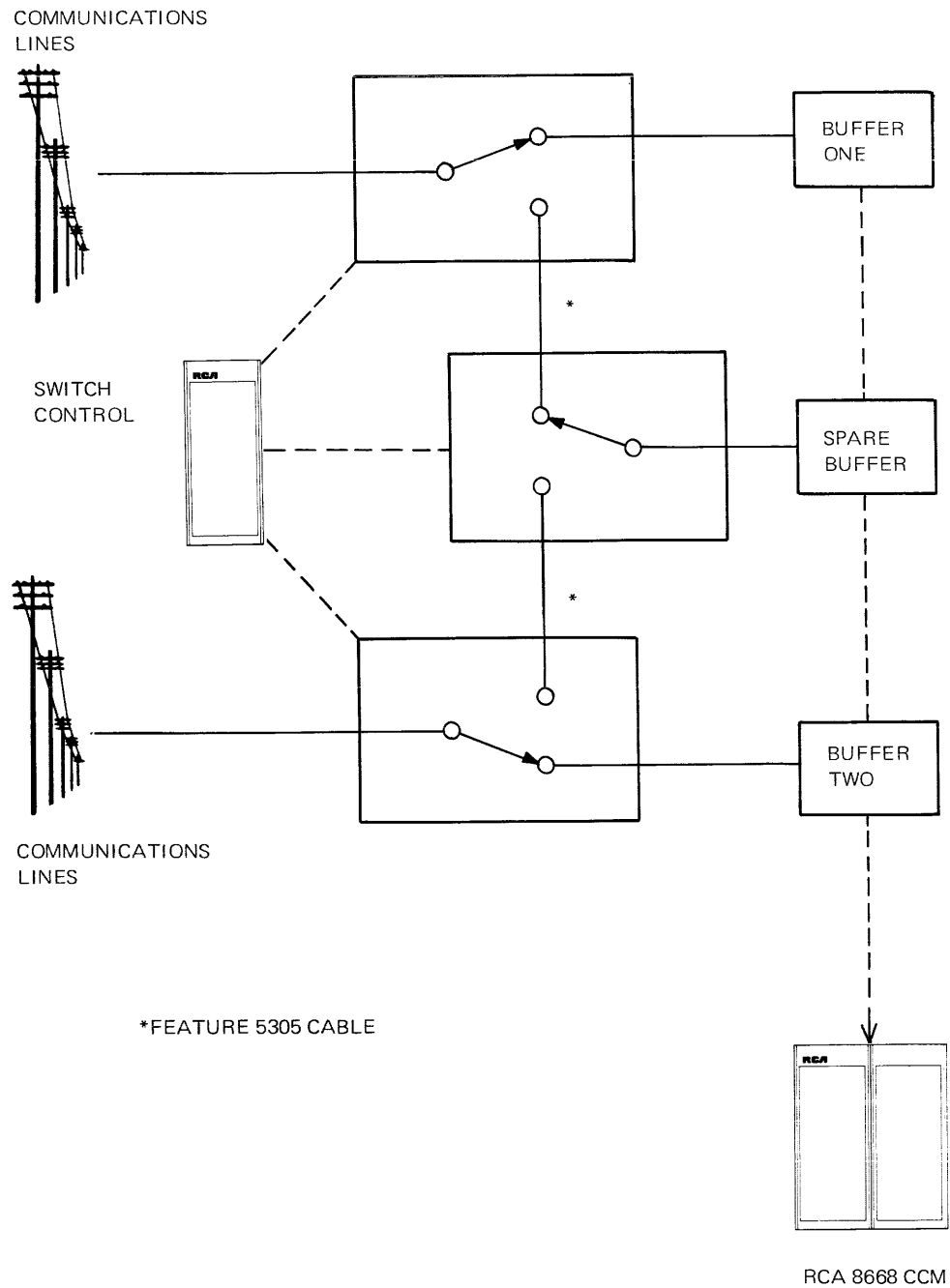

FIGURE 2-6. EXAMPLE OF THREE COMMUNICATIONS SWITCHES CONNECTED CASCADE FOR BACKUP

MODEL 8325-002 TELEGRAPH SWITCH UNIT

The RCA 8325-002 Telegraph Switch Unit (TSU) provides for switching of a set of 12 two-wire telegraph lines to either of two buffer sets as shown in figure 2-7. The Model 8325-002 TSU is housed in the Model 8356 CLSA.

Special Feature

Feature 5303 – Cable Set – provides a set of six cables which enables the Model 8325-002 TSU's to be connected in cascade as shown in figure 2-6. The TSU's may be in the same or in adjacent Model 8256 Communication Line Switch Adapter cabinets.

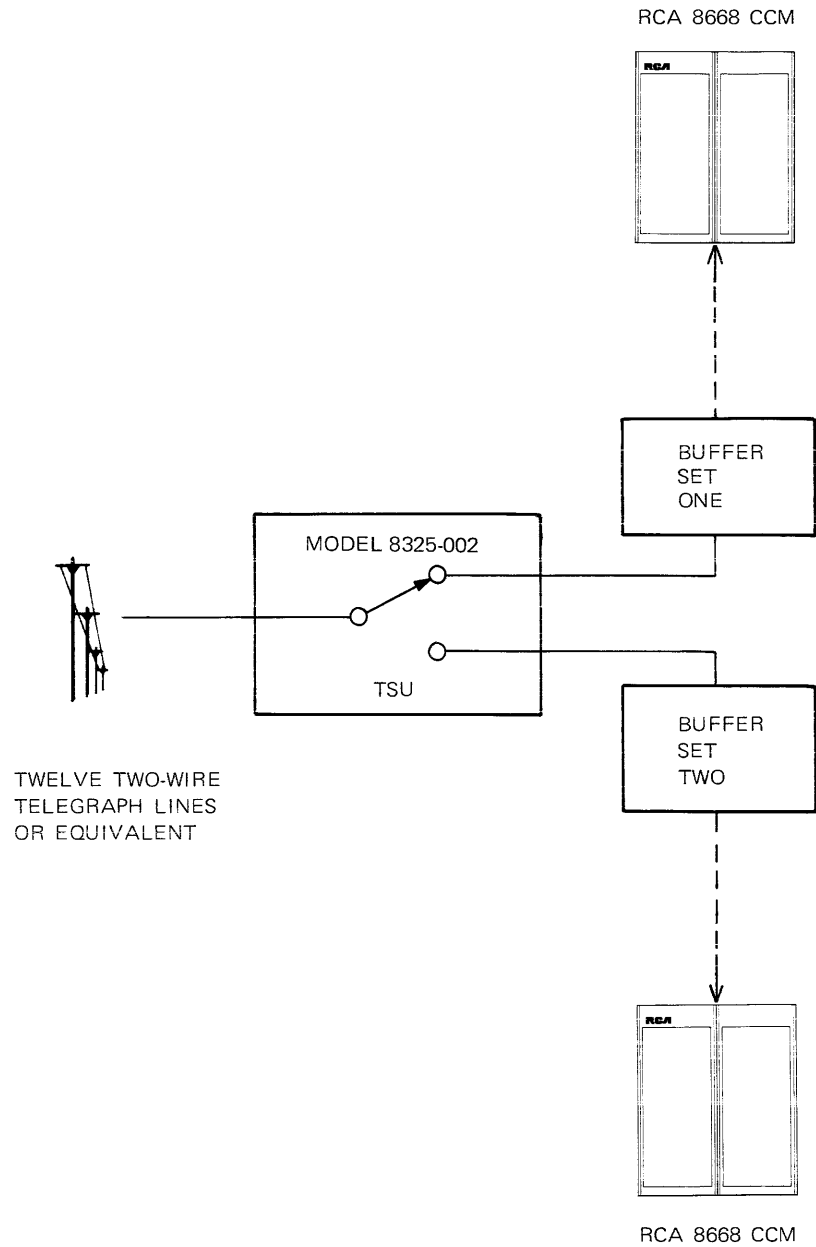

FIGURE 2-7. MODEL 8325-002 TELEGRAPH SWITCH UNIT

MODEL 8326-002 DATA SET SWITCH UNIT

The Model 8326-002 Data Set Switch Unit (DSSU) provides for switching the six 25-conductor communication lines from data sets or automatic calling units to either of two sets of buffers as shown in figure 2-8. The following buffers and/or associated automatic calling features can be accommodated: 8620, 8621, and 8622. The Model 8326-002 DSSU is housed in the Model 8356 CLSA.

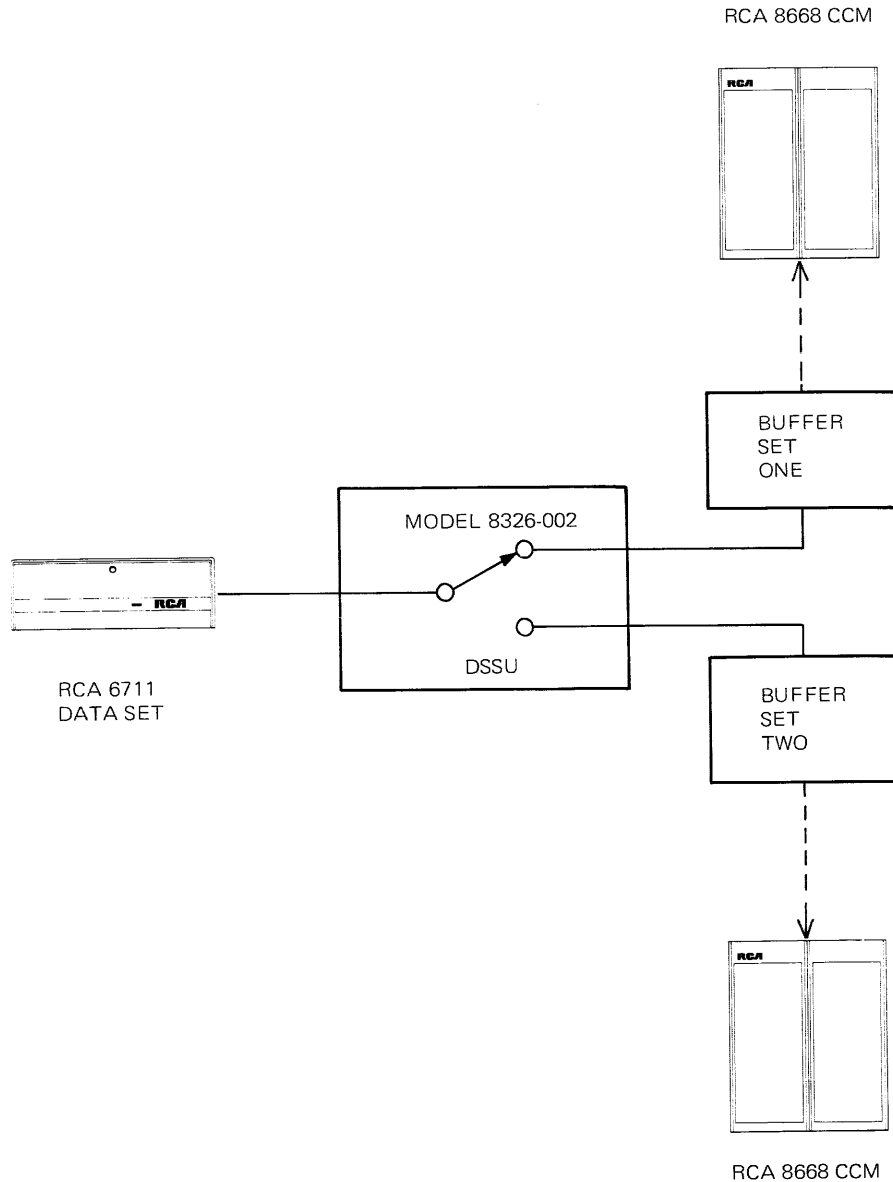

FIGURE 2-8. EXAMPLE OF 8326-002 DATA SET SWITCH UNIT

MODEL 8326-003 DATA SET SWITCH UNIT

The Model 8326-003 Data Set Switch Unit (DSSU) provides for switching of six 25-conductor data set communication lines to either of two sets of buffers as shown in figure 2-9. The Model 8326-003 DSSU is housed in the Model 8356 CLSA.

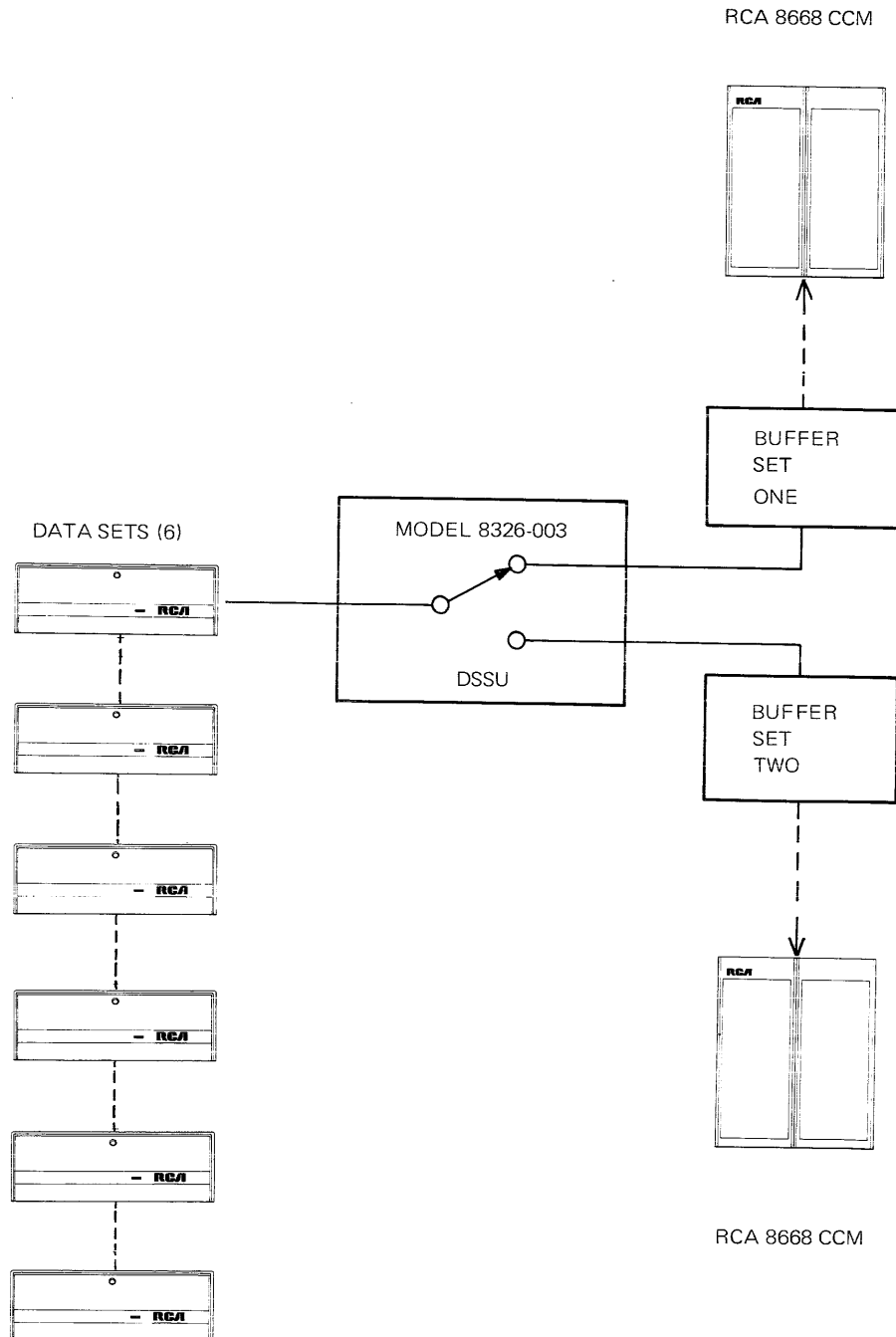

FIGURE 2-9. EXAMPLE OF 8326-003 DATA SET SWITCH UNIT

MODEL 8350 SWITCH CONTROLLER

The RCA 8350 Switch Controller provides the means for program control of up to eight standard interface and/or communication line switch units. The Model 8350 connects (figure 2-10) to the input/output channel trunk of the switch controlling processor or processors through the standard interface cable. Up to four processors (as designated by the model number suffix) can be connected to the Model 8350 but only one at a time can have control of the switching function.

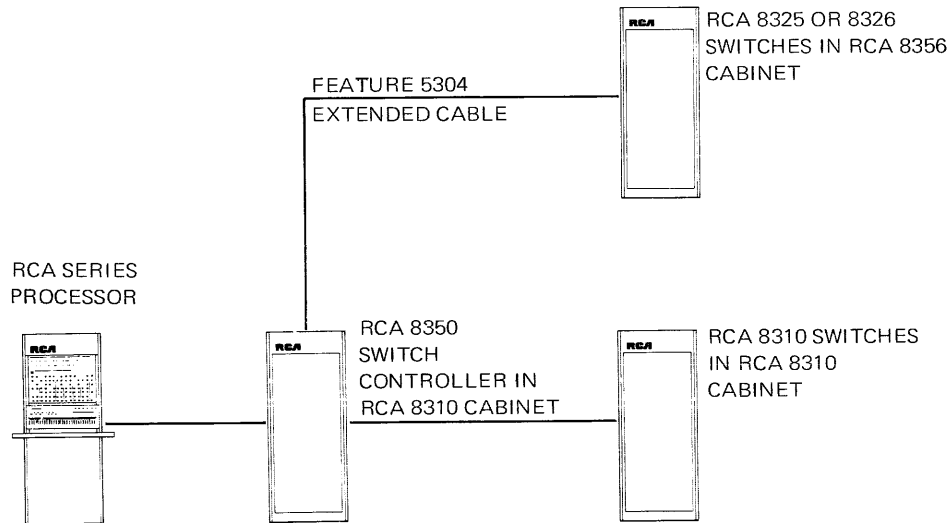

FIGURE 2-10. EXAMPLE OF 8350 SWITCH CONTROLLER

The processor communicates with the Model 8350 in the same manner as for any other peripheral device. The Model 8350 in turn controls switch position and furnishes status data to the processor. Four switch-controlling connections to the Model 8350 can be made; each connection provides control for two standard interface switches or, with Feature 5304, the full switch complement of the Model 8356 CLSA.

The following model numbers apply to the RCA 8350 Switch Controller:

- 8350-002 Provides for operation with one or two processors to control 1x2 switches in cabinet positions one through eight. By request, 1x3 and 1x4 switches may be included in this group.
- 8350-003 Provides for operation with one to three processors for control of 1x2 and for 1x3 switches (any mix), in cabinet positions one through eight. By request, 1x4 switches may be included in this group.

8350-004 Provides for operation with one to four processors for control of 1x2, 1x3 and/or 1x4 switches (any mix), in cabinet positions one through eight.

Field modification to any higher-order model suffix number is available.

Special Features

Feature 5304 – Extended Cable – provides a 50-foot cable with connectors which is required if the Model 8350 Switch Controller is to control: (1) Model 8310 Standard Interface Switches in a cabinet separate from the one containing the Model 8350, (2) Model 8325 or 8326 switches housed in the Model 8356 Communication Line Switch Adapter cabinet.

To provide remote control of Model 8310 switches, one Feature 5304 is required to supply power to the remote cabinet plus one Feature 5304 for each two switches to be controlled (for example, four switches – three Feature 5304's). To provide control of Model 8325 or 8326 Communication Line Switches in the Model 8356 cabinet, only one Feature 5304 is required to handle the maximum switch complement.

MODEL 8356 COMMUNICATION LINE SWITCH ADAPTER

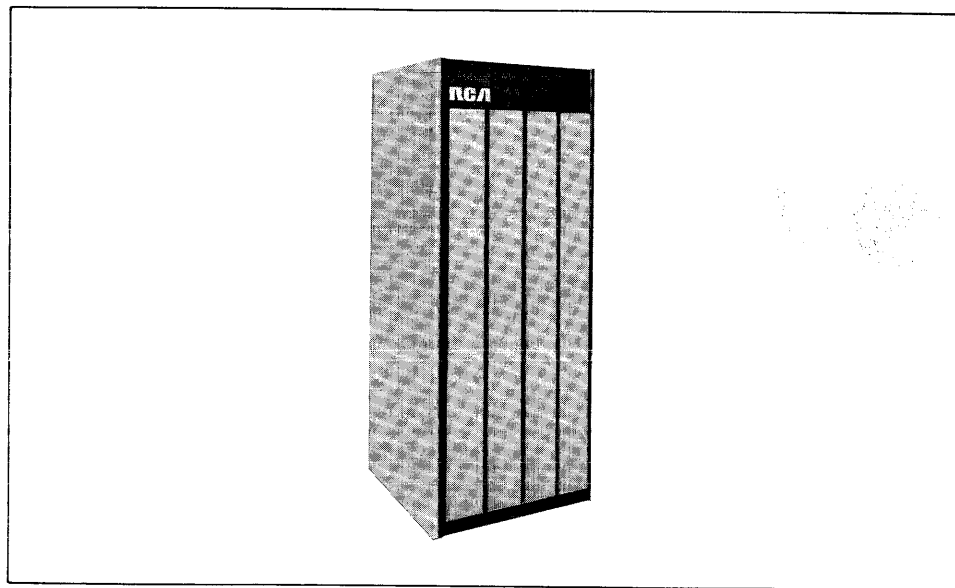

The RCA 8356 Communication Line Switch Adapter (CLSA) is a 24-inch x 62-inch cabinet which houses the switch controls, power supply, and up to 14 Model 8325 or 8326 switches. The switches are arranged in the cabinet in four groups (for example 5, 4, 3, and 2) for control by four switch controls which provide for manual switching to: one or the other of two buffer sets, off, or to remote (program control). The switches can be connected in parallel (ganged) and/or series (cascade) in the switch combination required for the particular application. If switches are to be program controlled, the Model 8310 Standard Interface Switch cabinet with the Model 8350 Switch Control and Feature 5304 (cable) are required.

Section 8: COMMUNICATION CONTROLS

GENERAL

The RCA Series Communication Controls offer a full line of devices for every application. This includes data exchange controls, single channel controllers, multichannel communication controllers, and front end processor controllers which attach to an RCA Series Processor multiplexor channel for simultaneous operation with high-speed selector channels.

The following are examples of the numerous applications in which communication controls are employed:

- Industry: (1) Update or modify central record files... (2) Query inventory status ... (3) Gain exceptions information and other vital facts needed for timely management decision.
- Banking: (1) Loan offices review of customer's credit history without time-consuming file search ... (2) Tellers look up account balances ... (3) Enter "holds" and "stop payments".
- Insurance (1) Direct access, branch to home office files, for processing policy loan value inquiries ... (2) For validation of coverage for claims payment ... (3) Policy changes and notifications.
- Military: (1) Process emergency issue orders from supply depots ... (2) Interrogate weapons systems stack for achieving optimum operational readiness.
- Utilities: (1) Answer personal and telephone customer inquiries ... (2) Enter service orders for automatic work scheduling and job ticket printing.
- State Government (1) Link Motor Vehicle branch offices to central processor and data bank ... (2) For vehicle registration ... (3) for new license applications ... (4) For file updating ... (5) For obtaining data for law enforcement and court use.

MODEL 8510 VOICE RESPONSE UNIT

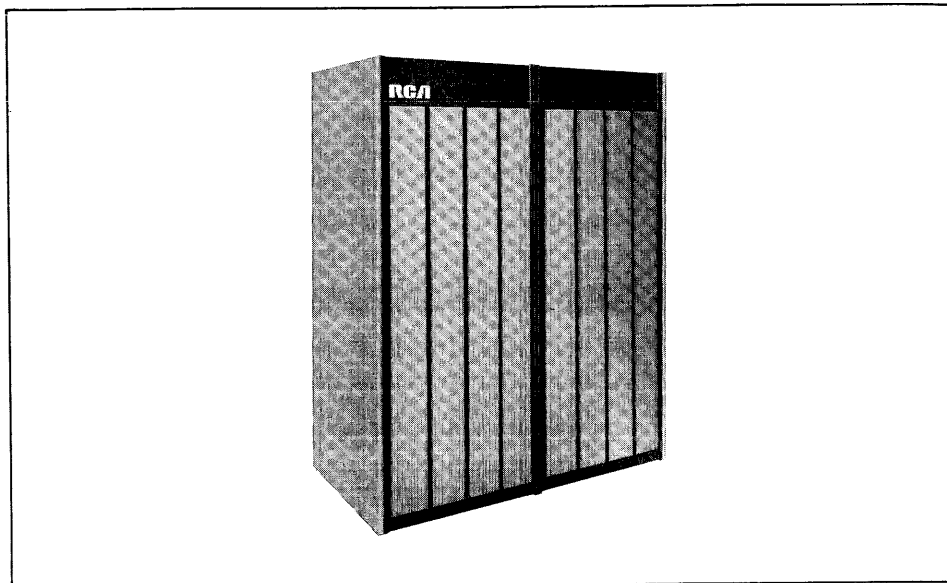

A Voice Response system (figure 2-11) is an on-line inquiry/response configuration which:

1. Accepts machine sensible input data, in the form of multifrequency tones from a remote device (such as a pushbutton telephone).
2. Processes the data.
3. Prepares the proper return data message.
4. Converts the return data message to a human-voice response.
5. Returns this voice response to the originating source.

A Voice Response System (VRS) is normally used in those applications where input data consists of short input messages and where the response can be effectively satisfied by spoken words and phrases not requiring visual display or print copy at the remote (originating) terminal. Since the response to an inquiry returns in the form of a human voice, a standard pushbutton telephone becomes the remote input/output terminal. Therefore, the existing telephone system provides the communications link to the processor. If desired, private line communications facilities may be used with Voice Response systems.

Voice Response systems can be used for such applications as checking bank balances, verification of charge account, determining inventory status, calculating telephone long distance charges, and a variety of other applications of an input/response nature.

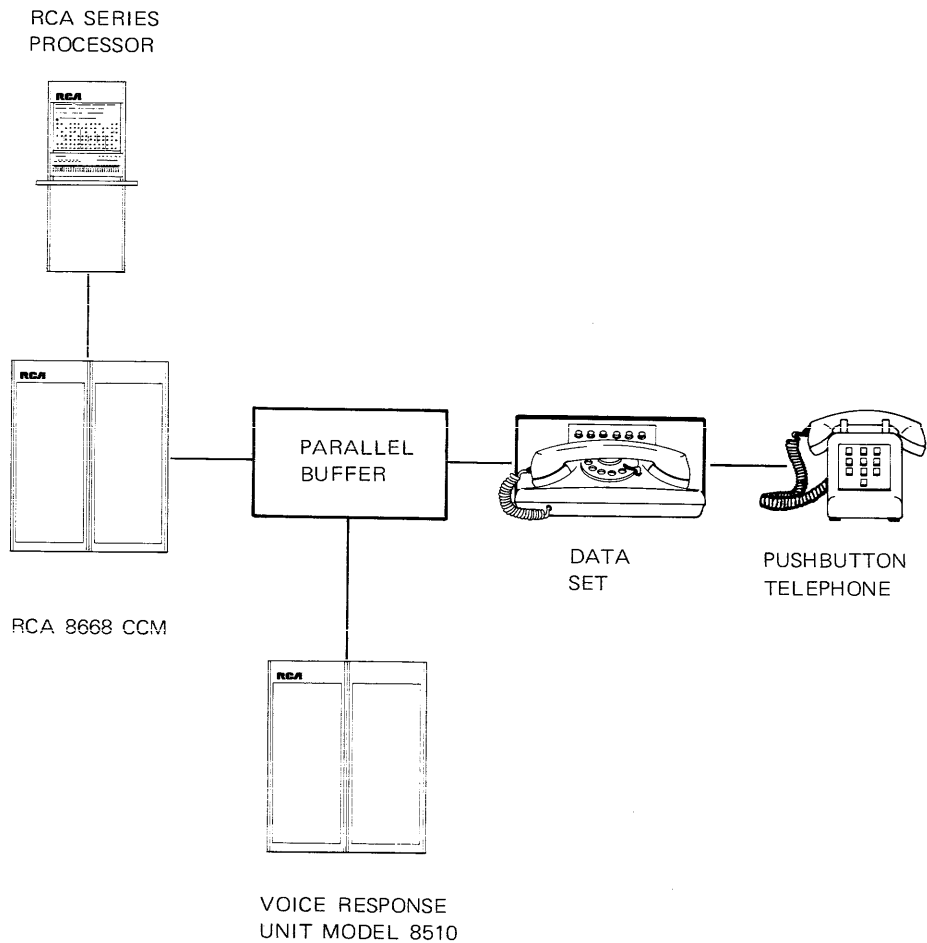

FIGURE 2-11. BASIC DIAGRAM OF VOICE RESPONSE SYSTEM

The Model 8510 Voice Response Unit provides the storage for and the means of accessing the words and phrases which make up the vocabulary of the VRU. The basic Voice Response Unit handles 10 communications lines, each terminating in a Model 8615 Parallel Buffer and an associated Bell System 403 Data Set (or equivalent). The VRU vocabulary drum has either 32 or 64 tracks. Tracks contain a film-strip recording of the selected word or phrase, one track being reserved for synchronization signals between the VRU and the parallel buffer.

The actual vocabulary is specified by the user and can be prepared in either a male or female voice. The VRU accepts track addresses from the processor in the form of digital data and sends an assembled response of selected words and/or phrases to the parallel buffer for transmission over the communications facility to the originating source.

To initiate an inquiry, the originating party places a normal telephone call to the number assigned to the VRU. A ringing signal enables the parallel buffer and associated data set to answer the call under program control. The data set returns a go-ahead tone signal to the originating party. A timer is started with this action and the caller is expected to begin entering data before the expiration of the period controlled by the timer or the call is automatically disconnected under program control.

After receiving the go-ahead tone signal, the caller transmits the inquiry, character-by-character, from the pushbutton telephone, the remote terminal.

Each character received from the data set is in the form of a multifrequency tone, consisting of two combined tones. This is referred to as a "2 of 8" code arrangement. The character is transferred to the processor's memory in that code plus the necessary additional bits to develop a nine-bit character (odd parity). The program must then translate from the line code to its internal code.

The basic VRU accommodates 10 telephone lines. A Voice Line Expansion special feature (Feature 5514) provides service for 10 additional lines.

Options permit return of a tone signal to the originator in place of a voice response and routing of incoming calls to an operator. The tone response, however, does not allow for the high degree of input verification which is provided by the voice response approach.

Voice Response systems can be arranged as either dedicated or nondedicated systems. In a dedicated system, the sole purpose of the processor is to control the VRS. In a nondedicated system, the processor has a separate information processing capability in addition to VRS control.

The following model numbers are applicable to the Model 8510 Voice Response Unit.

| <u>Model</u> | <u>Vocabulary Size</u> |
|--------------|-------------------------|
| 8510-011 | 31 words and/or phrases |
| 8510-021 | 63 words and/or phrases |
| 8510-026 | 189 words only |

Special Features

Feature 5514-11 – Voice Line Expansion – provides for 10 additional communications lines being added to the VRU. A maximum of four 5514 features may be installed in any given VRU to provide a maximum trunk capacity of 50 communications lines that can be accommodated simultaneously by a single-voice response unit.

Feature 5518-10, 20 – Custom Vocabulary – provides the custom vocabulary audio track for the VRU.

MODEL 8627 DATA EXCHANGE CONTROL

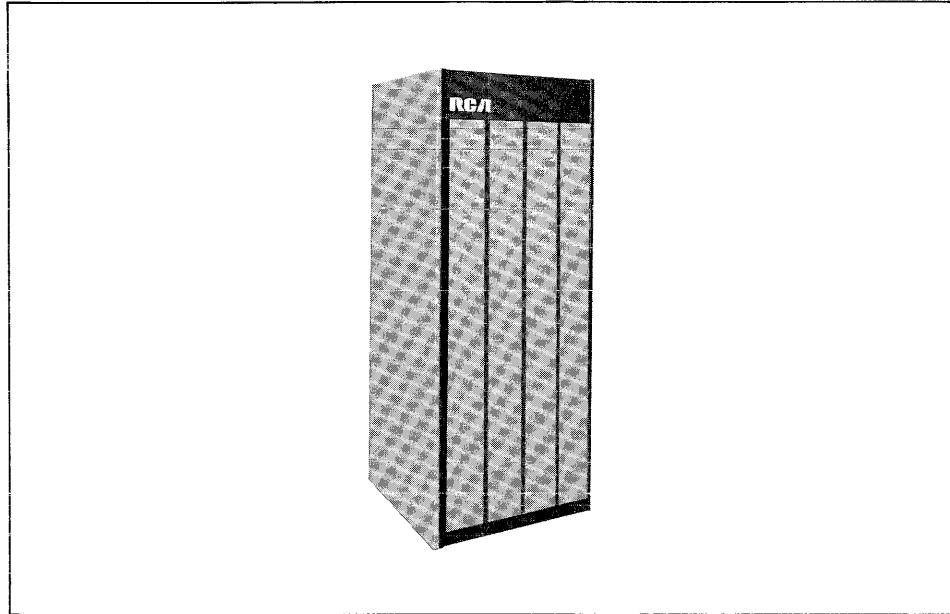

The RCA 8627 Data Exchange Control enables two RCA processors to communicate with each other. Data transmission can be in either direction, but in only one direction at a time. Either processor can initiate a transmission at any time, provided the proper program is available in each processor.

This unit provides two sets of cables, each of which connects to a processor by way of the RCA standard interface. Data is transmitted between the 8627 and a processor, one byte at a time. The average data rate depends on the type of channel used and the number of simultaneously active devices attached to the transmitting or receiving processor.

MODEL 8653 COMMUNICATION CONTROL

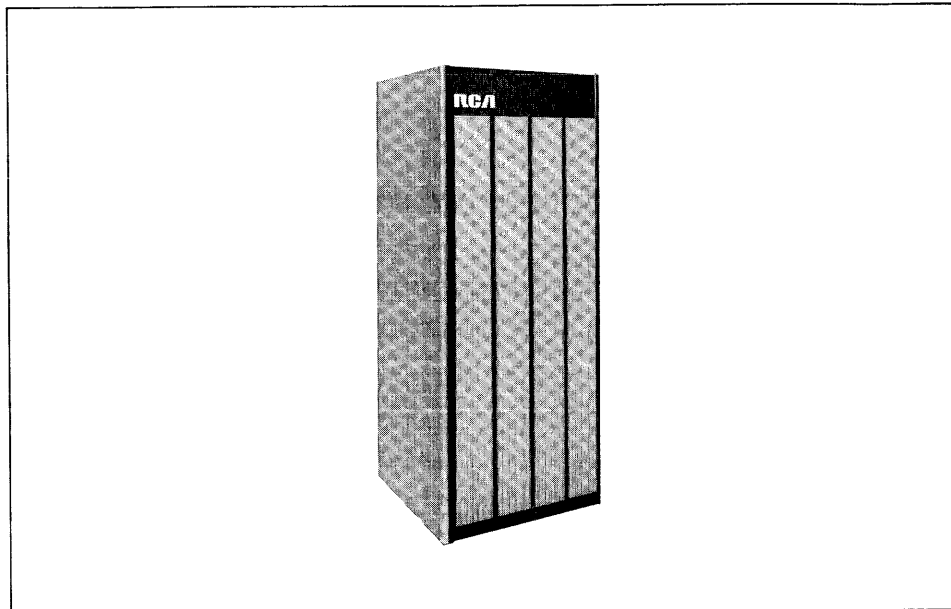

The RCA 8653 Communication Control enables the processor to transmit and receive data by way of 3kHz voice-grade communications lines or a line having a nominal bandwidth of 48kHz. This control enables data to be exchanged over long distances with an RCA Series processor, Spectra 70 processor, RCA 301 processor, or RCA 3301 processor.

When interconnected to an RCA 301 processor, the following equipment is required: a Model 376 Communication Control, or a Model 378 Communication Mode Control and a Model 6012 Communication Buffer.

When interconnected to an RCA 3301 processor the following equipment is required: a Model 3376 Communications Control, or a Model 3378 Communication Mode Control and a Model 6012 Communication Buffer.

The 8653 performs both the transmit function and the receive function, one function at a time, over a single communication line in a half-duplex operation. This control can operate with public-telephone network systems, leased-lines, or private telephone network systems. Data sets are required to interface the communications lines. Manual or automatic dialing and automatic answering techniques may be employed.

The characteristics of the various models of the 8653 are given in the following table:

| Model | Data Set | Type Line | Char/Sec (8-level) | Char/Sec (9-level) |
|----------|----------|--------------|--------------------|--------------------|
| 8653-025 | 201A3 | Manual Dial | 250 | 222 |
| 8653-025 | 201B1 | Private Line | 300 | 267 |
| 8653-026 | 201A3 | Auto Dial | 250 | 222 |
| 8653-034 | 301B | Wide Band | 5100 | 4533 |

For Models 8653-025 and 8653-026, transmission rate by way of 3kHz voice-grade communications lines is 250 or 300 characters per second for message network and private-wire facilities, respectively. The timing is supplied by the data set.

Transmission rate is 5100 characters per second for Model 8653-034 over private-leased lines having a nominal bandwidth of 48kHz. The timing is supplied by the data set.

The communication control interfaces the data set and does character framing and serialization of the data being exchanged. Channel coordination functions are performed automatically. Initiation and termination functions are effected under program control. Character and message-block parity checking is done by this control as the data is exchanged with the data set.

The transmission line code is eight bits per character (six information bits, one parity bit, and one control bit) with even parity (excluding control bit).

An installation option enables this control unit to readily exchange 9-level code.

MODEL 8656 COMMUNICATION CONTROLLER-SINGLE CHANNEL

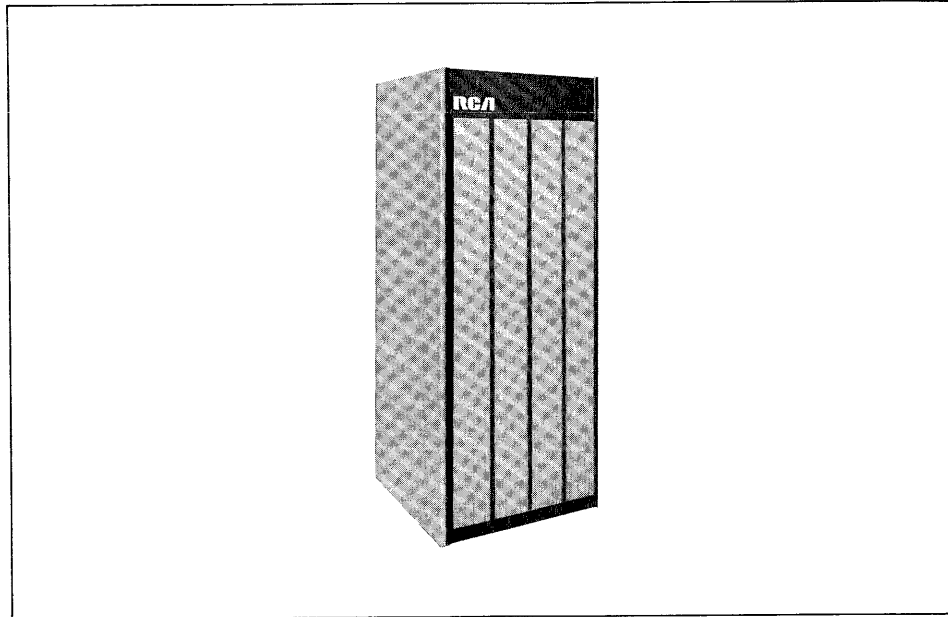

The RCA 8656 Communication Controller in conjunction with its line adapter, enables any RCA Series processor to transmit and receive data from a remote device over a communications line.

The communication control, which is connected to the processor by a multiplexor or selector channel trunk, controls transmission and reception, one function at a time, over a single communication line in half-duplex operation. The Model 8656 operates in one of three modes selectable by a manual Mode switch:

Mode 1 – Employed for simplex or half-duplex operation in which a block parity check is not required but character parity is checked.

Mode 2 – Employed for half-duplex operation when block parity and character checks are required. The remote devices using this mode of operation include: RCA Model 8668 Communication Controller - Multichannel, another RCA Model 8656 Communication Controller - Single Channel operating in Mode 2.

Mode 3 – Employed for half-duplex operation with extended capability including an optional check on intermediate block parity. The remote devices using this mode of operation include an additional RCA Model 8656 Communication Controller – Single Channel operating in Mode 3, a Model 8740 Data Terminal, an IBM 2780 Data Transmission Terminal, and an IBM 2701 Data Adapter Unit with Binary Synchronous Adapter.

One of two line adapters available as special features of the Model 8656 is required to connect the controller to the communications facility appropriate to the requirements of the remote device and systems throughput desired as shown in table 2-2.

TABLE 2-2. LINE ADAPTERS SPECIAL FEATURES

| Line Adapter | *Data Set | **Communications Facility | Speed in Characters per Second |
|---------------------------------------|-----------|---------------------------|--------------------------------|
| Synchronous HDX-1 (Feature 5630-1) | 201 A3 | DN1 (2-wire) | 250 |
| | 201 B1 | PL1 (2 or 4 wire) | 300 |
| Synchronous HDX-2 (Feature 5630-2) | 303 B5 | PL2 | 2,400 |
| | 301 B | PL3 | 5,100 |
| | 303 C5, 6 | PL4, DN2 | 6,250 |
| | 303 D6 | PL5 | 28,800 |

*These are AT&T designations (equivalent data sets of other manufacturers may be used.)

**DN1 — Dialed Voice Network.

DN2 — Dialed 50 Kilobit Network.

PL1 — Private Voice Grade Line.

PL2 — Private Channel, Type 8803 or 5705.

PL3 — Private Channel, Type 8801 or 5702.

PL4 — Private Channel, Type 8801 or 5704.

PL5 — Private Channel, Type 5754.

Special Features

Feature 5628 — Auto-Call — enables the Communication Control-Single Channel to operate with the following AT&T Automatic Calling Units: 801A1, 801A6, 801C2, or 801C4.

Feature 5630 — Synchronous HDX-1 Line Adapter — enables the 8656 to operate half-duplex with the data sets listed in the above table.

MODEL 8660 FRONT END COMMUNICATIONS PROCESSOR

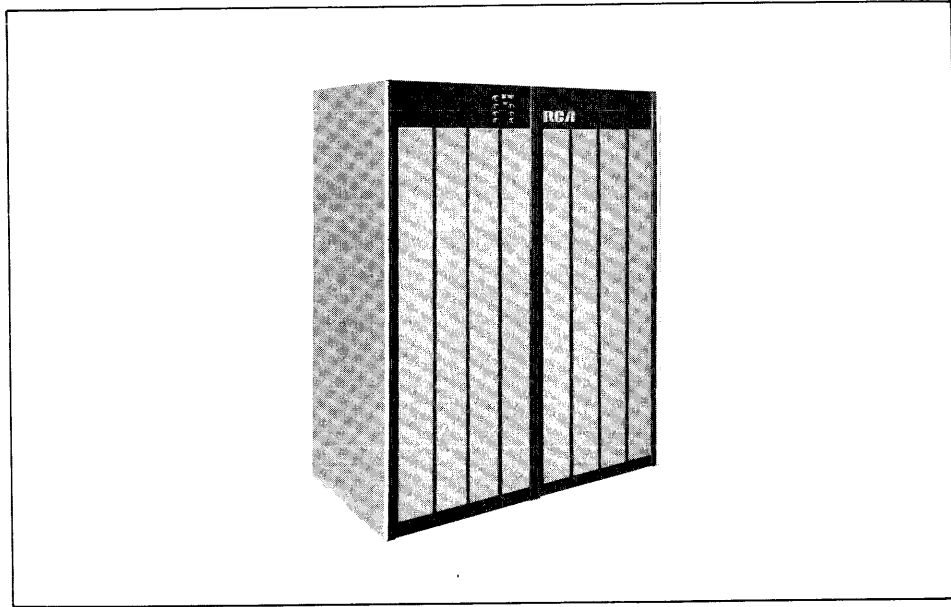

The RCA 8660 Front End Communications Processor together with the Multi-Function Communications Systems Software (MFCS) offers total communications interface capability with the following devices:

IBM 2074 Transmission Control for 360/20

IBM 1130 Processor with Communication Adapter

IBM 2780 Data Transmission Terminal

IBM 2701/2703 Transmission Control for other IBM Processors

Burroughs TC 500 Data Terminal

Subsequent releases of the MFCS will increase the capability of the RCA 8660 to interface the complete line of RCA terminals in addition to the above mentioned devices.

The RCA 8660 contains a digital, stored program, processing system. Memory sizes are 32,768 and 65,536 bytes and the cycle time for a word operation is 1.6 microseconds. There are 29 flexible instructions available for programming use.

The RCA 8660 operates in conjunction with the RCA 8656 Single Channel Communications Controller, and the RCA 8668 Multichannel Communications Controller.

MODEL 8668 COMMUNICATION CONTROLLER-MULTICHANNEL (CCM)

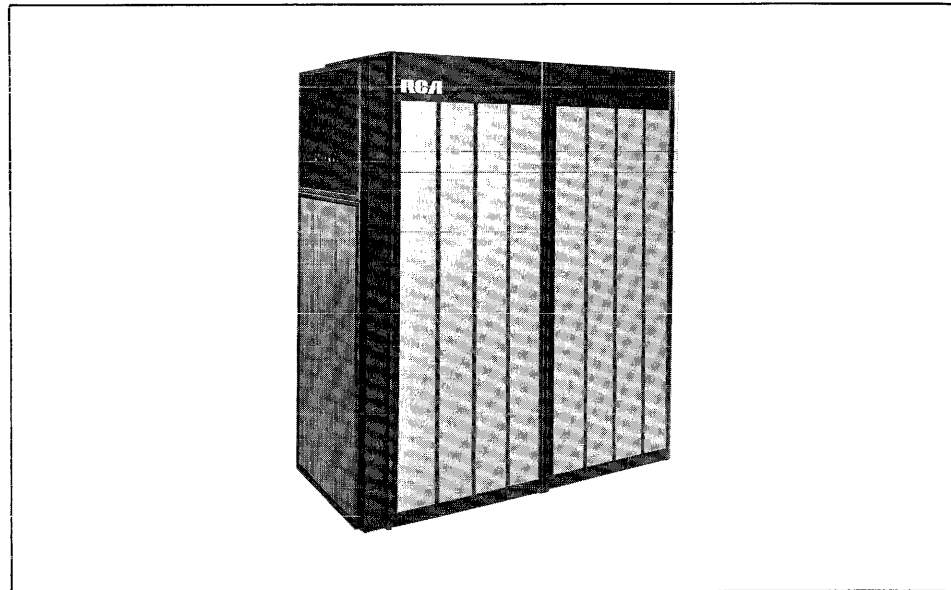

The RCA 8668 Communication Controller-Multichannel (CCM) is used with the RCA Series processors as a communications coordinating device which is capable of providing a distinct level of data and communications system control. The CCM accommodates a wide range of communications facilities and terminals via the appropriate buffers, and common carrier data sets where applicable.

There are three models of the CCM: Models 8668-011, 021, 031. Model 8668-011 provides a single-scan sequence for a maximum of 16 communication lines. Models 8668-021 and 8668-031 provide a dual scan (selectable at installation) sequence for 32 and 48 lines respectively, thereby servicing the first 16 high-speed lines more frequently than the remainder.

Each CCM is connected to the processor through a single multiplexor trunk. The actual number of CCM's used with any one processor is governed by the available main memory, the number of multiplexor channel trunks, the number of communications lines serviced, and the data rates of the communications lines. Considering these factors, it is possible for a processor to simultaneously control and service a maximum of 240 low-speed communications lines. One CCM can service a mixture of buffers with a maximum data rate of 6000 bytes per second and can control up to 16 different types of communications facilities and remote terminal devices.

The CCM services each communication line through an interface with a single buffer which is designated by a specific device address, except for full-duplex terminations which require two separate buffers and device addresses.

A core memory within the CCM provides basic communications system status information and operating rules, as well as one character storage for data being transferred between the processor and the buffers. This memory consists of 512 eighteen-bit words, including parity. It has a read-regenerate, clear-write cycle time of two microseconds.

The entire CCM memory is initialized by the program upon start of operations, after General Reset, if a program generated change is desired.

A primary function of the CCM is to notify the processor of the recognition of specific characters and character sequences having a control significance for a particular communications system. As determined by the systems classification section of the CCM memory, the CCM checks each character for correct parity, block parity, or constant ratio code. The CCM also detects and takes action upon indications that remote communications devices have failed to maintain a prescribed transmission rate.

All data transferred between the CCM and buffer is bit serial. The assembly of incoming bits and serializing of outgoing characters, including character framing, are performed by the CCM. Stored parameters, set by the CCM program, specify the code structure used on a particular communication line. All character codes are transferred to and from the processor in eight-bit bytes, plus correct parity. Codes consisting of fewer than nine bits are identified by systems classification and modified for acceptance by the processor. Transmission of data from the processor is handled in a corresponding manner by the CCM before the data is presented to the appropriate buffer.

Special Features

Feature 5617-1 – Telex – modifies any model CCM to permit half-duplex asynchronous operation of the Western Union Telex service on-line to an RCA Series processor, by way of the 8610 buffer.

Feature 5618 – ANSCII Block Check Character – modifies any model CCM to handle the block check character in accordance with the proposed standard as defined by the American National Standard Code for Information Interchange (ANSSCII).

Feature 5620 – Timer Restart/Interval Selector – modifies the Data Timeout function of any model CCM to provide a more flexible timing operation. It consists of a change in the resetting and restarting of the timer, and includes a means of selecting one of three timing intervals (24-second, 10-second, or 2-second) at the time of installation).

Feature 5622 – Message Separation – modifies any model CCM to permit the effective separation of a series of messages received in a single, continuous transmission by alternating two CCM operations under control of specific classifications.

Feature 5623 – OW-Unshift – provides any model CCM that can handle Baudot telegraph systems, or other systems with shift control, with the capability of using a control character (usually space) to perform the same unshift function as the letters character.

Feature 5624 – Timer Reset – modifies the data timeout function of any CCM to permit the input of long sequences of throw-away characters without generating a CCM timeout.

Feature 5635 – Synchronous Full-Duplex Operation – provides CCM protection against extended out-of-sync (character frame) conditions during full-duplex operations involving long series of messages transmitted in a continuous sequence. Each message is separated from the one following by a positively recognizable bit pattern which permits synchronization to be reestablished if lost.

Feature 5645 – IBM BSC, ANSCII Basic Mode – provides the capability to interface with IBM processors which use the BSC, ANSCII non-transparent mode communications technique.

Note: Special Feature 5617-1 is applicable to Models 8668-011, 021, 031. Special Features 5618, 5620, 5622, 5623, 5624 and 5635 are applicable to Models 668-011, 021.

Section 9: COMMUNICATIONS BUFFERS

GENERAL

The communications buffers described in this section are the physical interface between the Model 8668 Communications Controller-Multichannel (CCM) and the data set or communications line. The communications buffers are housed in the CCM. (See figure 2-12.) The buffers provide storage area and allow the timing of the communications line or data set to be adapted to the CCM timing.

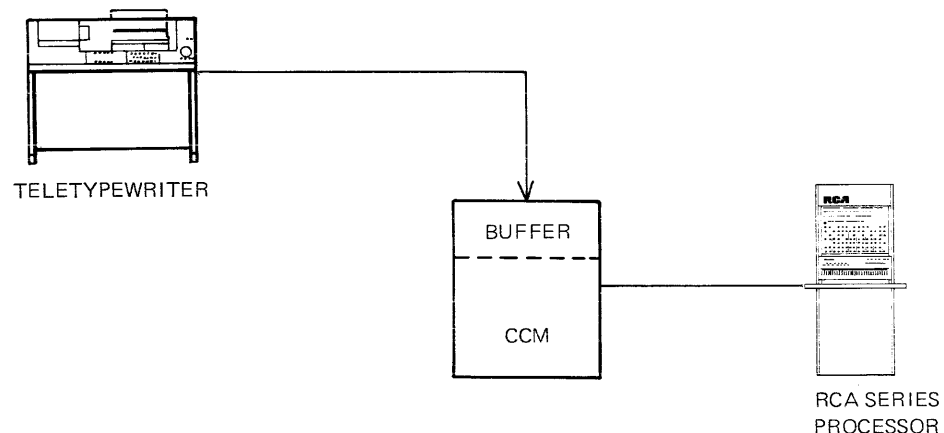

FIGURE 2-12. EXAMPLE OF A TELEGRAPH BUFFER

MODEL 8610 TELEGRAPH BUFFER

The RCA 8610 Telegraph Buffer operates asynchronously with both private line telegraph circuits leased from a common carrier, or equivalent customer-provided facilities. Buffer operation is half-duplex, with each buffer occupying one scan position of the CCM. Two telegraph buffers are required for full-duplex operation. The telegraph buffer operates with the following remote devices:

Model 28 Teletypewriter equipment.

Model 32, 33, and 35 Teletypewriter equipment.

(RCA Models 6740, 6741, and 6742 are comparable to Teletype's Model 35.)

Applications involving the use of Models 32, 33, and 35. Teletypewriters are subject to RCA Policy definitions. The telegraph buffer operates with the following common carrier teletypewriter systems: Bell System (83B2 and 83B3) and TELEX.

The buffer normally operates with all the above devices at transmission speeds of 6, 7.5, or 10 characters per second.

MODEL 8612 TELEGRAPH LOW LEVEL BUFFER

The RCA 8612 Telegraph Low-Level Buffer occupies one scan position on the CCM, and enables the CCM to exchange control and bit-serial data signal with remote devices using low-level dc signaling.

The 8612 Buffer is functionally identical to the 8610 Telegraph Buffer except that the 8612 Buffer is designed for low-level signaling, Maximum operating current required is 0.1 milliamperes. Existing line programs and hardware check routines for the 8610 Buffer may be used in similar applications for the 8612.

The Model 8612 consists of three blocks that must occupy three adjacent block positions in a CCM plug-in row. The buffer cannot be switched by the Communications Line Switch Adapter. Two buffers are required for full-duplex operation, but no special feature is required.

MODEL 8615 TELEGRAPH PARALLEL BUFFER

The RCA 8615 Parallel Buffer provides the interface to a Bell System (or equivalent) 403 Series Data Set. It accepts bit-parallel data from the data set and transfers it to the CCM. The 8615 outputs word and/or phrase track addresses from the CCM to an associated Voice Response Unit (for example, Model 8510), where it is converted to audible signals and returned to the 8615 for transfer to the communications line and the Touch-Tone® type of telephone device which originated the data input.

MODEL 8617 PARALLEL DATA SET BUFFER

The RCA 8617 Parallel Data Set Buffer enables the CCM to receive data from a Bell System Dataspeed Type 5 Tape Sender (5A or 5C) or from equivalent devices. The 8617 interfaces the AT&T 402D Data Set and the Tape Sender interfaces the AT&T 402C Data Set. The maximum data transfer rate is 75 characters per second. Timing signals are supplied by the data set.

Characteristics

Received data may be 5-, 6-, 7-, or 8-level code. Discrete calling may be used to prevent an unauthorized call from obtaining data from an unattended tape sender.

Reverse channel signaling may be used as a break or circuit assurance feature. Automatic answer of incoming calls may be accomplished at either the CCM or tape sender.

Called party control, for unattended stations, whereby the sender will disconnect the line if transmission does not begin within 30 seconds after an incoming call is answered.

May be used on the direct distance dialing or private line networks.

To permit command chaining to separate multiple messages included in a continuous data transfer the 8668 CCM must be equipped with Feature 5622.

Special Feature

Feature 5717 – Auto-Call – enables the 8617, under control of the processor and 8668 CCM, to automatically dial a communications line. Feature 5717 requires two additional block positions adjacent to the buffer.

MODEL 8620 ASYNCHRONOUS DATA SET BUFFER

The RCA 8620 Asynchronous Data Set Buffer operates with telephone (voice-grade) and subvoice grade circuits at modulation rates up to 2400 bits per second. It can be used with either private line or message network facilities furnished by a common carrier. Buffer operation is half-duplex with each buffer occupying one scan position of the CCM. Two 8620's are required for full-duplex operation. This buffer operates asynchronously using start-stop framing elements.

The Model 8620 Interfaces the RCA 6711 Data Set, the 203 or 202 Series Data Sets of the Bell System or equivalent data sets of other manufacturers, and operates with the following remote devices and systems:

| | |
|-------------|--|
| RCA | Video Data Terminal Model 8752-100, 8752-200 Video Data Interrogator Model 6077 Data Terminal Model 8762 |
| Bell System | Data Speed Type 2 TWX 8A1 private line selective calling equipment Teletypewriters (33, 35 and 37) on Data-Phone Service® Teletypewriters (33, 35 and 37) on 150-baud or voice-grade private line circuits |
| IBM | 1050 Data Communication System 2741 Data Communication System |

Several options are available depending upon user requirements. These options can be installed in the field and provide for two-wire, four-wire, and reverse channel operation.

Four models of the RCA 8620 are provided as follows:

| <u>Model</u> | <u>Service</u> |
|--------------|---|
| 8620-011 | TWX (Teletypewriter Exchange-4 row) with interface to Customer Provided Terminal (CPT). |

- 8620-021 Message network and private line services with data sets or equivalents.
- 8620-022 Same as 8621-021 except with reverse-channel capability.
- 8620-023 Used with Asynchronous terminals such as the IBM 2741, AT&T 33, 35, or 37 Teletypewriters on private line services using AT&T 108 or 103F Data Sets. This buffer recognizes BREAK signals from terminals on referenced data sets.

Special Feature

Feature 5705 – Auto-Call – enables the buffer to operate with an AT&T Automatic Calling Unit to provide, under program control, automatic dial and connect operation.

Feature 5714-1 – Full-Duplex Operation – modifies a pair of 8620 Buffers so that they can be used for full-duplex operation on leased lines with the appropriate data set.

MODEL 8621 SYNCHRONOUS DATA SET BUFFER

The RCA 8621 Synchronous Data Set Buffer operates with telephone (voice-grade) circuits at modulation rates of up to 4800 bits per second. Timing is supplied by the data set. It can be used with either private line or message network facilities furnished by a common carrier when interfaced with the appropriate data set. Buffer operation is half-duplex with each buffer occupying one scan position of the CCM. Two 8621 Buffers and a special feature are required for full-duplex operation.

The RCA 8621 interfaces the 201A and 201B Data Sets of the Bell System or the equivalent data sets of other manufacturers. The 201A3 Data Set is used with applications involving the message network. The RCA 8621 can communicate with the following remote devices:

- RCA
 - Communication Buffer - Model 6012
 - Communication Control - Models 376 and 3376
 - Communication Control - Model 8653
 - Communication Control - Model 8656
 - Modular Video Data System Controller - Model 8759-021
 - Data Terminal - Model 8740
 - Video Data Terminal - Model 8752-200
 - Data Terminal - Model 8762

- UNIVAC
 - DCT 2000

Special Features

Feature 5705 – Auto-Call – enables the buffer to operate with an AT&T Automatic Calling Unit to provide, under program control, automatic dial operation.

Feature 5714 – Full-Duplex Operation – modifies a pair of 8621 Buffers so that they can be used for full-duplex operation on leased lines with the appropriate data set.

MODEL 8680 TIME GENERATOR/BUFFER

The Model 8680 Time Generator/Buffer is a single integral unit consisting of an electronic clock and a buffer which transfers the time-of-day records bit-serially to the CCM, and to a control panel. Each time-record transferred to the CCM consists of four, 9-bit, odd-parity characters with each character representing one of the digits 0 through 9 in the EBCDIC code. These digits are automatically generated and transferred to the CCM whenever a time change occurs in the least significant digit, provided that a Receive command is present. The 8680 is automatically reset to zero hours (00.00) when the maximum time count (23.98) is reached. The 8680 occupies one scan position of the CCM.

The internal clock of the 8680 also can be synchronized with a master time system by connecting a three-wire cable containing a minute, an hour, and a return line.

Section 10: TERMINALS AND ASSOCIATED DEVICES

GENERAL

The RCA Series supports conventional terminals and sophisticated equipment by providing a pool of special-purpose terminals and devices.

This includes remote data terminals, remote card readers, fully-buffered video terminals, data couplers (which permit RCA data terminals to be used on the IBM 360 and 370 systems), data sets, and a full line of teletypewriters that includes a universal power supply that supplies dc voltage where it is necessary.

MODULAR VIDEO DATA SYSTEM

The Modular Video Data System (MVDS) consists of the RCA 8751 Video Data Terminal, the RCA 8756 Video Data Generator, and the RCA 8759 Video Data Controller. The MVDS can be connected directly to a trunk of the multiplexor channel of an RCA Series processor for local operation, or through the RCA 8668 Communication Controller-Multichannel (CCM) for remote operation. The 8759 Video Data Controller connects between the processor, or CCM, and the Model 8756 Video Data Generators which are housed in the Model 8759 cabinet. The Model 8756 Video Data Generators provide the memory, character generators, and logic to operate the Model 8751 Video Data Terminals which provide the interface with the operator.

MODEL 8751 VIDEO DATA TERMINAL

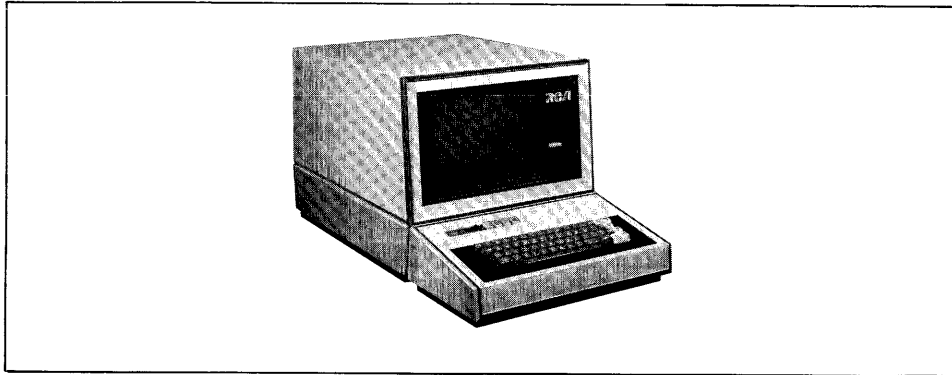

The RCA 8751 Video Data Terminal contains a 12-inch rectangular cathode ray tube that can hold from 270 to 1080 characters depending upon the Video Data Generator to which the Video Data Terminal (VDT) is connected. A set of 96 characters, formed from solid lines is generated by a monoscope and is displayed depending upon the ANSCI characters entered from the keyboard or transmitted from the processor. The character set transmitted to the processor depends upon the choice of keyboard. Models 8751-010 and 8751-011 VDT's provide a 70-character keyboard set. The Model 8751-010 is arranged in typewriter layout. The 8751-011 can provide either typewriter or an alphanumeric keypunch layout (selectable), but without the capability of generating lower-case letters. The Model 8751-012 VDT provides a 96-character keyboard with a typewriter-style layout including lower-case letter capabilities.

Message composition by the operator is facilitated by a full complement of cursor (character position underscore) controls and also screen, line, and character-erase controls plus data insertion. By using the Message Segment Address function, an incoming message may be displayed starting at the cursor position instead of the beginning of the screen.

Special Features

Feature 5728 – Cable Set – furnishes the cables required for the interconnection of each Video Data Terminal to its associated Video Data Generator. Maximum cable length is 500 feet.

Feature 5770-2 – Connector Kit – provides all the necessary connectors in the event that the customer wishes to provide his own cable sets.

MODEL 8756 VIDEO DATA GENERATOR

The RCA 8756 Video Data Generator (VDG) provides character storage and control for the Video Data Terminals (VDT's) connected to it. At installation time, all VDT's connected to a VDG are wired to accommodate the selected display array options offered for the particular model of VDG. The VDG's are contained in the Model 8759 Video Data Controller cabinet. Table 2-3 shows VDG models verses number of VDT's and VDT character array.

TABLE 2-3. VIDEO DATA GENERATOR CHARACTERISTICS

| VDG Model | Maximum Number of VDT's | Character Array* | Characters Per VDT |
|-----------|-------------------------|--|--------------------|
| 8756-011 | 8 | 10 lines — 27 characters/line or 5 lines — 54 characters/line | 270 270 |
| 8756-021 | 4 | 20 lines — 27 characters/line or 10 lines — 54 characters/line or 6 lines — 80 characters/line | 540 540 480 |
| 8756-031 | 2 | 12 lines — 80 characters/line or 20 lines — 54 characters/line | 960 1080 |

*A variety of character arrays, including those shown above, can be selected by making appropriate jumper connections on the printed circuit boards involved. Line lengths may be varied within the following range: 27-32, 49-64 and 80 or 81 characters per line. Consistent with the screen capacity and line length selected, the number of lines displayed may be selected from the following: 5, 6, 9, 10, 12, 13, 14, 17, 18, 20, 22, 25, 26, and 29.

Special Features

Feature 5716 – Data Format – enables the VDG to record each character of designated groups of characters received from the processor in a distinctive code which then prevents the cursor from stopping under that character position. Characters thus recorded represent format headings which assist the VDT operator in entering variable information. Format headings are not included in transmissions to the processor.

Feature 5721 – Variable Start of Transmission – provides for operator control over the point at which transmission commences by the manual insertion of Start of Text (STX) at any location on the screen.

MODEL 8759 VIDEO DATA CONTROLLER

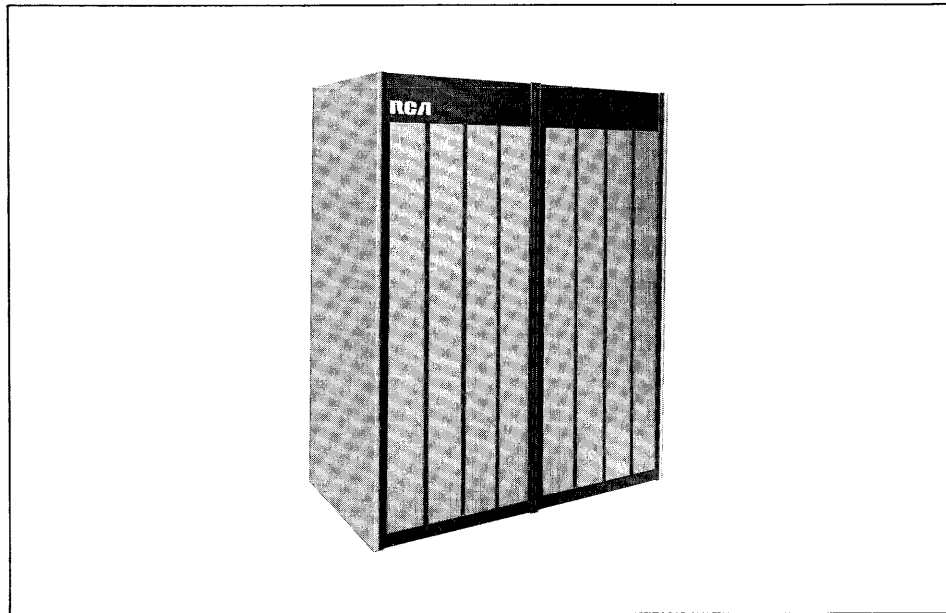

The RCA 8759 Video Data Controller (VDC) operates directly with the multiplexor channel of a processor over a communications line by way of the Model 8668 CCM and Model 8621 Buffers.

The Model 8759-011 operates directly on the multiplexor channel of the processor at a rate up to 2400 bytes-per-second in each direction (4800 bytes-per-second total). Housing up to six VDG's, the VDC can handle up to 48 VDT's.

The Model 8759-021 operates through a communications link at rates up to 2400 bits per second (4800 bits-per-second full-duplex). Housing up to 4 VDG's, the VDC can handle up to 32 VDT's.

The communications link consists of an AT&T 201B Data Set, or equivalent, a four-wire, voice-grade, communications channel AT&T4B (conditioned), and another 201B Data Set or equivalent. The latter data set is connected to two Model 8601 Synchronous Data Set (SDS) Buffers with Special Feature 5714 housed within the Model 8668 CCM which operates on a multiplexor trunk of the processor.

Special Features

Feature 5717 – Station Selector – enables up to six Model 8759-021 Video Data Controllers to be used on a multistation communications line, where administration of the line control (polling) is performed by the processor.

STAND-ALONE VIDEO DATA TERMINALS

The Stand-Alone Video Data Terminals are the RCA 8752-100 and RCA 8752-200. Generally, these terminals connect to the RCA 8668 CCM through a communications buffer. An RCA 8755-100 Video Data Switch or RCA 8755-200 Data Terminal Switch provides a means of connecting up to eight (8755-100) or 16 (8755-200) Video Data Terminals to the same communications line.

All Stand-Alone Video Data Terminals are manually controlled, completely self-contained, desk-top, input/output display devices which permit communications between an operator and the processor. Inquiries and transactions may be composed on the unit keyboard, verified on the display screen and, if necessary, corrected before transmission. The processor response may be displayed as long as the information is useful. In all cases the control over the mode of operation remains with the Video Data Terminal (VDT) operator.

MODEL 8752-100 VIDEO DATA TERMINAL

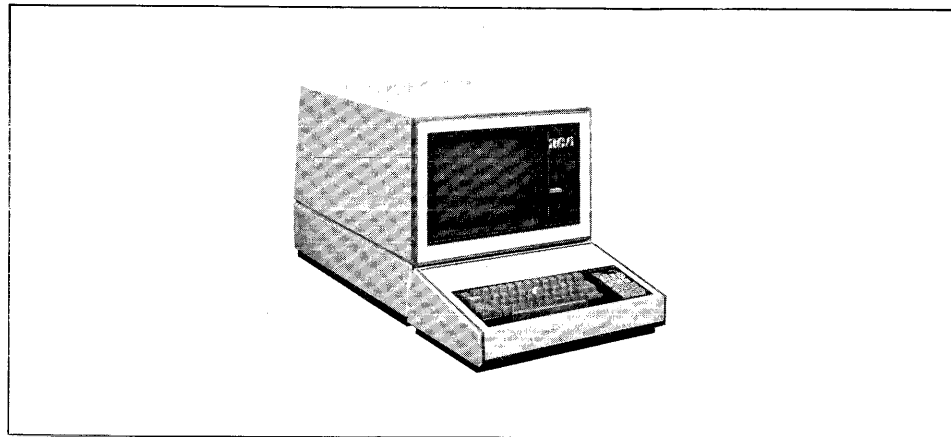

The RCA 8752-100 Video-Data Terminal includes a four-row keyboard, a display memory for storage of locally generated data, data received over the communications line, and cursor control information. It also includes the circuitry required for read, write, and erase operations. Other control modules such as a character generator, the input/output logic, and data set interface are also contained in the viewer.

The display itself is a 12-inch rectangular cathode ray tube which can simultaneously display a maximum of 1080 characters, in 20 lines of 54 characters per line. A maximum of 64 code combinations can be displayed. (The ANSCII code is used with this device.) Certain nondisplayable codes can be generated by the keyboard, but are displayed as blanks on the video tube. A moving cursor (underscore) gives a continuous indication of the position of the next character to be displayed. All characters are checked for even parity as they are read from the display memory to the viewer. A parity error is displayed as a brightened area on the viewer in the position of the character in error.

All data and control characters are generated through the keyboard, except the Start of Text (STX) character which is generated automatically when transmission begins. Twelve special-function keys and indicators for all other control operations are grouped to the right of the standard keyboard.

The VDT can be interconnected with the processor by way of the CCM and the 8620 Buffer. Data transfer to and from the VDT is by way of private line telephone circuits or the telephone message network. The applications require the use of Bell System 202C or 202D Data Sets or their equivalent. Optionally, the 8752-100 may be directly connected to the 8620 Buffer (without data sets) up to 50 feet from the processor. The line code contains 10 bits per character (seven ANSCII data bits, one parity bit (even), one start, and one stop framing element). Transmission is asynchronous at 1200 bits (120 characters) per second with the lowest-order bit being transmitted first.

The normal sequence of operation begins with the composition of the data message by the operator. When complete, the message may be verified and edited, if necessary. When the operator is satisfied with the information, a switch is pressed which transmits the displayed data from the VDT memory to the communications line. The VDT is then automatically placed in the receive mode.

Since the display remains on the screen until the message is answered or erased, the operator can reactivate the write mode and retransmit the data if no response is received within a reasonable period.

Under normal operation, data messages that are returned from the processor overwrite the previous image and the receipt of the end transmission character erases the balance of the previous display. If the Message Segment Address (MSA) switch is activated, the response will begin at the cursor position.

A message segment address control also allows only a portion of the display to be transmitted. This capability is controlled by the operator positioning the cursor to the first character of the segment which will be transmitted.

A data insert switch is included which, when activated, causes all characters at and to the right of the cursor position to be shifted one position to the right with each new character entry. All displayable characters are shifted to the next line with the exception of RETURN and End of Text (ETX). Control codes and nondisplayable characters are not shifted through to the next line. When this switch light is placed in the OFF position, normal VDT operation is restored. The data insert function is not provided for VDT's using the Data Format Special Feature 5710.

Special Features

Feature 5707 – Station Selection – permits up to 26 VDT's to share a common private line telephone circuit and to be polled sequentially by the processor to invite transmission from each remote VDT. The actual number of VDT's installed in this manner is dictated by the traffic volumes and operational requirements of the particular application.

Feature 5710 – Data Format – provides a means of recording information received from the processor in a distinctive code configuration which alters the normal cursor operation. Characters thus recorded represent format headings which assist the operator in composition of complex messages or identify the various data fields when a record is retrieved from the processor. This feature is very useful for originating the variable data applicable to repetitive transactions. Transmission from the VDT thus involves only the variable data entered by the operator or returned by the processor.

Feature 5711 – Printer Adapter – allows data stored in the display memory to be printed out to an associated Model 33, 35 or 37 Teletype page printer. This data may originate from the processor, the VDT keyboard, or both. Printing is accomplished at a speed of 10 cps.

Feature 5713 – Keyboard Cable Extension – allows the VDT keyboard to be physically separated from the viewer by distances of 5, 10, and 20 feet.

Feature 5725 – Data Set Cable Extension – provides the necessary cable extension to install the 8752-100 up to 100 feet.

Feature 5733-02 – Special Symbol Set (Spanish) – modifies the display symbols and key tape by changing the ÷ (divide) symbol to ¿ (inverted question mark) and the & (ampersand) to ñ. No change in the codes generated by the keys involved nor any functions result from this special feature.

Feature 5734-01 – Special Character Array – provides for variations in the character array in which data is displayed on the viewer. This feature is installed by plug-in board replacement. An installation option permits the selection of either an 80- or 81-character line.

MODEL 8752-200 VIDEO DATA TERMINAL

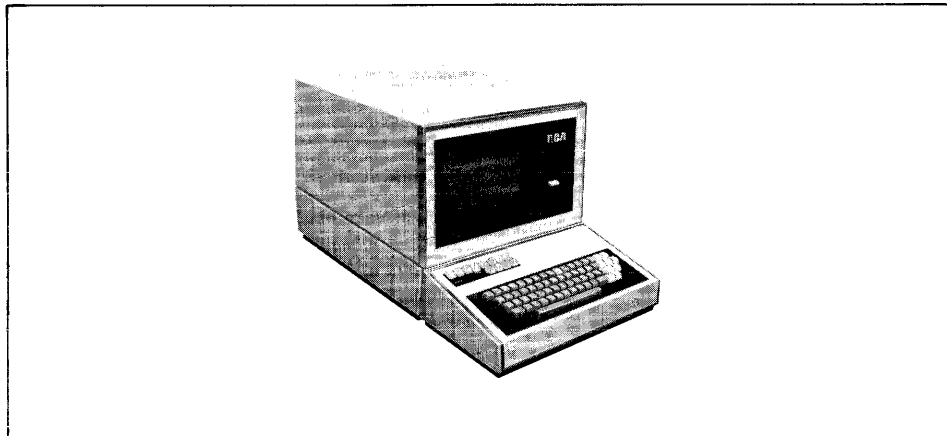

The RCA 8752-200 Video Data Terminal is available with one of three optional keyboards and a monoscope display of 1080 or 1134 characters. The 8752-200 offers synchronous or asynchronous operation at from 300 to 2400 bits per second, and can be operated on the same (full-duplex) line with the Modular Video Data System. A full editing capability is available including: seven cursor movement controls, data insert, delete (erase and

close up); four manual and two processor-controlled erase function. Processor independent checkout and automatic retransmit capabilities minimize the need to run maintenance routines on the processor. A processor override switch allows incoming messages to force the terminal mode from write to receive. A broadcast option allows RCA 8752-200 terminals on a single communications line to be arranged into any number of subgroups for common message reception. The RCA 8752-200 Video Data Terminal is available in the following models:

8752-210 – Upper case ANSCII characters including alphanumeric and special characters (70 characters in total).

8752-211 – Same as -210, but with right hand numeric (keypunch) keys, and a shift control (NUM) key.

8752-212 – Full upper- and lower-case ANSCII characters (96 characters in total).

The available no-cost options are as follows:

Local Operation – Permits direct connection to the 8620 Buffer in the CCM; operation must be asynchronous at 1200, 1800, or 2400 bps.

Space Symbol Suppress – Suppress ANSCII SPACE symbol (·) from display only (switch option).

Carriage Return Symbol Suppress – A switch suppresses display of the ANSCII CR symbol (<<).

Message Identification (MID) – Provides hardware generation of MID character, which is included in all messages transmitted from the 8752-200. MID is mandatory when the Printer Adapter Feature is installed.

Screen Arrays – 20 x 54 (1080 characters) or 14 x 81 (1134 characters).

Broadcast Option allows simultaneous message transmission to all, or to any subset, of the 8752-200 Video Data Terminals on a multipoint circuit with Station Selection Feature.

Processor Override switch allows an incoming message to force the 8752-200 into the receive mode.

Special Features

Feature 5713-5-10-15-20 – Keyboard Cable Extension – allows the keyboard of any 8752-200 to be located up to 20 feet from the display unit.

Feature 5760 – Station Selection – permits a Video Data Terminal to be used on a multistation communications line in an efficient manner by providing the control (polling) and discrete terminal addressing capability. Satisfactory operation of the Video Data Terminal on a multistation line can be assured only by the use of four-wire communications circuits. The number of 8752-200 Terminals that can be connected on a single multistation line is limited in practice by the characteristics of the communications facilities, rather than the characteristics of the Station Selection Feature.

Special Feature 5761 – Data Format – allows formats (field or item identifiers, headings, etc.) and other constant information to be called up from the processor, and displayed in lower intensity characters which cannot be changed from the keyboard, and which can be retained when keyboard entries are erased. TAB and SKIP keys are effective when this feature is installed.

Feature 5762-1 – Printer Adapter – operates a printer at up to 120 characters per second from additional memory, freeing display memory for other operations. This can be controlled by the operator, by the processor, or automatically (for unattended operation on leased lines only).

Feature 5764 – Display Suppress – conceals a keyboard entry of confidential information such as file access codes etc. A switch with light is provided on the keyboard to control the display suppress function. At the time of installation, the number of characters (from one to fifteen) in the suppressed field is selected. When the switch controlling this function is pressed, the selected number of characters is blanked from the display starting at the location of the cursor but the contents of display memory are not altered. Characters typed into these locations are neither displayed nor copied but are transmitted normally when the SEND key is operated. Transmission starts with the first character of the suppressed field without regard to other transmit start controls. Receipt of a message other than a Retransmit command or Processor Override message erases the blanked characters and resets the suppression logic. A second operation of the Display Suppress switch will also perform the erase and reset functions. This feature enhances the auto-transmit operation.

Feature 5765 – Screen Address – allows messages from the processor to be displayed at any point on the screen and can handle any number of locations, in any order. It also provides for processor control of cursor location. This feature also provides a “retransmit” function, which allows the processor to send a control code to any 8752-200 to cause a retransmission of the last message sent from that VDT. This action would be taken whenever the processor finds a parity error indicator in a message from a VDT.

Feature 5766-5-25-50-100 – Data Set Cable – required with each 8752-200 and must be specified at the time of order. No charge for 5, 25, or 50 foot lengths. The 100 foot length is used only between the 8752-200 and the 8755-200 Data Terminal Switch.

Feature 5767 – Break/Availability – provides for the use of the supervisory channel of asynchronous data sets to enhance the exchange of control and status information between the VDT and the processor. This feature requires that the data sets have the reverse channel feature implemented and that the 8620-022 buffer be used. It can be used only on point-to-point asynchronous communications lines.

Feature 5771 – Double Page – provides access to two 1080 (or 1134) character segments of memory, one of which is displayed. The operator can interchange or combine the two pages. This feature precludes the installation of the Array Expansion Feature. The double page feature alters the normal function of the printer adapter feature, screen address feature, and processor override option.

Feature 5772 – Display Expansion – uses full memory capacity for displaying either 1620 or 1782 characters. Feature 5772 provides a range of arrays from 30x54 to the maximum capacity 22x81 array. This feature precludes installation of the Double Page Feature, and precludes buffered print operation under the Printer Adapter Feature.

Feature 5774 – Local Operation Cable Extension – provides a cable complete with connectors to extend distance to more than 50 feet between the VDT and the processor. (The cable on the buffer is 50 feet). When this feature is used, the Local Operation option is not to be exercised as the cable takes care of this. This is a made-to-order cable, the length of which in feet is defined by the dash number after the feature number. Maximum length is 200 feet. This feature is used only when the Video Data Terminal and the CCM/Buffer are connected to the same building ground.

MODEL 8755-100 VIDEO DATA SWITCH

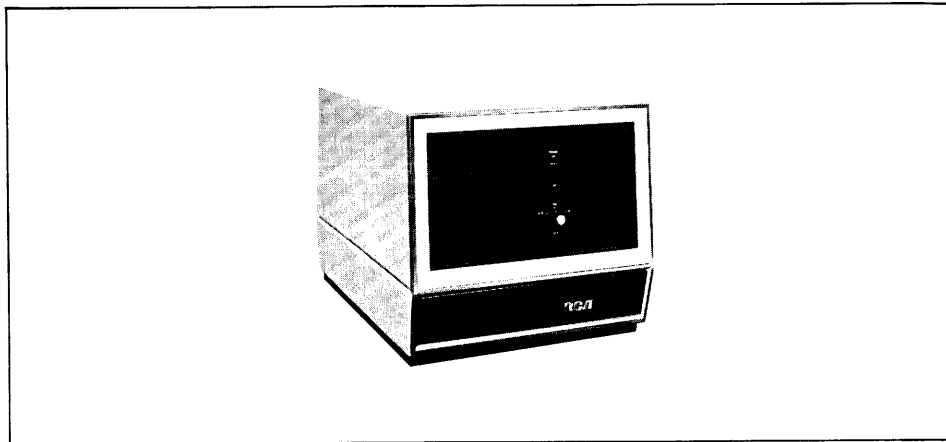

The RCA 8755-100 Video Data Switch permits a maximum of eight RCA 8752-100 Video Data Terminals to be connected to a single communications line or directly connected to an RCA 8620 Buffer channel. Connection of the RCA 8755-100 to a communications line is made through an asynchronous data set (Bell System 202C, D, or equivalent) or directly to the processor channel through an RCA 8620 Buffer. Connection for local operation through the RCA 8620 Buffer and CCM is an installation option. A cable for connection to the data set and connectors to accommodate cabling from up to eight 8752-100 Video Data Terminals is provided with the RCA 8755-100.

MODEL 8755-200 DATA TERMINAL SWITCH

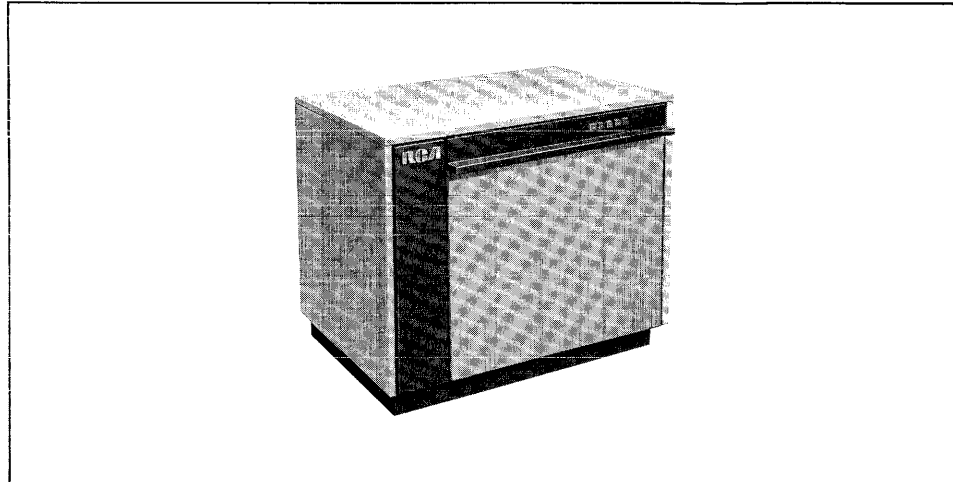

The RCA 8755-200 Data Terminal Switch, permits the operation of up to eight 8752-200 Video Data Terminals or 8762 Data Terminals, in any combination, over a single voice-grade communication facility using a single data set.

The RCA 8755-200 may be expanded to accommodate up to 16 terminals transmitting through either one or two communication lines, with the capability of selecting either line in case of failure.

A Print Control feature allows connection of up to two printers to a switch, to be shared by the connected Video Data Terminals.

The connected terminals operate in their normal polled (multipointed, station-selected) mode and the switch is transparent to the terminals and their supporting software.

The RCA 8755-200 provides for synchronous or asynchronous modes of operation, various speeds provided with the data terminals, and local connection to the processor without data sets.

The RCA 8755-200 is fully compatible with the Spectra 70/7522 Video Data Terminal. This means that the 8755-200 Data Terminal Switch can be used directly on Spectra 70 Systems which use 70/7522 Video Data Terminals.

Special Features

Feature 5801 – Data Terminal Switch Expansion – permits connection of up to an additional eight terminals to the Data Terminal Switch (DTS). All options must be the same for the basic unit and expansion unit terminals. With this feature, the 1X/2X line option may be exercised.

Feature 5766 – Data Set Cable – provides the cables needed for connection to the Data Terminal Switch. This feature for the 8752-200 must be ordered with the terminals. Distances desired are designated with a hyphen and length following the basic feature number.

Feature 5775 – Print Control – permits a single hard copy device to be sequentially employed by up to eight VDT's associated with the DTS. A second Feature 5775 Print Control may be added to permit the connection of another printer. Distribution of the VDT's connected to the two printers for service is flexible. When Feature 5775 is used, the VDT's must be equipped with Feature 5762, Printer Adapter.

The Print Control logic scans the Print Adapter Feature of each VDT looking for a print request. When this is detected, the scanning halts and the printer is activated. When the printing is complete, the scanning resumes. RCA 6742, 6752, or Teletype Corporation Inktronic printers may be used.

MODEL 8740 DATA TERMINAL

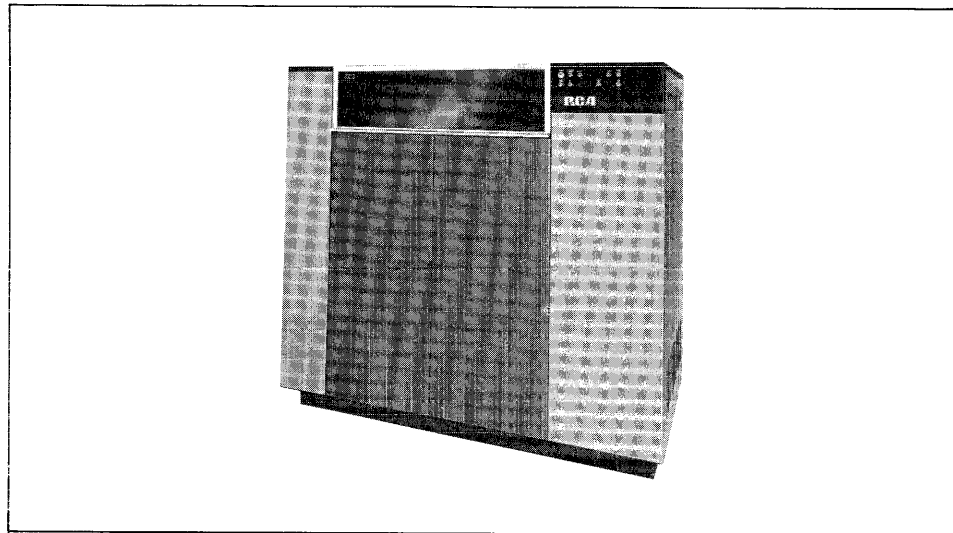

RCA 8740 Data Terminal is a high-speed remote line printer (up to 600 lines-per-minute) and control electronics that exchanges data with an RCA Series processor over a voice-grade communications line.

This remote facility communicates with the RCA processor by way of the 8668 CCM (8621 Synchronous Data Set Buffer) or by way of the Model 8656 Communications Controller-Single Channel at synchronous line speeds of 2000 or 2400 bits per second using ANSCII line code and line control procedures. The 8740 may operate on a point-to-point or multipoint private line or on the dialed network.

The basic 8740 consists of a printer and communications control electronics and operates in a message reception mode.

Transmission from the 8740, under this arrangement, is limited to message acknowledgements, error reporting, and other types of control information. The 8740 is capable of transmitting messages if the 8741 Card Reader is used.

Messages received by the 8740 are checked for proper character parity, block or subblock parity, block number, and format and additional accuracy and timing checks. Any error detected is reported to the processor by a special acknowledge sequence.

Characteristics

| | |
|---------------------------|---|
| Transmitting speed: | 2000 bits per second on dialed network Up to 9600 bits per second on leased line |
| Printer speed: | Up to 600 lines-per-minute |
| Transmission technique: | ANSII synchronous |
| Line code: | ANSII synchronous |
| Line control procedures: | ANSII |
| Print positions per line: | Model 8740-011–80 Model 8740-012–132 |
| Character set: | Standard is 64 characters |
| Printer paper width: | 4 to 18 ¾ inches |
| Printer paper length: | 17 inches (fold length), 3 inches minimum |

Special Features

Feature 5750-01 – Special Print Symbols (ANSII) – replaces the standard print drum with one containing ANSCII graphic characters.

Feature 5753 – Card Reader Adapter (EBCDIC/ANSII) – enables the 8740 to operate a Model 8741 Card Reader.

MODEL 8741 CARD READER

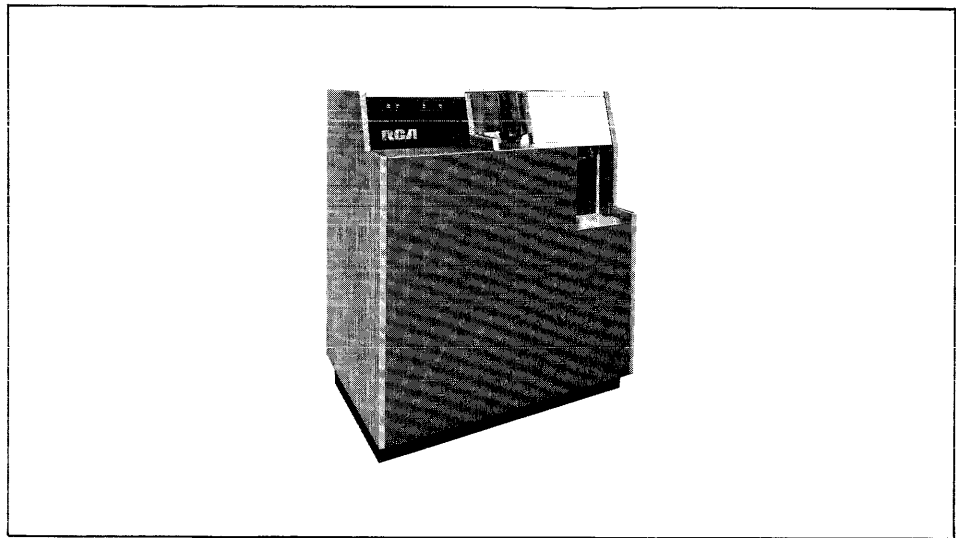

The RCA 8741 Card Reader is a punched hole and mark-sense card input device for the Model 8740 Data Terminal used to send data to the processor. The 8741 reads standard 80-column cards at a rate of up to 300 cards per minute. The input hopper and output stacker hold 1000 cards each; cards can be loaded and unloaded during card-reading operation.

MODEL 8762 DATA TERMINAL

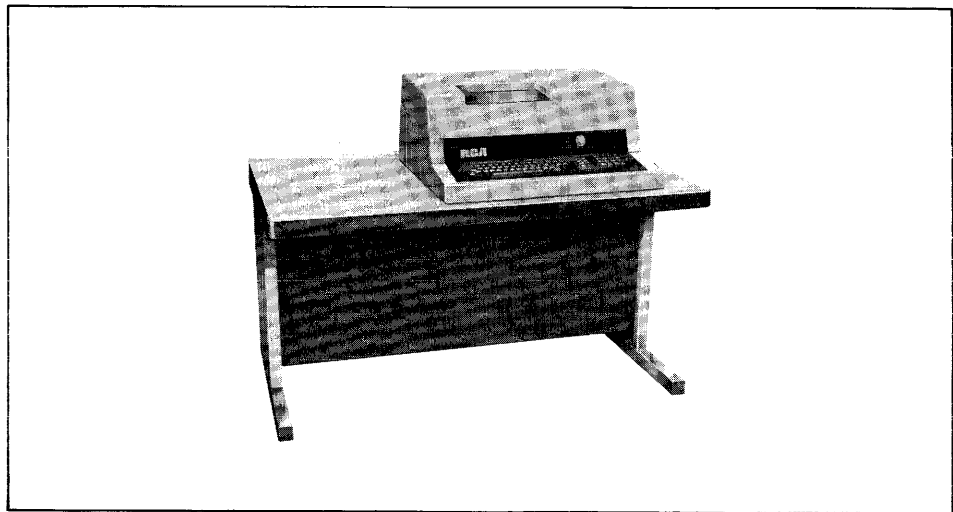

The RCA 8762 Data Terminal is a flexible, general-purpose, self-contained, buffered, full upper-and lower-case ANSCII keyboard (total 96 characters) printing terminal with line and program compatibility with the RCA 8752-200 Video Data Terminal. The RCA 8762 can be used on the same multipoint leased line as the RCA 8752-200, using the same communication controller, the same buffers, and the same resident line program in the

processor. The RCA 8762 and the RCA 8752-200 can also alternately dial the same buffer in the communication controller if both devices are on message network lines. The RCA 8762 is completely compatible with the RCA 8755-200 Data Terminal Switch. As many as 16 terminals, in any combination of 8762's and 8752-200's, can share a Data Terminal Switch at one location and operate over a single voice-grade line to a processor.

A full editing capability includes forward space, reverse space, line return, reverse line, and text line controls. Processor independent automatic retransmit capabilities minimize the need to run maintenance routines on the processor.

The available no-cost options are as follows:

Processor Override – A two-position switch, located on the rear of the terminal, which is available to disable optionally or to allow an incoming message to force the RCA 8762 into receive mode.

Message Identification – provides automatic generation of a unique terminal identification character included in all transmissions from the terminal to identify each particular RCA 8762. This option must be specified when the Unattended Mode Feature or Automatic-retransmit Feature is installed.

Transmission Rate Option (Asynchronous Mode Only) – permits the terminal to operate at either 200, 600, 1200, or 2400 bits per second.

Special Features

Feature 5778 – Station Selection – allows a theoretical limit of up to 96 RCA 8762's or combinations of RCA 8752-200's and RCA 8762's to be connected on a single leased-line communications circuit which interfaces to a central processor. The processor polls each terminal for messages to be sent to the processor or calls (selects) each terminal to transmit messages to an individual machine or to any group of machines with the broadcast capability.

Feature 5779 – Non-Print Function – allows entry of confidential information (for example, file access codes) into the terminal buffer. Pressing a Non-Print Key suppresses printing on the control panel. Printing will remain suppressed until the key is released. The security of the information entered into the buffer after using the Non-Print Function is assured if the COPY key is subsequently pressed. The machine will space over the positions previously entered when the Non-Print Button was pressed.

Feature 5780 – Break Function – provides an additional break key on the keyboard for signaling purposes. Pressing this key during reception of data from the processor sends a signal back to the processor for interpretation by the program by way of a Reverse Channel Signal.

This feature can only be used if the associated data set is provided with a Reverse Channel Feature, an extra cost feature on AT&T 202C or 202D Data Sets. This feature cannot be installed into machines which include the Synchronous Operation Feature or the Station Selection Feature.

It is a requirement that a Reverse Channel Buffer similar to the 8620-022 ADS Buffer be used in the communications controller when this special feature is selected.

Feature 5781 – Data Set Cables – permits the customer to choose between a 5-foot (5781-5), 25-foot (5781-25), or 50-foot cable (5781-50) to connect the terminal to the data set.

Feature 5782 – Data Format (Model 8762-021 only) – allows variable formats (field or item identifiers, headings, etc.) and other constant information to be called up from the processor and stored in the buffer of the RCA 8762. A format may be applicable to data being sent to the terminal or received from the terminal; in both cases after a format is resident in the buffer, only variable information is transmitted or received.

For keyboard entry under format control, the format information is printed or skipped over until a variable entry is required at which time printing or spacing stops. After variable information is inserted, the next format heading may be accessed by the pressing of the Horizontal Tab Key. If a variable entry into a fixed-length field is required, the automatic positioning of the next format entry occurs when the variable-field length is exhausted.

A feature – Message Address Store – of this terminal permits a response to be directed to a buffer address location which follows the buffer area reserved for the inquiry under format control. This feature assures that the format headings or variable data field are not overwritten by the processor response to the terminal.

Feature 5794 – Synchronous Operation – by the addition of this special feature, the RCA 8762 can be configured to operate synchronously (character framing accomplished by a series of sync characters which precedes transmission) at a transmission speed derived from the data set. Operation on message network lines using an AT&T 201A Data Set (5794-1) at a nominal rate of 2000 bits per second can be used. In a private line arrangement, an AT&T 201B Data Set (5794-2) at a nominal rate of 2400 bits per second can be used.

Feature 5795 – Transaction Keys – provides four keys to the operator which can be used for identification of a particular message type, or to convey certain code information to the processor, such as identifier for a specific format. Pressing any one of these keys after the ENTER key is pressed, loads a nonprintable ANSCII control character into the buffer and turns on appropriate indicator on the front of the machine until the SEND key is pressed. The keys are identified as I, II, III, and IV which develop the ANSCII characters FS, GS, RS, and US, respectively. Combinations of these keys can also be used if greater flexibility is required.

Feature 5796 – Buffer Expansion from 500 to 1000 Characters – increases the buffer memory size of the 8762 to 1000 characters.

Special Feature 5797 – Buffer Expansion from 500 to 2000 Character – increases the buffer memory size of the 8762 to 2000 characters.

Feature 5798 – Automatic Retransmit – Upon receipt of an error from the processor in the normal mode, the terminal, without this feature, prints an Underscore character in lieu of the character received in error. With the inclusion of this special feature, the terminal conveys an error report back to the processor for retransmission of the message. Printing will not take place until a complete message is received which contains no errors.

Feature 5799 – Unattended Operation – permits a message to be automatically received and printed without the presence of an operator at the terminal. With the inclusion of this special feature, an unattended mode switch position switch is enabled on the terminal control panel. Using the unattended mode, a request for retransmission is always generated to the processor upon detection of a parity error, buffer overflow error, or format error on received data.

Feature 5800 – Local Operation – permits direct connection to the communications controller. Operation is in asynchronous mode at 1200 or 2400 bits per second. The maximum allowable cable distance from the terminal to the communications controller is 50 feet.

MODEL 6701 DATA TERMINAL COUPLER

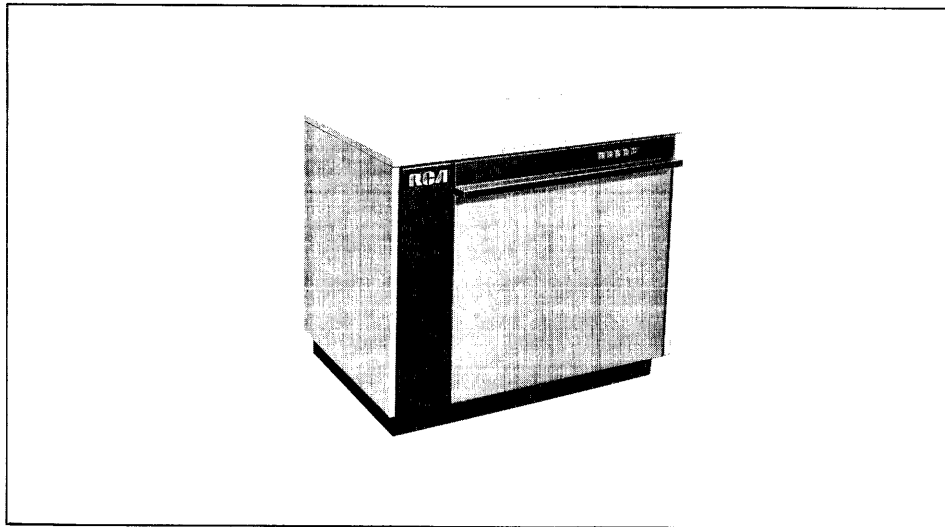

The RCA 6701 Data Terminal Coupler provides a hardware interconnection among the RCA data terminals and the IBM 360-30, 40, 50, 65, 75, IBM 370-155, and 165. The RCA 6701 can control from one to eight transmission lines at speeds of from 300 to 2400 bits per second. Operation may be either half- or full-duplex. The RCA terminal devices supported by the RCA 6701 are:

8752-100 Video Data Terminal

8752-200 Video Data Terminal

8755-100 Video Data Switch

8755-200 Data Terminal Switch

8759-021 Video Data Controller

8756 Video Data Generator

8751 Video Data Terminal

8762 Data Terminal

See Appendix F for typical data terminal configurations.

The 6701 Data Terminal Coupler is capable of interfacing the RCA Video Data Systems and the data terminal to 360 systems. The 6701 controls from one to eight transmission lines at speeds of 300 bps up to 2400 bps. These facilities may be operated either full- or half-duplex.

The communications may be by way of leased-line facilities or the switched network (dial). The transmission code used between the terminals, the 6701, and the IBM 360 is ANSCII. Data on the communication lines is transmitted serially by bit and serially by character. Data transferred between the 6701 and the IBM 360 multiplexor channel is parallel by bit, serially by characters.

The 6701 performs the following basic functions when interconnecting the terminals and the IBM System/360.

1. Establishes connection between the central complex and the terminals.
2. Implements data transfers between the channel and the terminals.
3. Indicates to the channel the status of the communications lines.
4. Provides validity check on the received data.
5. Deletes and inserts start and stop bits from asynchronous transmissions.
6. Generates, recognizes, and deletes synchronizing patterns on synchronous transmissions.
7. Generates time-outs to prevent system lock-ups.

The 6701 consists of the channel interface, the common controls, and the transmission adapters.

1. The channel interface provides the logical control between the 6701 and the 360; recognizes signal sequences from the channel and returns the required sequences in response; transfers data between the System/360 multiplexor channel and the 6701 Channel Interface in a single-byte multiplex mode. Each byte is in ANSCII code and consists of eight data bits, plus one parity bit (odd).

2. The common controls perform all functions that are common to all communications lines. The data bytes received from the channel interface in bit-parallel/byte serial form are converted to bit serial/byte serial for transfer through the transmission adapters. The common controls, in reverse, transfer data through the channel interface to the channel in bit-parallel form in data-interleave (multiplex) mode.

3. The transmission adapters provide the circuits for connection of remote terminals to the 6701 and provide proper control of the transmission facilities.

There are two types of transmission adapters: asynchronous (6722) and synchronous (6723). The transmission speeds supported by the asynchronous adapter are 300, 600, 1200, 1800 and 2400 bps. The synchronous adapter supports speeds of 2000 and 2400 bps.

The transmission adapters may run in either the full-duplex or half-duplex mode. In the half-duplex mode one device address is used for an adapter, while two-device addresses must be assigned for full-duplex operation even though each transmission adapter only takes one of the eight positions in the 6701.

MODEL 6711 DATA SET

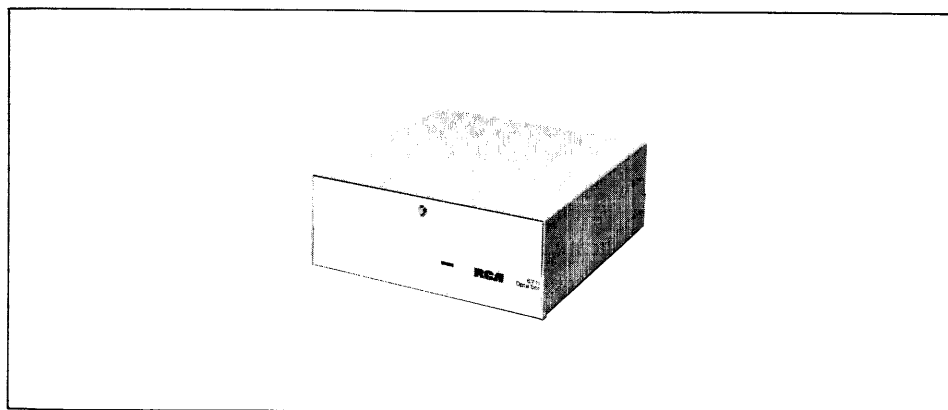

The RCA 6711 Data Set is a medium-speed, asynchronous, serial transmitter/receiver used for the transmission of data over voice-grade communications facilities. This desk-mounted data set is line-compatible with the Bell System 202 Series Data Set and will initially be used on systems incorporating the 8750 Video Data Systems. The RCA 6711 Data Set can operate up to 1800 bits per second; actual speed being dependent upon type of line conditioning provided in a particular communications configuration. Timing must be provided by the data terminal equipment.

The RCA 6711 can operate over two- or four-wire communication facility. Over a four-wire facility, the set can operate in either a full- or half-duplex mode. On a two-wire arrangement, the set can operate in either half-duplex or simplex mode.

In the transmit mode, the RCA 6711 modulates (convert) binary serial dc pulses into frequency shift signals for transmission over the communications facility. In the receive mode, the data set demodulates (reconvert) the frequency signals into binary serial dc levels (pulses).

The Model 6711 Data Set can be used on either a private line facility or over the general switched telephone network (DDD). When used on the DDD network, the Model 6711 must interface to the AT&T data access arrangement and is restricted to manual dial and manual answer/disconnect.

In view of the distortion and frequency deviation which can be encountered on certain unconditioned private line communications facilities, the following guidelines are provided:

Up to 1200 bits/second - Unconditioned lines

Up to 1400 bits/second - C1 conditioning

Up to 1800 bits/second - C2 conditioning

Whenever the data rate exceeds 1000 bits/second, consideration should be given to C1 conditioning to insure the desired quality of data transmission.

All controls are readily accessible to the user. These include:

Power on/off switch

Power operable indicator light (indicates ac power is on)

Operate/locate test/remote test switch

Special Feature and Options

Feature 587 – Reverse Channel Option – used on two-wire facilities where a requirement exists for simultaneous supervisory communications during periods of data transmission. This supervisory communications is in the opposite direction to the flow of data.

Two-wire or four-wire operation.

Transmitter Output Level Option – provides selection of output levels of 0dbm, -3dbm, -6dbm, -9dbm.

Clear-to-Send Delay Option – permits selection of either a 10-, 60-, or 200-milliseconds delay, after placing the request-to-send switch on.

Data Clamp Option – Clamps received data to a steady marking condition until the data carrier detector circuit comes on.

Squelch Option – Holds the output of received data to a steady marking condition for a period of 150 milliseconds whenever the request to send circuit goes from on to off.

Comprise Delay and Amplitude Equalizer Option – provides a three-position circuit to compensate for distortion on a communication line.

Soft Carrier Turn Off Option – used to prevent abrupt turn off of carrier signal at the end of transmission.

MODEL 6740, 6741, and 6742 TELETYPEWRITERS

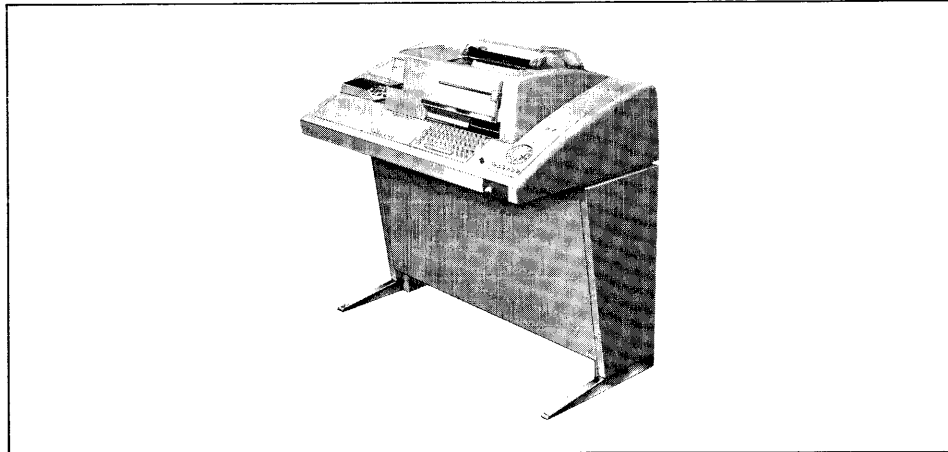

The RCA 6740, 6741, and 6742 Teletypewriters are four-row keyboard units that provide terminal facilities for receiving and transmitting page-printed messages over an appropriate communications line. The Models 6740, 6741, and 6742 are comparable to the Teletype Model 35 (private-line version). The units are capable of speeds of 10 characters per second, use the ANSCII code on the communications line, and can be provided with paper tape punch and paper tape read capabilities. The 6740, 6741, and 6742 Teletypewriters interface with a two-wire circuit (an RCA 6793 must be installed to supply line loop current) for local operation or, when the Data Set Coupler (Feature 563) is connected, with the Bell System Data-Phone® service, private voice-grade lines, 150-baud private line channels, or equivalents.

The following model numbers are applicable to the 6740, 6741, and 6742:

| <u>Model</u> | <u>Description</u> |
|--------------|--|
| 6740-11 | Automatic Send-Receive terminal with: keyboard, printer (friction-feed platen), paper tape reader, paper tape punch. |
| 6740-21 | Automatic Send-Receive terminal with: keyboard printer (sprocket-feed platen), paper tape reader, paper tape punch. |
| 6741-11 | Send-Receive terminal with: keyboard and printer (sprocket-feed platen). |
| 6742-11 | Receive-Only terminal with: printer (friction-feed platen). |
| 6742-21 | Receive-Only terminal with: printer (sprocket-feed platen). |

When the Models 6740, 6741, or 6742 Teletypewriters are used with a local, two-wire, customer-supplied line circuit, they can be connected to a Model 8610 Telegraph Buffer or a Model 6020-11 Communications Buffer only. Feature 563 with the Model 8620-021, 022, 023 ADS Buffer or Model 6020-11, -12 Communication Buffer is used with the following communication line facilities.

1. Bell System voice channel (dialed network) with a Model 103A Data Set or equivalent.
2. Bell System voice channel (private line) with a Model 103F Data Set or equivalent.
3. Bell System 150-baud channel (Type 1006) with appropriate termination device with AT&T 108 Data Set (or equivalent).
4. Western Union Class D channel with a Model 1181.1 Data Set or equivalent.

With Feature 563, the Models 6740, 6741, or 6742 can provide direct cable connection to a 8752 Video Data Terminal with Printer Adapter Feature 5711.

Special Features

Feature 563 – Data Set Coupler – provides a coupler which accepts and converts signals from the teletypewriter for transmission to the data set and receives and converts signals from the data set for use by the teletypewriter. The Data Set Coupler feature can interface either a Bell System 103A, or 103F Data Set, or a Bell System 150-baud, private-line channel, or equivalents. The Data Set Coupler feature is also required when the teletypewriter is connected to a 8752 Video Data Terminal equipped with the Printer Adapter Feature 5711.

Feature 564 – Wide Carriage – replaces the standard sprocket-feed carriage with a wider carriage to handle continuous form-feed stationery up to 9 inches wide. The maximum print area is 8.5 inches, permitting up to 84 characters per line.

Feature 585 – X-On, X-Off Operation – modifies either Model 6740-11 or -21 Teletypewriter (ASR-35) by providing for the automatic starting of the transmitter when the X-On character is received. When the X-Off character is read from tape, the transmitter stops automatically.

Feature 5259 – Forms Supply Box Feature – provides a forms supply box and accumulating shelf for the handling of continuous form-feed stationery.

MODEL 6750, 6751 and 6752 TELETYPEWRITERS

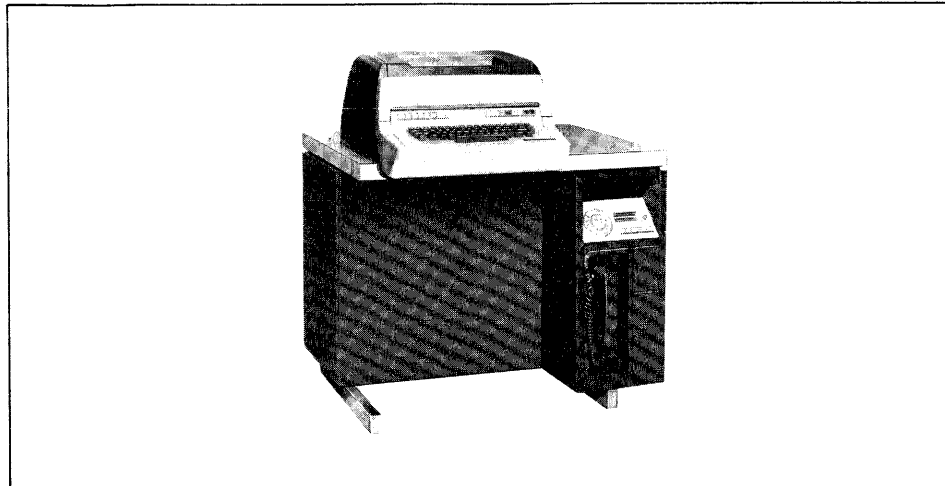

The RCA 6750, 6751, and 6752 Teletypewriters comprise a fast, flexible series of teletypewriters designed to complement the RCA 6740 Series Teletypewriters. The RCA 6750 series offers the same reliability as the RCA 6740 series and, in addition, are oriented toward customer applications which require upper- and lower-case operation and increased throughput capability.

The 6750 Series Teletypewriters operate as computer input/output devices in (1) a point-to-point private line network using the RCA 6711 or the Bell System 103F/103H Data Sets; (2) a private subvoice, 150-baud network using the Bell System 108 Data Set; or (3) a Data-Phone arrangement using the RCA 6711 Data Set with the data access arrangement or the Bell System 103A/103E Data Sets.

The RCA 6752 can be used in conjunction with an RCA 8752-200 with printer adapter feature to provide a hard copy output for the Video Data Terminals. These teletypewriters cannot be used on customer-provided dc in-house circuits. The capability to attach these terminals to a multipoint private line is not presently available.

The following models are available:

| <u>Model No.</u> | <u>Description</u> |
|------------------|---|
| 6750-11 | Automatic Send/Receive Unit with keyboard, friction-feed printer, paper tape reader, paper tape punch, tape storage bins and tape winder. |
| 6750-21 | Same as Model 6750-11 except with a sprocket-feed printer and a motor-operated paper tape winder/unwinder. |
| 6751-11 | Keyboard Send/Receive Unit with keyboard and friction-feed printer. |

6751-21 Same as Model 6751-11 except with a sprocket-feed printer.

6752-11 Receive Only Unit with friction-feed printer.

6752-21 Same as Model 6752-11 except with a sprocket-feed printer.

Standard features on all units include:

15 characters-per-second printing speed
(150 bit-per-second transmission speed).

ANSII Code

Upper/lower case operation, 94 graphics can be printed, 128 character combinations can be generated.

82-character printing line, 10 characters per inch, horizontal spacing, 6 lines per inch vertical spacing.

EIA RS232C data set interface

Horizontal tabulation operation

Horizontal tabulation stops set or cleared from the keyboard or from a character sequence from the line.

Even-character parity generation and checking capability.

Work station with an operator work space.

A 50-foot data set interface cable.

For all sprocket-feed models, the following additional standard features are included:

Reverse line feed controlled from the keyboard or from the line.

Half-line feed, forward and reverse, controlled from the keyboard or from a character sequence from the line.

Vertical tabulation operation

Vertical tabulation stops set and cleared from the keyboard or a character sequence from the line.

Two-color fabric ribbon, color-position controlled from the keyboard or from a character sequence from the line.

Rear paper loading and continuous forms holder and stacker in the work station.

Field installable, no cost, options available include:

Half- or full-Duplex option, 6750-11 or -21 only – these units are equipped for half-duplex operation. A modification can be field installed which permits the full-duplex operation, transmission of data from the paper tape reader while data is received by the printer. To use this option, a full-duplex data set, for example, AT&T 103A, 103F or an RCA 6711 on four-wire service, must be installed at the terminal as well as the computer end of the circuit. If using an 8668 CCM, two 8620 ADS Buffers with a SF 5714-1 is also required for each line termination.

Note: This option is presently not supported by RCA-supplied software.

Automatic Carriage Return Disable Option – Normally all units recognize a line feed (LF) character and automatically perform the carriage return function as well as increment the printer line position. If the customer so desires, this capability can be disabled to require the terminal to recognize a discrete Carriage Return (CR), in addition to the Line Feed character before a carriage return and line index function is performed. This option has no effect on RCA software.

MODEL 6793 POWER SUPPLY

The RCA 6793 Power Supply provides the telegraph line power for installations which require this service. The Model 6793, by supplying line power, enables all RCA 6740 Series Teletypewriters to communicate (local service) with an RCA system by way of the Model 8610 Telegraph Buffer.

Section 12: PUBLICATIONS PLAN FOR RCA SERIES PERIPHERAL DEVICES

GENERAL

Publications for the RCA Series peripheral devices are depicted in figure 2-13. The applicable publication ordering numbers will be supplied as these publications are made available. Each type of publication represented is described briefly in this section.

The publications are grouped according to the audience to which they are directed:

1. General reader: all users, but specifically corporate and information processing management.
2. Technical reader: operators, programmers, systems personnel.

The basic publication for corporate and information processing management is the RCA Series Systems Information Manual. This manual provides the RCA Series family of related equipment and operating systems with emphasis on user benefits. This initial overview stresses special features, operational advantages, and individual components and component structure. The level of detail is intended for planning purposes, not for actual programming or operation of the equipment.

The basic publication for the technical reader is the Reference and Operating Manual for each peripheral device. This manual provides a comprehensive description of the peripheral device including functional characteristics, operational modes, optional features, controls and indicators, accuracy controls, and programming considerations. Also included is a discussion on the operators control panel and operating procedures.

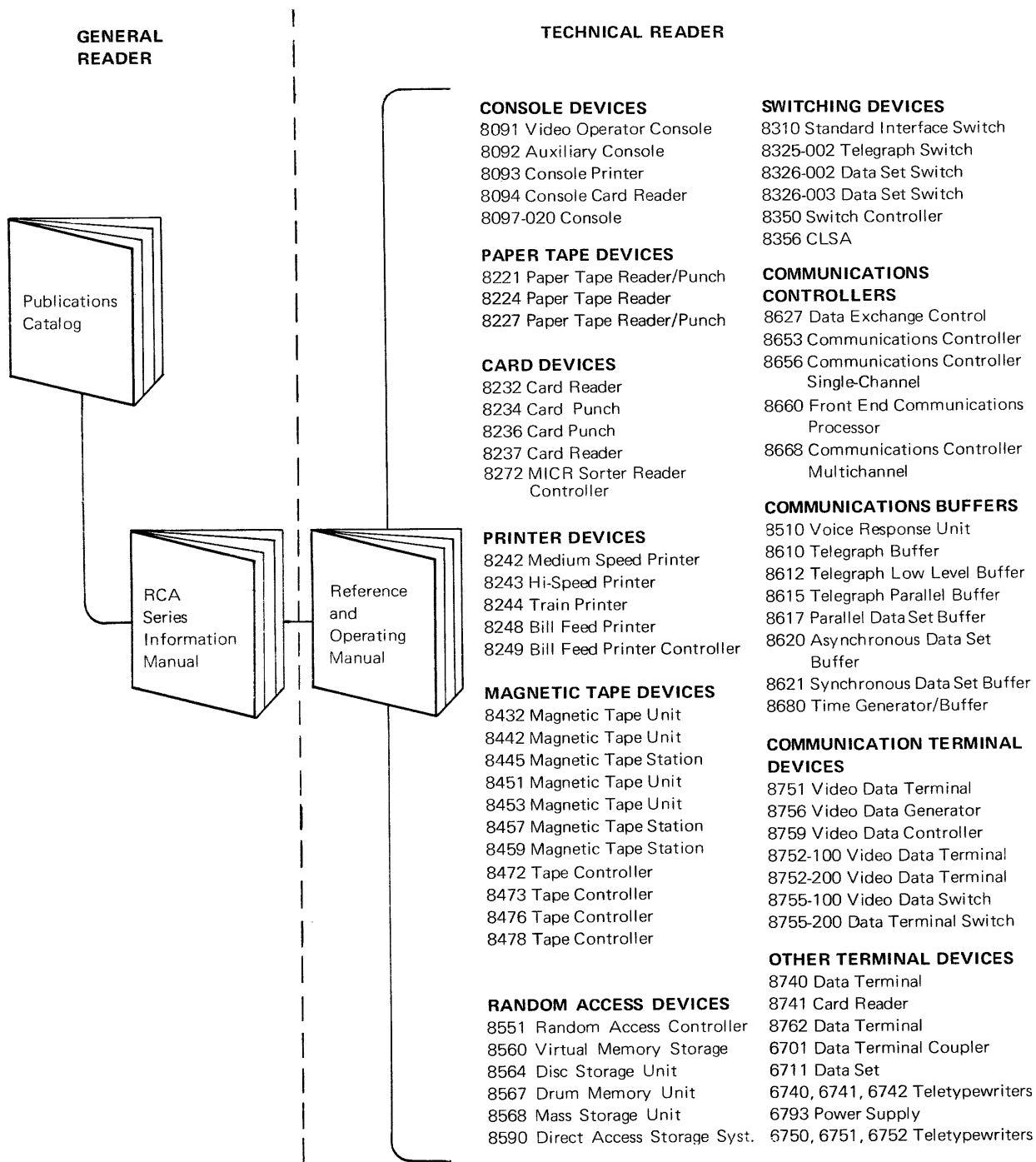

FIGURE 2-13. PUBLICATIONS PLAN FOR RCA SERIES DEVICES

Operating System (OS/70)

INTRODUCTION

The Operating System 70 (OS/70) presents to the user a powerful, advanced operating system for controlling real-memory, batch processing, and communications operating environment. OS/70, in support of the users' broad mix of information processing requirements, provides total environmental support for the RCA 2 and RCA 6 Processors and the RCA 3 and RCA 7 Processors when operating in the real-memory mode.

Within the design of the OS/70 system complete support of processor control, programming languages, communication data management, and utility systems is maintained.

The minimum required equipment configuration is as follows:

| <u>Model No.</u> | <u>Quantity</u> | <u>Description</u> |
|------------------------|-----------------|-------------------------------------|
| RCA 2, 3, 6, or 7 | 1 | Processor (minimum 65,536KB memory) |
| 8564 | 2 | Disc Storage Units |
| 8097-020 | 1 | Operator Console |
| 8242, 8243, or 8244 | 1 | Printer |
| 8237 | 1 | Card Reader |

Section 1: OPERATING SYSTEM 70 (OS/70) OVERVIEW

GENERAL

OS/70 through control of basic system resources, language facilities, and communications capabilities provides a total user-application environment for system development, diagnostic checkout, and program storage and maintenance. The principal features of OS/70 are listed below:

1. Minimal resident memory requirements for control programs.
2. Multiprogramming/multitasking support.
3. Automatic spool-in and spool-out capabilities.
4. Comprehensive data management facilities including:
 - a. Multilevel data set catalog,
 - b. Dynamic random access space allocation and file extension,
 - c. Extensive file security,
 - d. File back-up and reconstruction facilities, and
 - e. Common code I/O processing logic.
5. A priority-oriented Job Scheduler that provides automatic program initiation and a powerful job control language.
6. Remote job entry.

Section 2: SYSTEM COMPONENTS

GENERAL

Each of the OS/70 system features and functions is provided through a logical grouping of software components. Component categories are the Control System, Language System, Data Management System, Utility System, Communications System, Data Base Management System, Emulation, and Conversion Systems.

CONTROL SYSTEM

The Control System consists of the Executive, Job Scheduler, and Job Accounting.

1. The Executive controls the processor and multiprogramming environment.
2. The Job Scheduler provides a powerful job control language for the definition of program preparation requirements and the sequence of program execution.
3. Job Accounting provides for the accumulation of detailed job and program-related information.

LANGUAGE SYSTEM

The Language System provides a comprehensive set of language translators for problem definition and resolution. OS/70 language translators are disc-oriented and include COBOL and ANSI COBOL compilers, Report Program Generator, FORTRAN IV compiler, and Assembler.

DATA MANAGEMENT SYSTEM

The Data Management System provides both physical and logical level file processing support through varied-access methods. It features a sophisticated catalog concept for data control and manipulation as well as data protection facilities.

UTILITY SYSTEM

Utility functions within OS/70 are handled by the six basic components of the Utility System which provide for:

1. Library Maintenance
2. Data Conversion

3. Sort and Merge functions
4. Diagnostic functions
5. System Service functions
6. Job Reporting functions

COMMUNICATIONS SYSTEM

Communications capabilities are provided by the Communications System. A basic communications package meets the requirements of the small communications user, or serves as a base for tailored application packages. Communications Oriented Software (COS) serves the needs of the sophisticated communications user. Submission of jobs from remote terminals will be supported by a Remote Job Entry package that interfaces with the appropriate Control System components, such as spool-in, job scheduler, and spool-out.

EMULATION AND CONVERSIONS SYSTEM

The Emulation and Conversion System provides emulation capabilities for second generation RCA and non-RCA systems. It also provides conversion aids to simplify the transition from current Spectra 70 and IBM 360 systems to OS/70. OS/70 provides for the emulation of RCA 301, IBM 1401, 1440, 1460. Conversion aids will be provided for RCA 301, 3301, TOS, TDOS, and DOS Systems, as well as for IBM 360 Systems.

DATA BASE MANAGEMENT SYSTEM

The objective of the Data Base Management System is to provide flexible capabilities to allow the establishment, interrogation, and maintenance of an integrated data base.

GENERAL

Through a logical grouping of components, OS/70 offers a comprehensive complement of software functions designed to exercise total control over the vast number of system functions which the RCA Series systems are capable of performing. This section describes some of the functional concepts and capabilities of OS/70, namely Job Management, Data Management, Program Preparation, Program Execution, Input/Output Spooling, Job Accounting, System Generation, and Initiation.

JOB MANAGEMENT

A job describes the unit of work which a user wishes to have performed by the system. It is defined by a sequence of Job Control Language (JCL) statements specifying the programs, data sets, and resources required, and how these must interact to produce the desired results.

User Credential Files

A User-Credential file is maintained by the system to list authorized users by unique ID names and to provide information for job accounting and file routing.

Job Steps

A job step is a sequence of JCL statements within a job, providing run-time parameters, securing resources, and calling for the execution of any one single program.

Job Scheduler

The Job Scheduler's function is to optimize the utilization of system resources for maximum system throughput by determining the order in which jobs are initiated and their job steps executed. The determination of job-step (or program) execution is based on the available system resources, the required resources for each job-step ready for execution, and user-specified priorities. The status of jobs and job-steps pending execution can be interpreted and altered by operator console command.

Job Variables

A powerful facility provided under OS/70 job management is the Job Variable. A Job Variable is a uniquely identifiable entity consisting of a value that can be created, updated, and tested. Job variables provide both the user and the system with a flexible method of handling run-time parameters and communications within the system. It can be used to provide for both delayed and conditional program execution.

Job Macros

Sequences of JCL commands can be predefined and cataloged as job macros. These JCL commands replace the macro name that identifies them wherever that name is encountered within the job stream. This feature precludes the necessity of having multiple copies of common sequences of JCL statements.

Macro calls are satisfied by searching the user's private macro library for the JCL commands to replace the macro call. If the macro is not found in the user's macro library a search is made of the system macro library. In addition, fields within the expanded JCL statements (program name, data set identification etc.) can be defined as variables with the actual value being inserted at run time. This is accomplished through the use of job variables.

DATA MANAGEMENT

OS/70 provides a number of catalogs for data set processing and control as well as accounting for random access space and tape read availability.

Data Set Catalog

The Data Set Catalog allows the user to record the identification and characteristics (record size, blocking factor, etc.) of data sets. The structure of the data set ID allows the user to establish relationships between families of data sets and still qualify data set references by generation and version number.

Volume Catalog

The Volume Catalog is used by the system to keep track of available tape reels on R/A space.

On-Line Catalog

The On-Line Catalog is maintained by the system and contains the device location and volume identification of each random access and tape volume physically accessible by the system. Its use in conjunction with the other catalogs allows the user to locate the appropriate random access volume or data set on the basis of data set and/or volume identification alone.

Access Methods

Data Management provides a number of access methods for data set processing. This includes data sets organized in a direct, sequential, serial, or indexed sequential manner. These access methods will take advantage of OS/70 common code facilities that allow multiple programs to utilize the same sharable logic. Common code usage reduces total memory requirements for data management access logic by a factor of the number of programs greater than one using that access method at the same time.

Random Access Allocation And Extension

Random access space for data sets may be previously allocated or allocated at run time. Secondary allocation requirements can be predefined in the event initial space allocation is insufficient, or requested dynamically at run time.

Data Protection

Extensive data protection is provided through the use of data set identification checks and owner and authorized access and update identification codes. To prevent the simultaneous access of the same data block by multiple programs updating the same data set, there is a block lockout feature. This feature insures that the first program to access a particular block has released it prior to its being accessed by another program.

File Backup And Reconstruction

OS/70 provides for automatic logging of record images to tape before and after processing as well as routines for random access to tape data sets transcription. In the event of accidental file destruction or record loss, this information is available for partial or entire file reconstruction.

PROGRAM PREPARATION

Random Access File Areas

For the storage of libraries and random access work areas involved in program preparation OS/70 uses two random access file areas identified by the names SYSFILES and SYSLIB. Within both these file areas space is dynamically allocated and returned when no longer needed.

SYSFILES is a single or multiple extents partitioned random access file (as reflected by the VTOC) contained on a single volume. It is designed for use by system components requiring random access space on an indefinite or temporary basis for a number of purposes including libraries, spool data storage, catalogs, and libraries.

SYSLIB is a single extent random access file area whose use under OS/70 will be devoted to the storage of source and macro libraries. The processing and maintenance of SYSLIB space involve a simple but efficient technique of allocating space on an "as-required" basis. Space occupied by a single library, or element of a library need not be contiguous and is reusable when the element or library is deleted.

Libraries

OS/70 provides for the creation, maintenance and utilization of three libraries in program preparation and execution. These are the Source Program Library, Macro Library, and Unified Load Library.

Two of these libraries, Source Program and Macro, will initially be contained in SYSLIB. Eventually they will be intergrated into SYSFILES. The Unified Load library exists as a partition of SYSFILES.

The Source library contains the source program input to the language translator.

The Macro library contains the source statements required to satisfy macro calls within assembly programs, when those calls use in-line coding for macro functions.

The Unified Load library contains both bound programs that have been processed by the static Linkage Editor and unbound module output from language translators that has not been processed by Linkage Editor.

Program Flow

Figure 3-1 illustrates the flow of a program from the source level to execution and the relationship of the libraries involved.

The language processors receives either an anonymous input deck directly via SYSIPT (which may be spooled-in), or a named input deck from SYSLIB. Cataloging a source deck into SYSLIB is a function of the SYSLIB maintenance routine. Subsequently the deck may be altered and copied by the various library maintenance routines before being submitted to a language processor. If the source input was not cataloged it would have disappeared from the system after processing.

The output of the language translators is one or several modules consisting of text, relocation, and external symbol dictionary information. As an option a module also contains an internal symbol dictionary establishing relationships between symbolic names and their corresponding memory locations. Modules are left by the language translator in a translation work area in SYSFILES for subsequent processing. In addition, there is an option to output the module to SYSOPT (tape or punch) either directly or through the spool-out function.

After translation the modules may follow a number of processing paths. The modules could be cataloged into the Unified Load library by a library maintenance routine. They could then be linked by the static Linkage Editor who would satisfy certain external references and catalog the bound program into the Unified Load library.

Modules from the Unified Load library bound or unbound are loaded for execution by the dynamic Linking Loader or Debug Loader. These loaders satisfy all hitherto unsatisfied external references to both private and common code and handle V-CONS for overlay references. In addition, the Debug Loader evaluates symbolic debug instructions and substitutes core addresses for names using the Internal Symbol Dictionary (if present). After loading the program, but before giving control to it, the Debug Loader also inserts traps and patches as specified in the debug instructions.

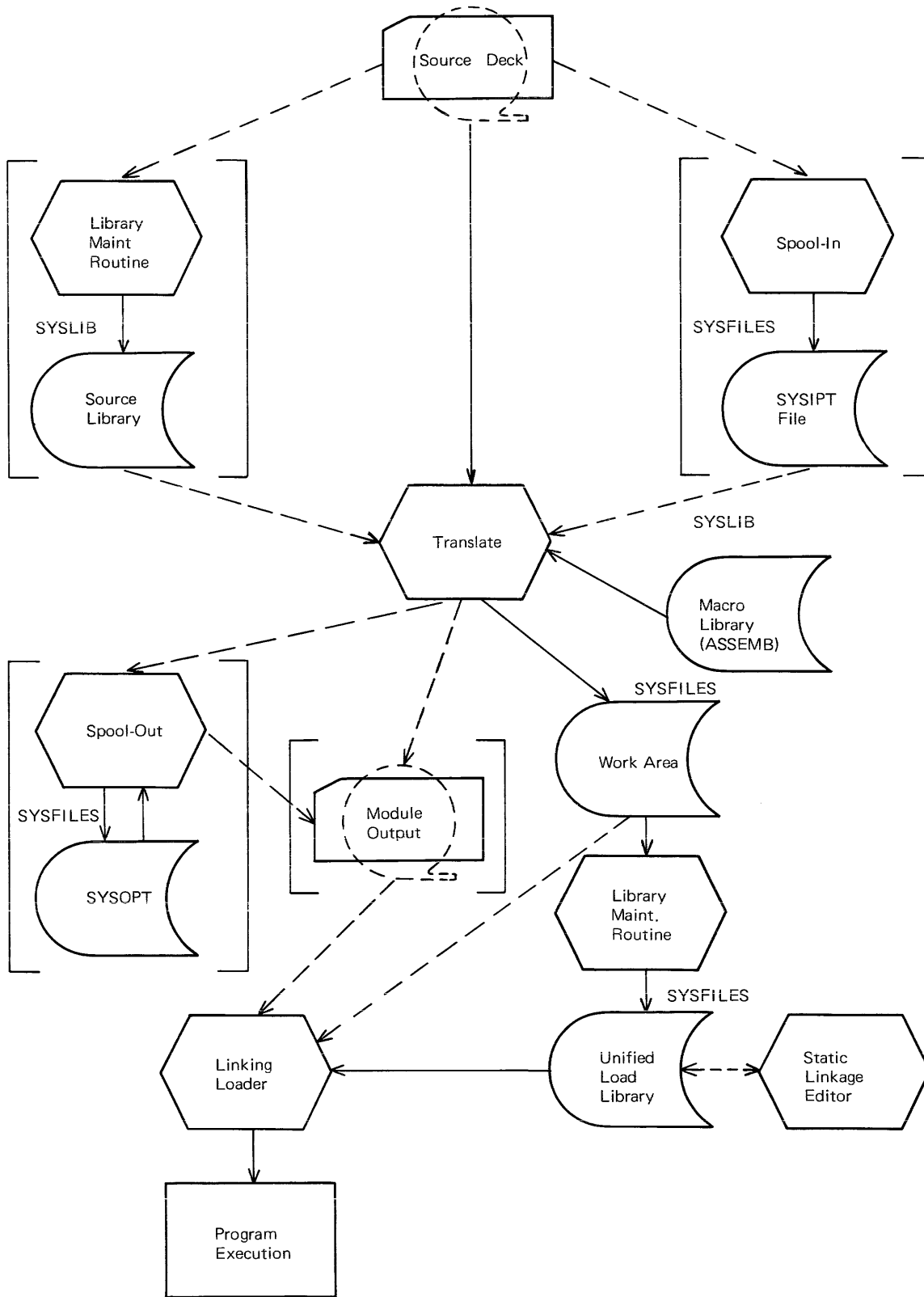

FIGURE 3-1. OS/70 PROGRAM PREPARATION CONCEPT

Unbound modules may also be processed by inputting them directly to the Linking or Debug Loader, from the SYSFILES work area or by using the option SYSOPT deck (cards or tape).

PROGRAM EXECUTION

Multiprogramming

Multiprogramming is the sharing of the processor by concurrently executing programs to optimize processor usage. OS/70 provides for the concurrent execution of up to 14 programs with the memory assigned to each program protected from all other programs. In a multiprogramming environment the allocation of processing time is based on a flexible priority scheme normally established by the system but subject to alternation at the user's discretion.

Multitasking

Multitasking is the division of a program into work units so that more than one unit of the program can compete concurrently for control of the central processing unit. In OS/70 the work units are referred to as tasks. A task is a loaded routine for which all resources necessary for the execution of the instruction are already allocated (except perhaps the CPU).

A program is a set of dependent tasks. Dependent means that Executive Control Language commands are used for coordination of a program's tasks, and that the resources of the member tasks of a program are not protected against other member tasks of the same program. Each program may have up to 14 member tasks.

Dynamic Memory Allocation

After loading, a program may request additional main memory or return memory no longer needed. Additional memory areas allocated to a program subsequent to program initiation need not be contiguous to each other or to the initial memory assigned.

Common Code

System functions (such as Data Management access methods, macros, etc.) required by two or more programs are implemented in the form of common (reentrant) code.

The routine is brought into memory if not already there when a program referencing it is loaded. Once in memory it can be shared by several users. These routines reside in memory reserved by the system but in essence are executed as part of each problem program requiring them. Common Code routines may be written by the user to provide substantial savings in program preparation time and memory requirements.

INPUT/OUTPUT SPOOLING

Spool-In

The spool-in function buffers all cards input (data, JCL and program control information) to an intermediate random access device. This permits the immediate release of the card device to support other jobs in the system. The spool-in function is transparent to the user who requests card input as if it were coming directly from a real card device. Random access space for the storage of spool-in data is dynamically acquired from SYSFILES and returned when the spool-in data is no longer required.

Spool-Out

The spool-out routine provides the facility for intercepting printer or punch destined data sets and storing them on a random access device until the data set is complete and the designated printer or punch is available. Its objective is to avoid job scheduling bottlenecks by simulating several "virtual" printers simultaneously and to speed up print or punch bound programs tying up other resources. The spool-out software is completely invisible to the programmer at the source level. As for spool-in data, random access space for spool-out is acquired from and returned to SYSFILES. Spool-out also features support for special forms handling, procedures for random access file saturation, and recovery procedures in the event of system failures.

JOB ACCOUNTING

OS/70 Job Accounting is an optional system component that stores pertinent information on each job and program executed in the system. This information is time and date stamped and stored in SYSFILES. It pertains to resource utilization, operator and program comments, and detailed job events such as: job spool-in time, job reception point (local or remote), initial job priority, priority change, job-step load time, sub-task utilization, job step termination conditions (time, cause, etc.), output destination point (local or remote), spool-out time.

Report Writer

In conjunction with Job Accounting there is a parameter-driven Report Writer routine to utilize the stored accounting information for the generation of reports tailored to the user's information requirements. The Report Writer has the capability of summarizing by various levels of control such as job number and device usage.

SYSTEMS GENERATION AND INITIALIZATION

System Generation

The procedure for system generation in OS/70 uses the technique of allowing the operating system to adapt itself to requests for special services as they arise. This makes the time-consuming procedure of assembling a "customized" system for an extensive macro-generation unnecessary; the full range of system capabilities is always available should an unforeseen need arise.

System generation consists of volume initialization, file allocation, and library transcription, with a master tape used as the system residence device. As soon as the necessary components are transcribed to the random access device, it becomes the system residence device. Control is then passed to the System Initialization routine.

System Initialization

System initialization is the process of loading the system from an external carrier, and adapting it to its hardware environment.

Certain parameters determining the characteristics of the operating system, or describing the environment in which it should run, will be evaluated during system initiation. Individual parameter sets may be pre-catalogued, so that only a set designation is needed to cause the system to be "generated" accordingly. An important characteristic of the OS/70 Executive is the use of dynamic table structures, which make it unnecessary to state in advance the number of program table slots or symbolic device names to be supported. This technique also allows dynamic alterations to the physical device table (via operator console command).

Section 4: PUBLICATIONS PLAN FOR OPERATING SYSTEM 70 (OS/70)

This section presents the current plan for the development of user manuals required for implementation of the RCA OS/70 software system. The plan, as illustrated in figure 3-2, is primarily user-oriented. The complete set of manuals covers the needs of all user personnel. Document ordering numbers will be supplied as the documents become available. The documents represented in figure 3-2 are briefly described in this section.

All documents in the OS/70 publications plan are designed for specific users. These user/readers fall into two general categories:

1. General reader: all users, but specifically corporate and information processing management.
2. Technical reader: operators, programmers, system controllers, information processing specialists, and systems programmers.

The publication intended as the OS/70 overview for management personnel is the OS/70 Programming System Information Manual. This manual presents a description of the OS/70 structure, components, functions, and operation. The information is presented only to the depth necessary to provide an understanding of the operating system and to serve as a basis for using the other detailed system manuals. Included in this manual are topics such as system features, characteristics, advantages, and equipment requirements.

The Programming Management Manual provides the programmer with detailed instructions on how to use the system. The procedures cover the programming, running, and debugging of the OS/70 system.

The Data Management System Manual describes the input/output phase of the OS/70 system. The manual provides details of the input/output functions, system software, library structure, and file control language.

The System Management Manual describes the operation, functions, and structure of the OS/70 control system. Functions included in this manual are Job Management, Task Management, and Resource Management.

The Utility System Manual contains descriptions of all utility routines. The descriptions include detailed format and parameter information.

The Communication System Manual describes the communication capabilities of the OS/70 system. The manual covers the Basic Communication Support, Communication Oriented Software, and Remote Job Entry. Details of the Communication Control Language are also included.

The IBM Emulator Program Manual describes the OS/70 emulation software for IBM systems. The IBM systems emulated include the 1401, 1440, and 1410/7010.

The RCA Emulator Program Manual describes the OS/70 emulation software for other RCA systems. The RCA System emulated is the 301.

The Conversion Aids Macros Reference Manual describes the conversion aids provided for transition from earlier IBM and RCA systems. Conversion facilities are provided for IBM 360, RCA TDOS, and RCA 3301 programs.

The Remote Terminal Manual describes the use of the remote terminal in the OS/70 system. The manual includes all procedural and interpretive information associated with the terminal operation.

The Operator's Guide contains the instructions and information required by the console operator. The contents describe all printouts and typeouts, and provide operator instructions for initial actions and responses.

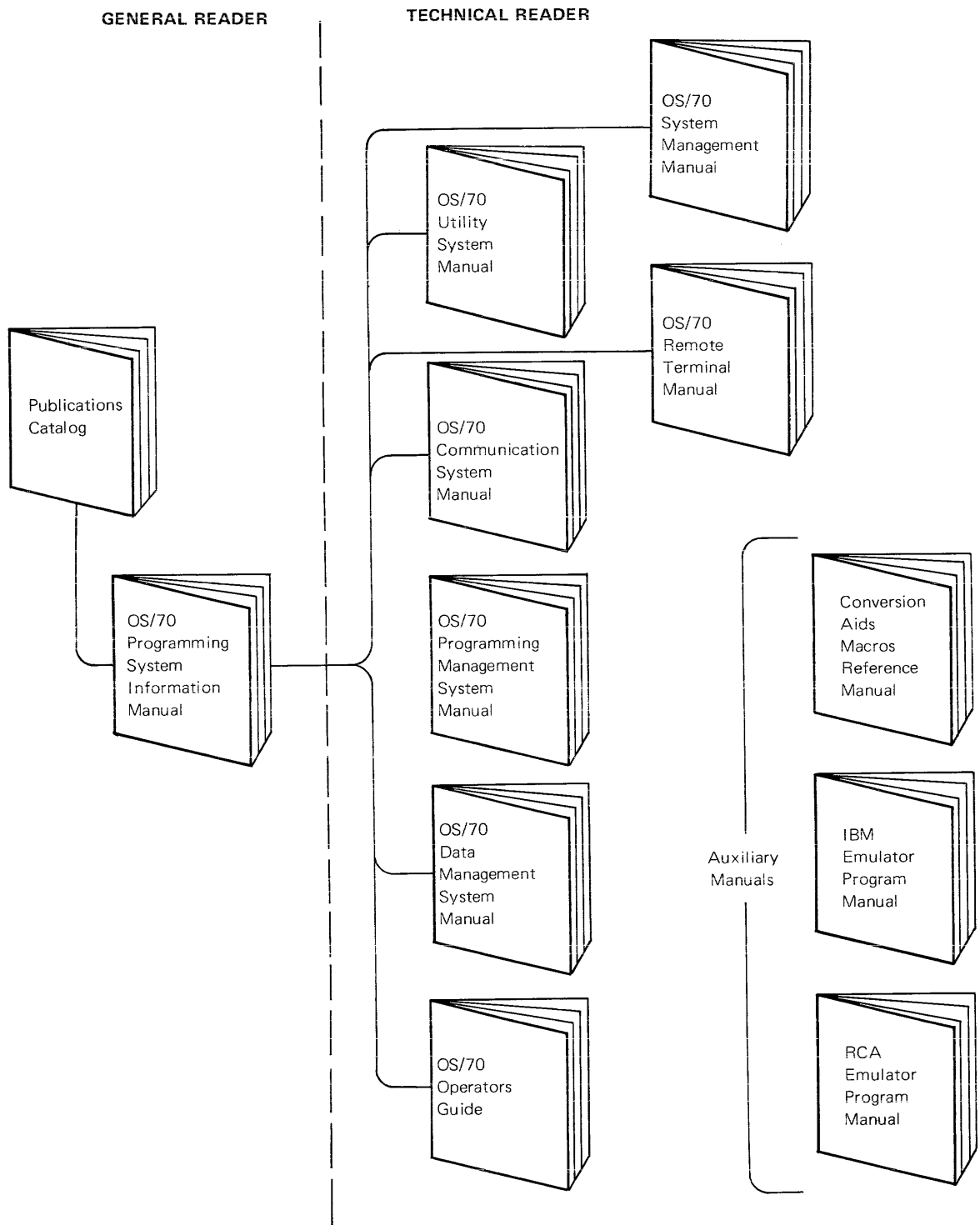

FIGURE 3-2. PUBLICATIONS PLAN FOR OS/70

Virtual Memory Operating System (VMOS)

INTRODUCTION

The Virtual Memory Operating System (VMOS) for the RCA 3 and RCA 7 is a multilevel, multiaccess control system for local and remote batch processing, interactive processing and communications oriented functions. VMOS provides convenient access to the computer for many simultaneous users and allows their dynamic interaction with executing programs. VMOS features efficient batch processing in a multiprogramming, random-access environment; rapid response for interactive remote terminal users as well as remote job entry; and a wide variety of communications activity.

VMOS offers object-level compatibility with most user programs prepared under other RCA Operating Systems such as TSOS, TOS, and TDOS.

The equipment configuration required to support the minimum VMOS level of facilities is shown in the following list:

| <u>Model or Feature No.</u> | <u>Quantity</u> | <u>Description</u> |
|---------------------------------|-----------------|--|
| RCA 3 | 1 | Processor includes: Multiplexor channel Memory Protect Elapsed Time Clock |
| 8000-013 | 1 | 131,072 Bytes (Main Memory) |
| 5040-003 | 1 | Selector Channels – 2 |
| 8097-020 | 1 | Operator Console |
| 8590-002 | 1 | Direct Access Storage System (58,352,000 Bytes) |
| 8472-108 | 1 | Tape Controller – Single Channel |
| 8432-001 | 1 | Magnetic Tape – 30KB |
| 8232 | 1 | Card Reader |
| 8234-010 | 1 | Card Punch |
| 8242-030 | 1 | Printer (625 Lines Per Minute) |

| | | |
|----------|---|---|
| 8560-005 | 1 | Virtual Memory Storage System (Includes 512-Page Magnetic Drum, Random Access Controller, and I/O attachment) |
| 8668-011 | 1 | Communications Controller Multichannel (CCM) – 16 lines each. (Required for remote access. One or more associated buffers must also be included.) |

A large equipment configuration for a large-scale VMOS application on the RCA 7 is shown in the following list:

| <u>Model or Feature No.</u> | <u>Quantity</u> | <u>Description</u> |
|-----------------------------|-----------------|--|
| RCA 7 | 1 | Processor includes: |
| | 1 | Two selector channels |
| | | Multiplexor channel |
| | | Memory Protect |
| | | Elapsed Time clock |
| 8000-015 | 4 | 1,048,576 Bytes Main Memory |
| 5058-007 | 1 | Selector Channel - 4 Additional |
| 8097-020 | 1 | Console |
| 8560-011 | 2 | Virtual Memory Storage Systems (includes 1600 Page Magnetic Drum, Random Access Controllers, I/O Attachments) |
| 8590-008 | 2 | Direct Access Storage Systems (466 Million Bytes each) |
| 8478-208 | 1 | Tape Controller - Dual Channel |
| 8459 | 8 | Magnetic Tape Units (320 KB) |
| 8237-010 | 2 | Card Reader |
| 8234-010 | 1 | Card Punch |
| 8244-200 | 3 | Printer (train) (1200 Lines Per Minute) |
| 8668-021 | 2 | Communications Controller Multichannel (CCM) – 32 lines each. (Required for remote access. One or more associated buffers must also be included for each CCM.) |

Section 1: VMOS PROGRAM ORGANIZATION

GENERAL

Irrespective of the level of implementation, VMOS is structured into an integrated grouping of components that offer the user a completely adaptable system to handle the wide variety of computing applications he may have. These components are grouped as follows:

1. Control Components
2. Interactive Language Facilities
3. Batch Processing Facilities
4. Service Routines
5. Application Programs
6. Communications Facilities

VMOS CONTROL COMPONENTS

The VMOS Control Components consist of the Executive, Data Management, and Communications.

The Executive component controls all job scheduling, assuring a continuous flow of jobs through the system; task scheduling and management, supervising each unit of work on a sequential or priority basis; resource scheduling and management, controlling the use of real and virtual memory, time-sharing and paging algorithms, multiprogramming and input/output activity; as well as a wide variety of communications functions.

Data management is a comprehensive system for file manipulation. In VMOS, files are:

1. Data (user program input/output).
2. Language statements that comprise a source program.
3. Object programs.

VMOS file manipulation is divided into two categories: 1) file cataloging and management, and 2) user program input/output activity. File cataloging and management identifies, stores, retrieves, and shares files. It also copies and erases them. User program input/output activity is the traditional open/get/close processing. File security is guaranteed by the use of read and write passwords and a share option that can be specified when the owner of a file catalogs it.

Files reside on public or private volumes. A public volume is mounted on a direct-access device during the entire period of system operation. It can be used by many tasks concurrently. A private volume need be mounted only when a task refers to it.

Various Data Management commands provide services for allocating space on volumes, for cataloging, and for defining files.

There are several file-access methods for sequential and index sequential logical-level record processing and for physical-level input/output activity.

The Communications component provides the broad sophisticated functions associated with a medium or medium-to-large communications system while concurrently supporting interactive and remote job entry users. Communications coupled with Data Management offers transaction-oriented processing for a fully integrated information management system.

The total Control System of VMOS provides a unified interface to each of its components and presents an integrated user interface for all work to be performed on the system.

INTERACTIVE LANGUAGE FACILITIES

The Interactive Language Facilities of VMOS allow the conversational user to construct a variety of programs, to run and debug these programs, and to modify and store these programs, all from a remote terminal. The many interactive language facilities available to the user include:

1. Interactive Extended BASIC.
2. Interactive FORTRAN IV (IFOR).
3. File Editor (EDIT).
4. Interactive Debugging Aids (IDA).
5. COBOL Syntax Checker (COBSYN).
6. COBOL Program Preparation System.
7. Desk Calculator (CALC).
8. Princeton Interactive FORTRAN (PIFOR).

These language facilities allow the user line-at-a-time diagnostic capabilities and problem-solving controls that reduce effectively program turnaround time and yield faster results to programming problems.

Interactive Extended BASIC

The interactive BASIC language is an elementary algebraic language which is easy to learn and use and can be applied to most scientific and business problems. The language includes arithmetic statements, matrix operations, identifier statements, simplified I/O facilities, logic statements, and loop and subroutine facilities.

The extended BASIC compiler offers both editing functions and debugging aids in addition to the language components.

Interactive FORTRAN IV

The interactive FORTRAN IV (IFOR) compiler is an interpretive system which allows the remote terminal user to combine program preparation and execution by interacting with the conversational FORTRAN IV compiler. The source program is compiled one statement at a time and is executed interpretively.

The interactive FORTRAN IV system includes a full FORTRAN IV language, an integrated syntax-checker, text-editing facilities, powerful debugging statements, and immediate execution options.

File Editor

The VMOS File Editor provides for creating, modifying, and displaying files. The editor may be used in the nonconversational mode, but it is intended primarily for use from a terminal so that the user may control processing command by command. The editing commands may come from the system input device or from a program. Responses or messages from the editor will be returned to the system output device or to the program accordingly. The format for commands and allied messages is uniform and independent of the source.

The editor will manipulate either lined (principal) files or unlined (secondary) files; its full power, however, is available only with lined files. An unlined file is a sequential file of logical records accessed serially, that is, having processed one record the user may only process the next. The user may generate such a file one record at a time, or may add records at the end. Provision is made for inserting secondary information to a line file and to write all or part of a principal file to an unlined file.

The File Editor commands are classified as control commands, line moving commands, line content commands, mode setting commands, or conditional commands.

IDA (Interactive Debugging Aid)

The Interactive Debugging Aid (IDA) is a program-checkout language. The IDA statements are a subset of the control language system. IDA allows a programmer to monitor the control and computational functions of a program during object execution. IDA need not be used interactively and its facilities are available to both Class I and Class II programs.

IDA commands can be combined into statements that request immediate execution of one or more commands, or request deferred execution.

COBOL Syntax Checker (COBSYN)

The COBOL Syntax Checker (COBSYN) is a conversational program that allows the user, operating a remote terminal, to enter a COBOL source program, to find any errors in its syntax, and to correct these errors.

Alternatively, the user can elect to present his source program to COBSYN in a pre-stored source file, created by use of the File Editor.

After correcting errors in the source COBOL program, the user can call on the COBOL compiler to create an executable program.

COBOL Diagnostic Edit (CODE)

The COBOL Program Preparation System combines certain features of the COBOL Syntax Checker, File Editor, and Interactive Debugging Aids to allow the user to create, modify, check, compile, load, execute and debug his COBOL programs with a single comprehensive interactive language. After completion, the user can store and catalog his tested program for productive use. CODE also allows users to combine parts of other COBOL programs into a new program with a minimum of effort.

Desk Calculator

The Desk Calculator is a conversational program that simulates a commercial desk calculator by use of a remote terminal. Numeric quantities may be entered and displayed in either fixed or floating point. The functions provided are: Add, Subtract, Divide, Square Root, Powers, Exponential, Trigonometric and Hyperbolic functions, and Logarithms (Natural and Common). Intermediate results are retained in 16 accumulators.

Section 2: BATCH PROCESSING FACILITIES

BATCH PROCESSING

The VMOS Batch Processing Facilities use efficient multiprogramming techniques in a user-controlled priority environment to offer remote batch processing and a unified group of industry-standard source language processors.

REMOTE BATCH PROCESSOR

The VMOS Remote Batch Processor permits the user to enter batch jobs into the VMOS system from his terminal and to monitor, cancel, pause the job, or to redirect the output of the finished job at termination. The remote user then has the same facilities as the on-site user who would enter batch jobs by way of an RCARD command issued by the system console operator.

The Remote Batch Processing System supports the RCA 8740 Data Terminal System as well as the UNIVAC DCT-2000.

NON-INTERACTIVE SOURCE LANGUAGE PROCESSORS

The VMOS assembler, ASA FORTRAN IV optimizing compiler, and ANSI COBOL Level D compiler are random-access oriented, efficient background language systems that allow the user to create pageable or non-pageable programs and to interactively access the post assembly/compilation diagnostic information produced by these processors. The Report Program Generator (RPG) also allows the user to produce pageable object report programs from a simple source language input.

Macro-Assembly System

The VMOS Macro-Assembler is a machine-oriented, symbolic programming language organized to accommodate the VMOS remote terminal user. Macro-assembler programs use the Data Management System for efficient I/O and provide functions for assisting the programs. The VMOS Macro-Assembler produces pageable object programs.

The VMOS Assembler provides all the language elements found in the TOS/TDOS Macro-Assembler and in addition includes:

1. A greater flexibility in naming macro-set symbols.
2. Availability of type and length attributes at source code generation time.
3. More conditional Assembly Statements.
4. An increased number of macro operands.

FORTRAN IV Batch Compiler

The FORTRAN IV Batch Compiler translates source programs into Class II object programs. The source language is the full FORTRAN IV and includes all of ASA standard FORTRAN while adding many powerful features such as generalized-type statements, mixed-mode arithmetic, literal constants without character counting, FORMAT-column control, and NAMELIST.

The compiler provides the ability to compile a program and execute or to chain-compile several programs.

COBOL Compiler

The COBOL Compiler translates source programs written in the COBOL language into object modules. As a by-product of the translation, the compiler produces listings for use in debugging, maintaining, and documenting the source and object programs. These listings are queued to the background utility operations which are subsequently processed by the system's spooling functions.

In addition to all previous COBOL compiler features, the language is extended to include:

1. The ability to specify alternate input files to access the source program from user direct access storage.
2. The ability to specify that object modules be written to a direct access file.
3. The generation of pageable object modules.
4. The facility to direct limited error printouts to the user at a terminal rather than to the system's spooling functions.

Report Program Generator

The Report Program Generator produces an object report program from source language. Common report features such as input data selection, editing, calculation, summarizing, control breaks, and file updating are provided by the generator.

The source program is the input to the Report Program Generator. The source language consists of six types of statements which are called the input, output, calculation, line counter, file, and file extensions specifications. These specifications provide information on the input/output data, editing, and calculations to be performed, and input/output devices required by the object program.

RPG provides the capability of handling input/output files on a direct-access storage device.

GENERAL

The VMOS Service Routines provide a broad category of RCA-supplied functions to aid the user in monitoring his system and to interface with its standards. The following descriptions provide an overview of the services performed.

DISPLAY PROGRAM

The Display Program is a sharable, interactive program providing statistical data reflecting the performance of the system. The program is initiated from a video terminal. The activity statistics provided are: central processor unit usage, paging rate, I/O rate, average response time, number of active tasks, and various resource statistics.

DUMP CHARTING PROGRAMS

The VMOS Dump Charting Programs produce and aid in the analysis of a VMOS dump. Their output is a listing showing the status of each task at the time of the dump, followed by an expanded and explanatory trace table.

HARDWARE CHECK ROUTINES

The Virtual Memory Operating System contains several routines for equipment check-out. These are:

1. Basic Processor Unit Check Routine – This routine detects arithmetic instruction malfunctions under multiprogramming, time-shared conditions.
2. Disc Hardware Check Routine – This is a multipurpose program intended for use by hardware maintenance personnel. It tests the disc storage unit without resorting to system shutdown. In addition, the program provides troubleshooting aids and confidence tests for the disc and related hardware.
3. Tape Unit Hardware Check Routine – This routine encompasses the functions for tape unit testing and diagnostics.
4. Unit Record Hardware Check Routine – This routine tests device reliability and error detection capabilities of various unit record peripherals attached to the processors.

LINKAGE EDITOR

This program is called to produce load modules from the object modules produced by the language processors. In a time sharing environment, several remotely located programmers may often work together to develop a single major program. The Linkage Editor can link their object modules that have been compiled or assembled separately to produce a single loadable program.

The Linkage Editor also: links modules for program overlays, obtains and loads modules from the object module library, allocates record space for the internal symbol dictionary used with debugging aids, prepares program load maps, furnishes diagnostic messages and lists of unresolved references, and converts object modules produced by the Assembler into load modules.

DYNAMIC LINKING LOADER

The Dynamic Linking Loader allows loading of programs that have not been bound by the Linkage Editor. This program aids the user who has relatively few modules so that he is not penalized with the memory requirements of the more sophisticated Linkage Editor.

SORT/MERGE

VMOS includes a standard Sort/Merge Generator for tape and disc. The Sort/Merge can be called and scheduled for execution from remote terminals. The Sort/Merge Generator creates tailored Sort/Merge programs based on user-supplied parameters and allows for inclusion of own coding routines.

LIBRARY ROUTINES

These routines create and maintain source libraries, macro libraries, and object module libraries. The routines also maintain the directory that is included in the library to speed searches made by the Linkage Editor and Dynamic Linking Loader.

PERIPHERAL CONVERSION ROUTINES

VMOS supports a full line of peripheral conversion routines to enable programmers to convert data from one input/output medium to another.

RECOVERY/RESTART FACILITIES

RCA 3 and 7 Series systems are designed for full time operation. In the event of most failures, the operating system automatically, without interruption of user's processing, reconfigures itself around the failed component. In the event of a power failure VMOS executes an orderly shutdown. The shutdown is designed so that the restart procedure permits interactive users, logged on at the time of shutdown, to log-on again and resume processing.

SYSTEM MAINTENANCE ROUTINES

These routines update the system at an installation as modifications and enhancements are provided by RCA.

OUTPUT ROUTINES

The output routines produce output as desired by the user. Specific pages of memory may be displayed, files may be printed upon request and random access devices edited as required.

Section 4: COMMUNICATIONS FACILITIES

GENERAL

Communications facilities range from the more basic support capabilities of VMOS as implemented on the RCA 3 to the broad and sophisticated functions of VMOS as implemented on the RCA 7. These facilities, available in varying degrees dependent on configuration, are as follows:

Inquiry Response

Interactive Applications

Remote Job Entry

Data Collection

Message switching – through user program use of System facilities.

DEVICES SUPPORTED

The devices supported by the VMOS Communications system, dependent on configurations, are as follows:

RCA 8668 CCM, Models 1 and 2

RCA 8656 Single Channel Controller

RCA 8626 Data Exchange Control (DXC)

Models 33, 35, and 37 Teletype

3-Row Telex

4-Row TWX

IBM 2741 Terminal

IBM 1050 Terminal

Univac DCT–2000 Terminal

RCA 8740 Data Terminal

Dataspeed 2

RCA 87522 Video Data Terminal with or without 8755 Switch AT&T Video Terminal (developed by Teletype Corp.)

RCA Modular Video Data System

TERMINAL/LINE FUNCTIONS

The terminal and line functions supported by the VMOS Communications System, dependent on configuration, are as follows:

Private (Leased) Line Support with Point-to-Point Operation

Private (Leased) Line Support with Polling for Multistation Operation.

Private (Leased) Line Support with Selective Calling for Multistation Operation.

Manual Dial Operation on the Switched Network where the terminal dials the processor in order to send a message. (This form of operation is known as the attended mode.)

Auto-Dial Operation on the Switched Network where the processor dials the terminal in order to solicit input or to transmit data. (This form of operation is known as the unattended mode).

Half-Duplex and Full-Duplex Support.

Polling and Selective Calling Priorities

Terminal Answer Back to Processor

Processor Answer Back to Terminal

Support of 'Break' capability

Section 5: VMOS APPLICATION PROGRAMS

GENERAL

RCA VMOS offers the user an open-ended series of application programs designed for specific functions that require only input directives from the user. Among these are the Automatic Text Formatting System (AUTOFORM) and a comprehensive group of industry-oriented application programs. The latter are described in Part 5 of this manual. In addition, it is easy for the user to add his own application programs to the system.

AUTOFORM

The Automatic Text Formatting System (AUTOFORM) provides a convenient method for producing, reproducing, and updating technical and other documentation. AUTOFORM obviates much of the checking and rechecking that normally accompanies the typing and retyping during documentation development and updating. Material may be entered into the system by a typist who uses a remote terminal to type the data and enter the control characters which are used by the system. The system provides great flexibility in formatting the material. Changes, additions, and deletions can be readily made and checked, with the assurance that only the area where revision is desired will be changed and the remaining material will not be affected.

Section 6: VMOS SUMMARY

The RCA Virtual Memory Operating System offers many combinations of programming and computing facilities on a wide range of system configurations. At the lower levels of implementation, VMOS for the RCA 3 represents an improved version of the RCA Spectra 70/46 Time Sharing Operating System (TSOS) with more processing power and new levels of price/performance for local batch, remote batch, and interactive workloads under control of a single operating system.

For performance beyond that of the RCA 3, VMOS, as implemented on the RCA 7, offers a highly integrated systems capability for transaction-oriented processing with expanded communications facilities in an 8-million byte virtual memory environment. Multiprocessing with a communications front end processor plus a communications system administrator command language function allow the user to meet both his near-term and long-run information processing requirements for the decade of the 70's.

Section 7: PUBLICATIONS PLAN FOR THE VIRTUAL MEMORY OPERATING SYSTEM (VMOS)

Publications for the Virtual Memory Operating Systems are shown in figure 4-1. Document ordering numbers will be supplied as documents become available. The documents represented in figure 4-1 are described briefly in this section.

All documents in the VMOS publication plan are designed for specific readers. These readers fall into two general categories:

1. The general reader: all users, but specifically corporate and information processing management.
2. Technical readers: operators, programmers, system controllers, remote terminal users, information processing specialists, and systems programmers.

The publication intended as the VMOS overview document for management personnel is the VMOS Programming System Information Manual. This manual is also intended as the introductory and base document for use by all technical readers, as well. In addition to an overview of the VMOS, it contains a detailed description of the other documents that describe the system and a definition of the reader classes for whom the various documents are designed.

The publications for the technical readers are described below:

The VMOS Installation Management Manual describes the responsibilities of and the facilities available to the manager of an installation using the Virtual Memory Operating System. It describes the use of the system commands available to the installation manager, the use of procedure files, the use of the utility functions available to him, his responses to the messages that the system sends to him, and system generation. This manual is written for the operations manager (sometimes called the system controller) of an installation using the virtual memory operating system.

The VMOS System Operation Manual describes the software operating procedures required of the system operator at an installation using the Virtual Memory Operating System. The manual contains start-up, operating, and shutdown procedures. It gives a description of the use of the commands available to the operator and states the operating procedure for those utility routines that are necessarily performed by the operator. System typeouts and operator responses are listed. This manual is written for the operator(s) of the computer console and the related peripheral equipment.

GENERAL READER

TECHNICAL READER

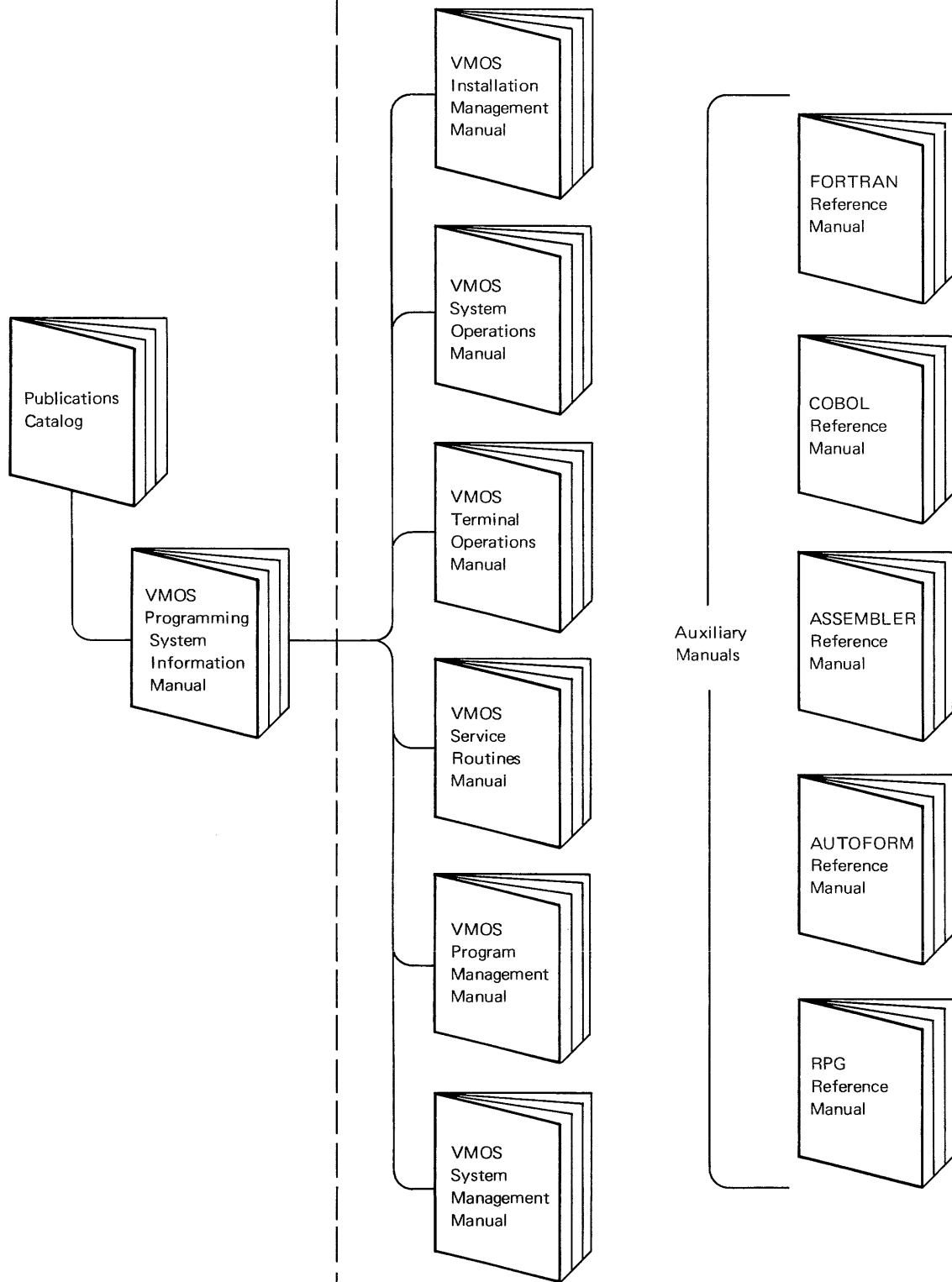

FIGURE 4-1. PUBLICATIONS PLAN FOR VIRTUAL MEMORY OPERATING SYSTEM (VMOS)

The VMOS Service Routines Manual describes the use of the programming support routines and installation support routines that are contained in the Virtual Memory Operating System. The functions performed by these routines include library maintenance, system maintenance, device-to-device utilities, sort/merge, and miscellaneous output functions. This manual is written for the experienced background user or the experienced conversational user of those information processing routines commonly referred to as utility routines.

The VMOS Terminal Operations Manual describes and gives operating instructions for the terminals supported by the Virtual Memory Operating System. Terminals are communications devices remote to the processor and connected to it by way of telephone lines, a communications controller, and associated communications equipment. This manual describes the equipment, making use of photographs and line drawings, and gives step-by-step instructions on the use of the equipment. It also includes all the messages that the system can type to a terminal and suggested responses to them. This manual is written for the conversational user of the VMOS.

The VMOS Program Management Manual provides a complete reference text for program preparation using the Virtual Memory Operation System. The entire programming process for COBOL, FORTRAN, and the Assembler is described — source program input, compilation, post-compilation diagnostics, debugging, execution, and library maintenance. The facilities available to the programmer for data/file management are described. The BASIC and Desk Calculator facilities are described. This manual is written for the experienced background or interactive programmer using the programming languages supported by the Virtual Memory Operating System.

The VMOS System Management Manual provides a complete reference text for the use of the task management and the data management systems of the Virtual Memory Operating System. The use of task management commands, task management macros, procedure files, the message processing facility, file management commands, file management macros, data access methods, and device management facilities are described. Formats of modules and libraries are provided. This manual is written for the experienced conversational and background users of the VMOS to aid them in system planning and control and task and data/file management.

Industry Applications

INTRODUCTION

RCA 2, RCA 3, RCA 6, and RCA 7 Computers are designed specifically to meet your requirements for a new level of technical advances that are better and easier to use.

The new computers offer better performance, reliability, and cost – to provide you with a logical way to grow. Now you can move up realistically without being forced to buy a computer with more power than you can use, just to get the extra memory capacity you need for your new applications, for about what you're spending now.

The RCA 2, RCA 3, RCA 6, and RCA 7 are built to a memory-oriented philosophy, resulting in larger memories and greater computer efficiency than ever before, with new approaches to real memory, with trend-setting virtual memory, and with dual processors switchable memory.

Conversion will be easy and completed on time. RCA has a guaranteed conversion plan to insure that your essential computer operations will not be disrupted. In addition, you can have bundled or unbundled systems support.

This part of the manual describes some of the existing applications that can be improved by using the RCA 2, RCA 3, RCA 6, and RCA 7 Computers.

RCA BANKING APPLICATIONS

A number of banking business applications programs will be provided by RCA and will be implemented under the new RCA Series of computer systems. They are described below.

Demand Deposit Accounting

This application program permits any bank's demand deposit accounting system to be automated. The system produces a variety of timely reports to convey the activity and status of accounts under the demand deposit service.

Proof and Transit Accounting

This application program minimizes the item handling costs, and also minimizes the time between the presentation of a check for payment and the actual collection of funds at a correspondent bank.

Savings Accounting

This application program was developed after thorough research of management attitudes on savings account relationships. Saving activities, methods of interest calculation, and payment of dividends are accommodated within a multibank processing environment. The system produces comprehensive and pertinent analytical reports which are of exceptional value in the management of savings account activity.

Time Deposit Accounting

This application program handles all types of savings, clubs, and certificates of deposit, for both passbook and statement accounting. Special features of the system provide for multibank processing, customer analysis, and optional report formats. Tax reports and all combinations of interest calculation and accruals are processed by the system.

Installment Loan Accounting

This application program provides computer system handling of the installment lending function. The system provides senior management with the reports required to supervise the lending activities, and provides operating personnel with the detailed reports and documentation needed for daily portfolio servicing and control.

Corporate Trust Accounting

This application program administers stockholder accounting, particularly with reference to: cash dividends, stock dividends, stock transfers, proxy listings, and tax reporting. The system can be used either by a corporation handling its own records, or by a transfer agent (bank) maintaining records for several corporations.

Distribution Accounting and Control System

This application program satisfies the administrative accounting demands of many medium sized businesses. Processing is provided for: order entry, inventory control, sales analysis, accounts receivable, accounts payable, and general financial ledger.

Payroll System

This application program provides a method for maximum capability payroll automation. The system includes the major functions common to all payrolls, and many functions which can be tailored to a particular application.

Personnel Data System

This application program handles all normal corporate personnel records functions. Most of the input transactions and the reports are general in nature and applicable to most personnel data situations. A few, such as a retirement plan, are geared to a particular application, but may be modified to suit general needs.

Alpha Index

This application program has been developed to maintain and perform searches on an alphabetically-indexed master file. Any user who has a need to find customers with one or more account numbers, policy numbers, or other reference data may use this program to correlate his files.

NEW CONCEPTS IN COMPUTER BANKING APPLICATIONS

New concepts in Banking will lead to a wider use of computers in that industry: several of these are described below. The new RCA Series of computers provide the banking industry with greater capabilities to implement such new systems.

Personal Trust

Personal Trust automation has lagged, probably because of the emphasis on other more basic banking applications such as Demand Deposit and Proof and Transit. Also, the area of personal trust offers many problems in automation because of the variety of operations and interrelationships involved. The new RCA 3 and RCA 7 Computers with their combination of time-sharing and batch processing facilities accommodate the need for handling daily remote inquiries and security transactions, as well as volume operations such as customer statements and reports. In order to obtain the greatest benefits from a computerized personal trust application, on-line inquiry and response is a must. A capability like this provides the trust officer, as well as the investment man, with immediate access to the information needed for informed decisions. Through concurrent access to the data base, either of these decision makers can approach his task as though the entire computer facility is at his command.

Another important reason for an on-line system is that it will provide, in addition to access to timely information, adequate computer power for use of such management tools as operations research techniques. A personal trust accounting system could then be a combination of an on-line accounting system and a management information system. In addition to the normal additions, alterations, deletions, and inquiries to the data base, a personal trust system should be able to answer complex questions that will increase as the system grows. This includes full utilization of financial analysis programs for portfolio management. A person making an inquiry to the system may want to ask for any number of analysis programs to process the data involved. He might want to initiate an entirely new algorithm for a specific calculation. A system must be able to handle many different types of such inquiries that would be generated by trust administrators, security analysis, vault personnel, tax specialists, auditors, and others.

Central Information File

The RCA 2, RCA 3, RCA 6, and RCA 7 Computers meet the needs of the various organizational and management levels of a bank. For this reason, the Central Information File Concept, applicable on the RCA 2, RCA 3, RCA 6, and RCA 7, employs a hierarchy of storage systems. It could encompass two general categories — customer information and bank management information. The customer information file would include all applications, with the addition of an alpha file that links all of a customer's account. The management file would contain the business accounting functions such as payroll, general ledger, and cost accounting. Using RCA Video Data Terminals, bank officials could inquire into the status of a customer to determine his total relationship to the bank, including the profitability of the account. With the same terminal, a manager may inquire into the profitability of a department and perhaps request a detailed printed copy. Such applications often include sensitive information. An RCA Video Data Terminal would allow the user to eliminate both the display and printing of confidential information while entering data into the data bank.

Credit Cards

Separate bank credit cards are being merged into nationwide networks of "interchangeable" card plans, so that a customer can use a card from his own bank almost anywhere. These new interchange plans are feasible with RCA Computers featuring data banks that can easily handle the huge volume of transactions and master files.

GENERAL

Characteristics of insurance company operations are the detailed individual policyholder records in tremendous "people files," associated agency files, and voluminous statistical and other technical applications. The new RCA 2, RCA 3, RCA 6, and RCA 7 Computers answer these needs with data banks that can both accommodate the volumes of information needed and pinpoint facts precisely on demand. Insurance information is requested from many points and must be disseminated to many points. RCA Computers answer this need through their facility with communications.

DATA BASE MAINTENANCE

On-line files and immediate access to all insurance processing routines allow for efficient maintenance of the total data base while simultaneously processing the other daily insurance activities. Your transactions generate their own processing needs to serve your business.

UNDERWRITING

Through the RCA Video Data Terminal, pre-formatted plans can be retrieved and filled in with variable input information, and basic underwriting and detail plan requirements can be verified immediately upon input.

RATING

While the ability to have all basic plans, riders, and endorsements available on-line to the user at all times, rate calculation or rate verification can be accomplished immediately during the application input cycle.

POLICY ISSUE

Policy issue can be completely implemented, including printing of the declaration page or policy face sheet, the creating of the data base records, and generation of the necessary statistical records.

POLICY INQUIRY

Immediate access to the various files for general status information, such as paid-to-dates, loan value, and types of coverage, is available at all authorized local and remote operating points.

GENERAL ACCOUNTING

A data base including a complete chart of accounts permits immediate updating of all financial activities and provides immediate access to key data for management review. Today's actions are available today.

SALES

Development of policy illustrations from terminals in each sales office and the ability to prepare on-line a complete estate plan, or to perform complex insurance rating tasks, enables agents to service policyholders faster and increase their own sale productivity and earnings.

GROUP INSURANCE, GROUP ANNUITIES, AND PENSION TRUST

Fast and interactive processing of group insurance and group annuity or pension trust proposals enables group representatives to give better, faster, and more flexible service to agents and brokers. On-line maintenance of detail and cumulative statistical data reduces the task of performing complex retention quotations.

CLAIM PROCESSING

With coverage, endorsements, limits, limiting riders, and prior claim history immediately available, fast and efficient services and confirmation of justified claims is now a reality.

ALPHA-INDEX

Quick cross-reference to obtain a policy number or additional policy numbers held by an individual are easily effected with the automation of the alpha-index file. RCA's Alpha-Index Program Package offers easy development of this function on your computer system.

ACTUARIAL PROCESSING

With all insurance files on line and with the interactive facilities of the RCA 3, and RCA 7 Computers, actuaries are greatly aided in such functions as new plan determination, reserve estimates, mortality and morbidity studies, and premium and loss studies at the convenience of your actuary.

GENERAL

With the trend toward on-line customer service and inquiry/response, vast amounts of data must not only be sifted and sorted economically and swiftly on a cyclical basis, but individual records must also be pinpointed instantly, and information communicated back to points of use in main, district, or branch offices. RCA 2, RCA 3, RCA 6, and RCA 7 Computers answer these needs with data banks offering a broad range of speed and capacity, implemented by software combining highly efficient batch and direct-access processing, and complemented by versatile communications facilities.

RCA computer multiprogramming – the ability to run a number of different programs concurrently – is especially useful for the wide range of utility information operations. Besides billing and accounting, the same system will handle customer service and inquiries, engineering, inventory management, operations, personnel, and payroll. Just as the utility industry has responded to the need for assured system reliability and freedom from service interruptions, RCA has addressed the same problem. The RCA 2, RCA 3, RCA 6, and RCA 7 feature improved-computer reliability of their own, by allowing for system maintenance to be performed while the computer is in use.

Ultimately, RCA Computers allow evolution to an integrated system for management information; in effect, a data reporting system for top, middle, and supervisory levels of management. They provide current operating data, as well as facts to help meet future growth requirements.

CUSTOMER SERVICE – ORDER ENTRY AND INQUIRY

RCA computer systems for customer inquiries and service calls allow immediate response to customer calls through the use of RCA Video Data Terminals. Typical customer service applications include:

1. Handling inquiries regarding billing and accounts receivable.
2. Initiating or terminating customer services.
3. Improving customer relations.
4. Relaying entered orders to remote work locations.
5. Providing current and accurate credit controls.

ENGINEERING

Available with RCA computers are programs to assist the utility engineers in analyzing the reliability of their network:

1. Load Flow Analysis programs
2. Fault Analysis programs
3. Transient Stability programs

In addition, RCA computers provide engineers with the capability to analyze nuclear fuel consumption and study the effects of thermal and air pollution.

INVENTORY MANAGEMENT

RCA computers permit utilities to benefit from effective control of material supplies costs. Depending upon the sophistication of the system, users can obtain:

1. Interface with work order and plant accounting
2. Automatic listings of material to be purchased
3. Material picking lists produced from a Bill of Material explosion system
4. Implementation of a Compatible Units System
5. Instant access to location of inventory

WORK ORDER ACCOUNTING

RCA computers have assisted utilities in developing general operating systems for their service areas that:

1. Report crew and material costs by job category
2. Establish crew schedules and work standards
3. Provide meaningful operating data for cost control purposes

PAYROLL AND PERSONNEL

Programs written and supplied by RCA answer the need for accurate and available personnel and payroll records and reports.

GENERAL

Many computer applications use the same data, and when processed on an individual basis, they result in a great deal of redundancy in data base and duplication in processing functions. The need is for a single integrated data base whereby each element of information is entered only once by the originator and completely processed and distributed throughout the data base file. There is also a need to update the data base file with transactions as they occur and provide all pertinent status information, either by inquiry or automatically, as changes take place. RCA 2, RCA 3, RCA 6, and RCA 7 Computers answer these needs by offering a highly versatile family of processors, complemented by a broad range of peripheral and direct access equipment, along with comprehensive communications facilities and terminals. This hardware is efficiently implemented by inclusive software which can perform both batch and on-line transaction processing in a multiprogramming environment.

Besides the normal batch-oriented accounting functions, RCA Computers are especially well suited to manage and operate a wide range of information systems. In the telephone industry these include Customer Service and related operations, Number Services functions, and Trunks and Special Services. As these systems are so large in scope, they must be phased in, converting and implementing various portions over a period of time. RCA Computers are designed to allow for the evolution to a full integrated information system with the minimum initial expenditure, while providing for almost unlimited growth without the necessity of costly reprogramming.

CUSTOMER SERVICE

This is the largest of the three major telephone information systems. In implementing this system, RCA Computers provide the means by which all information pertaining to a customer can be accessed and updated anywhere within a geographical area. It will furnish current information to those who need to know and permit either centralization or decentralization of work forces. It will eliminate most of the paper records currently being used to administer the system. The major areas to be mechanized under this system are:

1. Customer billing and automatic treatment.
2. Toll and message unit rating and processing.
3. Production of reports relating to service and equipment.
4. Routing, switching and direct input of service order data.

5. Scheduling service calls.
6. Provide current and meaningful statistics as:
 - a. Work units performed.
 - b. Missed due dates.
 - c. Work loads for future dates.
 - d. Held service requests.
7. Assignment of customer facilities and equipment.
8. Maintenance of former customer records.
9. Generation of reports to aid in the management of the business, such as comparison of trends with forecasts.
10. Analysis of customer trouble.
11. Rate Quote

NUMBER SERVICES

This system consists of furnishing telephone number information to customers and telephone industry employees, both accurately and promptly. RCA Computers are already successfully performing the White Pages application within this system. In addition, RCA's leadership in the field of computer driven video-composition devices, which can set both pages of listings and line drawings, provides the opportunity and benefits of obtaining the entire product for the Number Services system from a single manufacturer. Applications which are part of the Number Services system are:

1. White-Page compilation and publishing.
2. Publication of daily additions to the latest White-Page book.
3. Yellow-Page compilation and publishing.
4. Administration of contracts pertaining to Yellow-Page advertising.
5. Directory delivery.
6. Intercept of calls made to disconnected numbers.

TRUNKS AND SPECIAL SERVICES

This system is responsible for estimating, engineering, and administering the trunk plant and facilities of a telephone company, and the special service circuits reserved for the exclusive use of a single customer. Like the system described above, this system also poses a similar record-keeping problem. However, the degree of program complexity is greater as a result of the many computations necessary to process a single transaction or to respond to a request. The RCA 6 and RCA 7 Computers meet these requirements with their large real or virtual memory systems and fast internal execution times.

TIME SHARING

Every telephone company spends a great deal of money on the construction of new telephone plants. Each company has the enormous task of identifying their current requirements as well as forecasting such requirements for future years. The administration and control of construction programs is one of the major areas where RCA time sharing computers can be applied in managing large expenditures.

The RCA 3 and RCA 7 Computers are not solely dedicated to time sharing but can process concurrently an application mix of different categories of jobs. These jobs can consist of local batch processing, remote batch processing, and conversational or interactive processing. Therefore, many of the applications listed above can be performed while time sharing programs, written in languages such as BASIC, FORTRAN, etc., are being executed. In many instances, virtual memory computers, although requiring additional hardware, will process large applications faster and more economically than real memory systems. To date, RCA is the only manufacturer of computer equipment to offer this choice.

GENERAL

The quest for information permeates manufacturing. Each product created is mirrored by facts put to use for planning and for control and for administrative operations – in factories, offices, laboratories, warehouses, and distribution centers often spanning the nation. Vast amounts of information have to be sifted, ordered, pinpointed, and communicated.

RCA computers allow the user to combine requirements – data banks, communications, and multiprogramming coupled with high speeds – making the RCA 2, RCA 3, RCA 6, and RCA 7 Computers powerful adjuncts in such functional areas as order processing, forecasting, inventory control, engineering data control, requirements generation, and production scheduling and control.

ORDER PROCESSING

RCA computers verify customer order data, determine customer credit acceptability, check inventory, determine shipment schedules, send order acknowledgements to customers, print shipping papers and invoice, and handle accounts-receivable accounting.

FORECASTING AND INVENTORY CONTROL

RCA application packages can be used to generate a forecast of demand for some future time period through an analysis of historical data. They assist management in analyzing such areas as demand patterns and market trends. They provide information for planning inventory levels; purchase and production requirements; and manpower, equipment, and facilities requirements. They assist management in maintaining inventories of manufactured items, components, and raw materials at levels sufficient to meet delivery requirements, while avoiding obsolescence and excessive carrying costs resulting from overstocking.

ENGINEERING DATA CONTROL

This RCA application package creates, maintains, and retrieves Bill of Material data. This data describes the relationship between finished products and their assembly specifications. Bill of Material and Where Used reports are prepared when desired. Bill of Material and Where Used reports provide management with tools that assist in determination of requirements and scheduling production.

This package offers the user the ability to interrelate up to nine data files and reorganize these with relative ease. They can fit within the communication-oriented environment that exists in many manufacturing companies.

REQUIREMENTS GENERATION

RCA computers establish the type and quantity of raw materials, component parts, subassemblies, and assemblies which will be needed at future time periods in the production calendar. By examining inventory conditions at each time period and indicating all shortage conditions, the computer system assures availability of the above items as required.

PRODUCTION SCHEDULING AND CONTROL

RCA computers assign start and due dates for all operations. They release shop orders to the floor early enough to meet scheduled start dates but late enough to minimize the risk of paperwork changes and control order progress by maintaining work in process records and generating priority-schedule work lists.

INFORMATION FOR AN INFORMED MANAGEMENT

RCA Computers assist in developing an information structure that helps management to make decisions. This information structure takes several forms such as:

1. Interaction of the control and operating loops that assure a continuity of progress
2. Identification of the operating causes which influence financial effects
3. Review of selected operating areas instantly and in microscopic detail when needed
4. Measurement of performance against established values.

GENERAL

RCA computers and systems are at work at all levels of federal, state, and local government.

LAW ENFORCEMENT

The RCA Computer System in Cincinnati provides instant access to police records by any of 38 agencies in the city and throughout Hamilton County – cutting costs for all.

The California Law Enforcement Telecommunications System (CLETS) links more than 450 California law enforcement agencies to computerized crime files in Sacramento and Washington, D.C.

RCA involvement in computerized law enforcement also extends to such cities as Buffalo, Charlotte, Fort Lauderdale, and Tampa providing:

1. Instant information on wanted persons, stolen or lost property, firearms, and stolen vehicles
2. Incident and accident reporting and analysis
4. Parking ticket and warrant control
5. Administrative processing

LEGISLATIVE AND ADMINISTRATIVE

Missouri, Illinois, Kansas, and Florida are using RCA multiprocessors in such response-oriented application areas as:

1. Income tax accounting
2. Motor vehicle registration
3. Payroll
4. Personnel administration
5. Property assessment
6. Sales and other tax accounting

HEALTH AND WELFARE

At the Florida Department of Health and Rehabilitative Services, RCA was intimately involved in developing and bringing on-line the nation's first statewide communications network for recipients and providers. Missouri's Department of Public Health and Welfare offers a Medicaid system in the "batch mode." The states of Michigan, Tennessee, and Pennsylvania as well as the New York City Department of Social Services, utilize RCA computers for such applications as:

1. Vital statistics
2. Case load accounting and analysis
3. Grant computation
4. Prescribing medicine
5. Food stamp distribution
6. Check writing

TRANSPORTATION

The task of planning highway and mass transit systems is awesome. With rapid shifts in the population and the ever-changing character of our urban centers, the need to use our present systems fully and to accurately predict future requirements is paramount. A comprehensive planning capability on the part of states and urban centers is necessary in order to obtain federal highway funds for use in the implementation of those plans.

Transportation Planning

RCA has a transportation planning system to aid transportation engineers and highway planners in making the decisions needed to use existing highway and mass transit networks to the fullest, and to plan for new roads or transit lines for the future.

Input to the system takes the form of trip survey data and highway network data based upon geographic zones. From this data, a model of an existing highway network can be created. Changes to the network or traffic volume or pattern can be simulated and the projected effect generated. The information thus obtained can aid in the design of transportation facilities to handle the needs of an expanding and increasingly mobile population.

Engineering

RCA's extensive scientific program library gives the civil engineer the tools necessary to accurately design highways and bridge structures with a minimum of effort. Use of RCA computers to do computations for the engineer will greatly increase his production by decreasing the time required to do tedious calculations. Major engineering systems available are:

ICES (Integrated Civil Engineering System)

BEST (Bridge Engineering Subsystem)

COGO (Coordinate Geometry System)

Earthwork Programs

Integrated Civil Engineering System (ICES)

ICES (Integrated Civil Engineering System) provides computational support to resolve civil engineering problems relating to structural analysis, roadbed analysis, table manipulation, project control, and network analysis.

Bridge Engineering Subsystem (BEST)

BEST is a Bridge Engineering Subsystem for Total Integrated Engineering System (TIES), a cooperative research and development project on various applications of computers and other advanced equipment to highway planning and design. BEST can produce complete and integrated designs for two types of structures – composite rolled beam and composite welded girder simple span bridges. Its modular design lends itself to the later inclusion of alternate bridge designs. BEST consists of nine macroprogram (MAP) modules that interact through a systems control to produce the desired bridge design.

Coordinate Geometry System (COGO)

COGO (the Coordinate Geometry System) is a problem-oriented computer language and programming system for solving problems in civil engineering. Many civil engineering problems involve locating the horizontal alignments and vertical profiles of highways. To use COGO a civil engineer translates his problem into an equivalent set of COGO commands.

Earthwork Programs

A series of programs has been developed to solve earthwork problems relating to highway construction. These programs deal with terrain edit, horizontal alignment, vertical alignment, template design, and areas and volumes. Supplementary programs may be developed for pavement edges, plotter applications, etc. The segmenting of systems will allow certain areas to stand alone for solution of specific problems that may arise during the design of a project. This approach would also allow the designer to check the various inputs and outputs at each stage of the development before proceeding to the next stage. The system is designed for uniformity of data from preliminary design studies to final design.

Administrative

In addition to the scientific use of RCA computers in the area of transportation, administrative applications are processed to meet total information processing needs.

A payroll application may be run by capturing all cost distribution data of projects before actually running the payroll application. In the field of transportation, payroll is often handled like a large construction company. Gross earnings are spread over certain projects. Employee working data is recorded so that the proper area can be charged for their services. Cost distribution data for contracts must be available for monthly federal reimbursements from the Bureau of Public Roads Federal Highway system.

Another administrative application is contracts. Bids for construction projects for a state are followed from original engineers estimate to awards to the payments of the contractors. Comparisons between the vendor and engineers estimates are produced.

Other administrative applications such as

inventory control

truck maintenance scheduling

inventory of tools and equipment

cost accounting

inventory of repair materials

are adaptable to computer implementation.

EMPLOYMENT SECURITY

Massachusetts and New Jersey Divisions of Employment Security use a communications-based Local Office On-Line Payments (LOOP) system which identifies the claimant, verifies his claim, and prints his check in under 30 seconds at any of the local offices.

Utah's Department of Employment Security, also utilizing RCA computer equipment, has an unemployment insurance system with inquiry/response capabilities and an automated job placement system with a "job bank" of all known job vacancies and an "individual bank" of job seekers. In Oregon, an Employment Security Accounting System and an Employment Security Automatic Reporting System are fully operational on RCA computers.

CITY-COUNTY

RCA Computers in Tampa, Memphis, Buffalo, Baltimore, and Cincinnati, and Orange County (Calif.) are successfully running such diverse applications as:

1. On-line inquiry/response water information networks
2. Municipal parking ticket systems

3. Uniform crime reporting
4. Payrolls
5. Budgeting accounting
6. Personnel
7. Traffic planning
8. Deed reporting
9. Vehicle invoicing
10. Planning, programming, and budgeting

GENERAL

Educational administrators are concerned with getting a maximum return from their investments in information-handling equipment, programming, and operations.

To help educators achieve this goal, RCA offers four new computers especially configured and programmed for full-time, full-load utilization in an educational environment . . . four systems designed to perform a broad variety of educational information-handling functions for both instructional and administrative users.

INSTRUCTIONAL SYSTEMS

RCA computers help usher in the vocational and basic academic skills responsive to the educational needs of today, among which computer-assisted instruction (CAI) has proved very successful.

Any major computer system with a few hours of uncommitted backup time – whether the system is owned by a bank, a telephone company, a university, or even industry – is a potential source of relatively low cost CAI service to schools in the vicinity. CAI goes far beyond the traditional textbook approach to instruction because, in addition to presenting information on a one-way basis, the RCA computer:

1. Accepts responses to questions
2. Performs an immediate analysis of the accuracy of the student's response making possible individualized instruction
3. Keeps each student and his teacher informed of the student's daily progress
4. Provides statistical reports on individual student performance, class performance, and problem reliability, for use in curriculum development and educational research

ADMINISTRATIVE EFFICIENCY

The RCA 2, RCA 3, RCA 6 and RCA 7 Computers can also be used for the following applications:

1. Student scheduling
2. Payroll

3. Test scoring and analysis
4. Pupil/personnel records
5. Accounting
6. Grade reporting
7. Utilization of space and equipment
8. Registration
9. On-time preparation of reports for state authorities and other reporting jurisdictions
10. Processing of student loans, grants, and fees

GENERAL

Existing applications within the medical field that can be improved by using the RCA 2, RCA 3, RCA 6, and RCA 7 Computers, in both the single and multiple hospital environment are described in this section.

The need for an expedient decision-making capability that is based on factual information has placed additional burdens on doctors and hospital administrators – decision makers who are attempting to provide effective medical services at minimum cost. The voluminous data to be considered, the complex interrelationship of the data itself, and the urgent need for high precision and expediency in responding to the complex problems facing today's hospitals are proving too much for manual methods of control. Hospitals need help that will provide them with the capability to readily obtain complete and timely information on a given patient, or on over-all operations necessary to effectively manage the hospital. As a result, more and more hospitals are turning to computers and computer technology to provide answers to medical problems in a timely and economical manner.

Using high internal processing speeds and virtually unlimited mass storage capability, the new RCA computers can process many different information-oriented requirements at the same time through multiprogramming.

APPLICATIONS

The speed and flexibility of the RCA 2, RCA 3, RCA 6, and RCA 7 Computers open more free time and program capacity for computer operation schedules. With multiprogramming, a number of routines within a given application may be performed simultaneously, or routines from more than one application may be run concurrently. The applications processing, executed mostly in a batch environment, can be run in the background, while an extensive communications network will allow for inquiry and response and substantial on-line data capture or file update. Applications include:

1. Patient Accounting
2. General Ledger Accounting
3. Accounts Payable
4. Payroll/Personnel
5. Inventory Control

6. Budgeting
7. Patient Scheduling and Resource Management
8. Preventative Maintenance
9. Medical Records Systems
10. Laboratory System
11. Pharmacy System
12. Dietary Management
13. Multiphasic Screening
14. Hospital Communication Network

INQUIRY/RESPONSE

The new RCA Computer Series is response-oriented. Combining a high-speed medical "information" bank with advanced communications and terminal facilities enables a doctor or a member of the hospital staff to get an immediate answer to questions relating to patients, administration, or finances. Such applications often include sensitive information. An RCA Video Data Terminal allows the user to eliminate both the display and printing of confidential information while entering data into a data bank.

Terminals with keyboards like a typewriter permit in-house or remote inquiry over telephone lines. The computer checks security, interprets the query, finds the information, formats a response and transmits the information for display to the user on a video screen or print-out on a teletype.

RCA on-line communication networks can effectively serve these areas within your hospital:

1. Business Office
2. Medical Records
3. Nursing Stations
4. Laboratories
5. Pharmacy
6. Dietary Department
7. Other Ancillary Departments

Section 9: MANAGEMENT SCIENCE

GENERAL

The emergence of third generation equipment with increased speed and storage capacity has brought us to the realization that management science applications are within reach of almost every computer user. In the past these applications were confined to the big and expensive machines.

Along with the advancement in equipment, the technology in management science has made significant advances to the point that it is an integral part of modern, efficient, organizational management.

Management science has a broad definition that includes mathematical, statistical, and operations research techniques that aid in effective decision making on the part of management.

Our purpose in developing and supporting these applications is aimed towards providing generalized programs as tools for solving varied business, engineering, and operations research problems.

Listed below are the packages available in the RCA 2, RCA 3, RCA 6, and RCA 7 Management Science Library:

LINEAR PROGRAMMING

These programs are used in the determination of optimum utilization of limited resources, whether these resources be raw materials, time, labor, or productive facilities.

Linear Programming has been used successfully in the solution of the following problems:

1. Feed Mix and Milling: Optimum blending of raw materials to provide least-cost product satisfying quality constraints.
2. Steel: Optimum blending of raw materials. Optimum cutting patterns. Optimum machine loading. Plant scheduling.
3. Glass: Optimum blending and scheduling.
4. Forest products: Optimum patterns and scheduling for paper and corrugated board. Transportation. Forest management.
5. Petroleum: Optimum product mix, crudes utilization, and production.

6. General manufacturing: Optimum utilization of raw materials, labor, productive facilities, storage facilities, and time. Warehouse and plant design. Transportation.

7. Agricultural: Land management. Optimum resource allocation.

STATISTICAL LIBRARY

This library is used for forecasting, quality control, curve fitting, reliability analysis, engineering design, processing simulation, analysis of data banks, and comparison of several vendors.

SSS/70

This is a collection of over 400 mathematical, statistical, and engineering subroutines and programs for the scholar, management scientist, statistician, engineer, and industrial engineer.

PROJECT MANAGEMENT

PERT, CPM, and PROJECT for management of projects consisting of many tasks and phases.

NUMERICAL CONTROL

Automatic parts generation programs for the control of automated machine tools.

TIME-SHARING LIBRARY (AVAILABLE ON RCA 3 AND RCA 7)

This library consists of Over 700 programs and subroutines for interactive and background usage. Many of the subroutines can be accessed by programs written in BASIC, FORTRAN, COBOL, or Assembly language. These programs fall into the categories of engineering, financial, management, mathematical, statistical and test of hypothesis.

SIMULATION

These packages simulate waiting lines, manufacturing processes, equipment failures and repairs, testing of decision rules for scheduling, system performance and configuration analysis.

FLOW SIMULATOR

This is a general-purpose tool used for modeling and examining the behavior of systems in the management and engineering science areas. Some examples of systems which can be simulated using the Flow Simulator are real-time systems, time-sharing systems, communication networks, traffic systems, inventory systems, and job shops.

SIMSCRIPT – SIM II PLUS

This is a general-purpose simulation language which is applicable to virtually any kind of simulation problem; both discrete and continuous. It is also a powerful non-simulation language offering many information-processing features as well as having all the elements of a scientific programming language. Much of SIMSCRIPT instruction repertoire is similar to that of FORTRAN. SIMSCRIPT has access to the entire FORTRAN mathematical library, as well as having the added advantage of using instruction inserts written in Assembly language.

SIMSCRIPT has been used effectively in building an extremely wide variety of simulation models, including models of communication networks, missile launchings, time-shared computers, job shops, computer centers, and many others. Among the applications outside of the simulation art are optimization calculations, heuristic programming, statistical analysis, data reduction and display, and business information processing.

INTEGRATED CIVIL ENGINEERING SYSTEMS (ICES)

This system, developed at MIT for civil engineering, includes subsystems for coordinate geometry, structural design, roadway analysis, transportation network, file storage, project control, and others. It is applicable to other than engineering applications because of its modular design and flexibility.

Section 10: PUBLICATIONS PLAN FOR APPLICATION PROGRAMS

Publications for Industry Applications are shown in figure 5-1. This plan describes the areas of application by industry and within each industry the programs implemented to support information processing applications in that industry. The manuals are structured so that information required by a particular level of use is grouped for easier reference.

General reader: Information manuals and brochures are for general readers such as planners, executives and management. These manuals provide an overview of a system, its components, their interrelationship, and functional descriptions.

Technical reader: Programmer's manuals, operator's guides, and program publications are intended for technical readers such as the systems analysts, programmers and operators, with detailed instructions on how to prepare for, implement, and operate a system.

These manuals are described below in further detail. The descriptions in this list are general. The contents may vary depending on the degree of detail required to understand and use the system. Not all manuals are required for every program, but the necessary user information will be contained in one or more of the following manuals.

The Application Brochure is a general information document that outlines a segment of the information processing field. It describes programs and applications by industry or part of an industry that can efficiently use modern information processing techniques.

The Application Information Manual may cover an industry, or one or more programs applicable to an industry in sufficient detail to describe the use, limitations, inputs required, processing steps, and output formats. These are covered by narrative, tables, and diagrams. The manual introduces the subject, covers the required hardware configurations, required operating system, and parameter options available under the program supplied. It references other documentation for implementation and design considerations. The Information Manual is primarily for selection of a system, and for consideration of how much of the system is applicable in a particular environment.

The Program Publication is the basic implementation manual for an application program. It describes the system, details hardware configurations, input parameters, options, processing steps and output formats. Preparation of program deck, data input, print formats are all described. Error and control messages are described with required actions. Own-coding program modifications are described, if applicable. Sample runs may be used to illustrate the application.

The Programmer's Reference Manual is a guide to the experienced programmer in how to program this particular program. The manual gives command, instruction and data formats, as well as describing the function performed, the use of registers, and usually examples. The reference manual is used for computer languages where symbolic notation is used to program, and the computer converts this to machine language and memory location assignments.

The Operator's Guide is intended primarily for use by the computer operator. It gives the configuration, channel assignments, start-up procedures, system assembling procedures, and loading procedures. Console typeouts are listed with operator corrective actions and restart procedures.

Other manuals, documents or specifications may be issued to help in informing, implementing or designing a program.

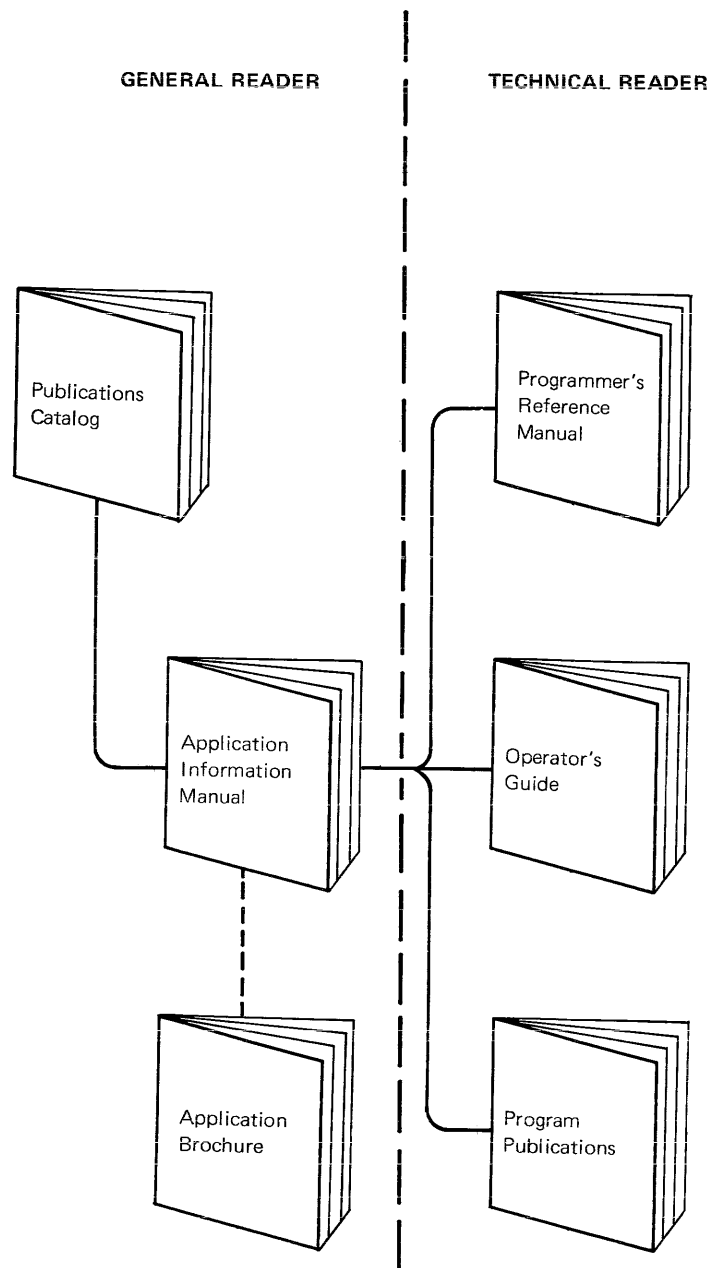

FIGURE 5-1. PUBLICATIONS PLAN FOR INDUSTRY APPLICATIONS

Appendices

APPENDIX A

EBCDIC CODES

USING THE ASSIGNED EBCDIC CHART:

To find the Hexadecimal, EBCDIC, Character Set Punch Combination, Typewriter Code and/or Paper Tape Code for any of the assigned Symbols (Printer Graphics), look within the SYMBOL column and select the desired symbol. By reading on a horizontal line across from the desired symbol all information is found. For example, if the Character Set Punch Combination for the letter O was wanted, go down the Symbol column to the letter O and horizontally across to the Character Set Punch Combination column for the answer.

The SYMBOL column acts as an index for assigned Printer Graphics.

ASSIGNED EBCDIC

| Symbol | Decimal | Hexa- decimal | EBCDIC | Character Set Punch Combination | TYPEWRITER CODES | Paper Tape Code | Symbol |
|----------|---------|------------------|-----------|---------------------------------------|---------------------|--------------------|----------|
| A | 193 | C1 | 1100 0001 | 12,1 | 1100 0001 | 1000 0001 | A |
| B | 194 | C2 | 1100 0010 | 12,2 | 1100 0010 | 1000 0010 | B |
| C | 195 | C3 | 1100 0011 | 12,3 | 1100 0011 | 1100 0011 | C |
| D | 196 | C4 | 1100 0100 | 12,4 | 1100 0100 | 1000 0100 | D |
| E | 197 | C5 | 1100 0101 | 12,5 | 1100 0101 | 1100 0101 | E |
| F | 198 | C6 | 1100 0110 | 12,6 | 1100 0110 | 1100 0110 | F |
| G | 199 | C7 | 1100 0111 | 12,7 | 1100 0111 | 1000 0111 | G |
| H | 200 | C8 | 1100 1000 | 12,8 | 1100 1000 | 1000 1000 | H |
| I | 201 | C9 | 1100 1001 | 12,9 | 1100 1001 | 1100 1001 | I |
| J | 209 | D1 | 1100 0001 | 11,1 | 1101 0001 | 1101 0001 | J |
| K | 210 | D2 | 1101 0010 | 11,2 | 1101 0010 | 1101 0010 | K |
| L | 211 | D3 | 1101 0011 | 11,3 | 1101 0011 | 1001 0011 | L |
| M | 212 | D4 | 1101 0100 | 11,4 | 1101 0100 | 1101 0100 | M |
| N | 213 | D5 | 1101 0101 | 11,5 | 1101 0101 | 1001 0101 | N |
| O | 214 | D6 | 1101 0110 | 11,6 | 1101 0110 | 1001 0110 | O |
| P | 215 | D7 | 1101 0111 | 11,7 | 1101 0111 | 1101 0111 | P |
| Q | 216 | D8 | 1101 1000 | 11,8 | 1101 1000 | 1101 0111 | Q |
| R | 217 | D9 | 1101 1001 | 11,9 | 1101 1001 | 1001 1001 | R |
| S | 226 | E2 | 1110 0010 | 0,2 | 1110 0010 | 1110 0010 | S |
| T | 227 | E3 | 1110 0011 | 0,3 | 1110 0011 | 1010 0011 | T |
| U | 228 | E4 | 1110 0100 | 0,4 | 1110 0100 | 1110 0100 | U |
| V | 229 | E5 | 1110 0101 | 0,5 | 1110 0101 | 1010 0101 | V |
| W | 230 | E6 | 1110 0110 | 0,6 | 1110 0110 | 1010 0110 | W |
| X | 231 | E7 | 1110 0111 | 0,7 | 1110 0111 | 1110 0111 | X |
| Y | 232 | E8 | 1110 1000 | 0,8 | 1110 1000 | 1110 1000 | Y |
| Z | 233 | E9 | 1110 1001 | 0,9 | 1110 1001 | 1010 1001 | Z |
| 0 (Zero) | 240 | F0 | 1111 0000 | 0 | 1111 0000 | 1111 0000 | 0 (zero) |
| 1 | 241 | F1 | 1111 0001 | 1 | 1111 0001 | 1011 0001 | 1 |
| 2 | 242 | F2 | 1111 0010 | 2 | 1111 0010 | 1011 0010 | 2 |
| 3 | 243 | F3 | 1111 0011 | 3 | 1111 0011 | 1111 0011 | 3 |

(Continued)

ASSIGNED EBCDIC

| Symbol | Decimal | Hexa-decimal | EBCDIC | Character Set Punch Combination | TYPEWRITER CODES | Paper Tape Code | Symbol |
|-------------------------------|---------|--------------|-----------|---------------------------------|------------------|-----------------|-------------------------------|
| 4 | 244 | F4 | 1111 0100 | 4 | 1111 0100 | 1011 0100 | 4 |
| 5 | 245 | F5 | 1111 0101 | 5 | 1111 0101 | 1111 0101 | 5 |
| 6 | 246 | F6 | 1111 0110 | 6 | 1111 0110 | 1111 0110 | 6 |
| 7 | 247 | F7 | 1111 0111 | 7 | 1111 0111 | 1011 0111 | 7 |
| 8 | 248 | F8 | 1111 1000 | 8 | 1111 1000 | 1011 1000 | 8 |
| 9 | 249 | F9 | 1111 1001 | 9 | 1111 1001 | 1111 1001 | 9 |
| | | | | | EOT | | |
| | | | | | ERROR | | |
| TOSL | — | — | — | — | XXXX 0101 | — | TOSL |
| CR LF | — | — | — | — | 0001 0101 | — | CR LF |
| Space | 64 | 40 | 0100 0000 | — | 0100 0000 | 1100 0000 | Space |
| ¢ (cents) | 74 | 4A | 0100 1010 | 12,8,2 | 0100 1010 | 0000 1010 | ¢ (cents) |
| . (period) | 75 | 4B | 0100 1011 | 12,8,3 | 0100 1011 | 0100 1011 | . (period) |
| < (less than) | 76 | 4C | 0100 1100 | 12,8,4 | 0100 1100 | 0000 1100 | < (less than) |
| ((open parenthesis) | 77 | 4D | 0100 1101 | 12,8,5 | 0100 1101 | 0100 1101 | ((open parenthesis) |
| + (plus) | 78 | 4E | 0100 1110 | 12,8,6 | 0100 1110 | 0100 1110 | + (plus) |
| (vertical) | 79 | 4F | 0100 1111 | 12,8,7 | 0100 1111 | 0000 1111 | (vertical) |
| & (ampersand) | 80 | 50 | 0101 0000 | 12 | 0101 0000 | 0101 0000 | & (ampersand) |
| ! (exclamation) | 90 | 5A | 0101 1010 | 11,8,2 | 0101 1010 | 0101 1010 | ! (exclamation) |
| \$ (dollar sign) | 91 | 5B | 0101 1011 | 11,8,3 | 0101 1011 | 0001 1011 | \$ (dollar sign) |
| * (asterisk) | 92 | 5C | 0101 1100 | 11,8,4 | 0101 1100 | 0101 1100 | * (asterisk) |
|) (close parenthesis) | 93 | 5D | 0101 1101 | 11,8,5 | 0101 1101 | 0001 1101 |) (close parenthesis) |
| ; (semicolon) | 94 | 5E | 0101 1110 | 11,8,6 | 0101 1110 | 0001 1110 | ; (semicolon) |
| ¬ (logical NOT) | 95 | 5F | 0101 1111 | 11,8,7 | 0101 1111 | 0101 1111 | ¬ (logical NOT) |
| - (minus) | 96 | 60 | 0110 0000 | 11 | 0110 0000 | 0110 0000 | - (minus) |
| / (slash) | 97 | 61 | 0110 0001 | 0,1 | 0110 0001 | 0010 0001 | / (slash) |
| ^ (logical AND) | 106 | 6A | 0110 1010 | 12,11 | 0110 1010 | 0110 1010 | ^ (logical NOT) |
| , (comma) | 107 | 6B | 0110 1011 | 0,8,3 | 0110 1011 | 0010 1011 | , (comma) |
| % (percent) | 108 | 6C | 0110 1100 | 0,8,4 | 0110 1100 | 0110 1100 | % (percent) |
| <u> </u> (underline) | 109 | 6D | 0110 1101 | 0,8,5 | 0110 1101 | 0010 1101 | <u> </u> (underline) |
| > (greater than) | 110 | 6E | 0110 1110 | 0,8,6 | 0110 1110 | 0010 1110 | > (greater than) |
| ? (question mark) | 111 | 6F | 0110 1111 | 0,8,7 | 0110 1111 | 0110 1111 | ? (question mark) |
| : (colon) | 122 | 7A | 0111 1010 | 8,2 | 0111 1010 | 0011 1010 | : (colon) |
| # (number sign) | 123 | 7B | 0111 1011 | 8,3 | 0111 1011 | 0111 1011 | # (number sign) |
| @ (at the rate of) | 124 | 7C | 0111 1100 | 8,4 | 0111 1100 | 0011 1100 | @ (at the rate of) |
| ' (apostrophe) | 125 | 7D | 0111 1101 | 8,5 | 0111 1101 | 0111 1101 | ' (apostrophe) |
| = (equals) | 126 | 7E | 0111 1110 | 8,6 | 0111 1110 | 0111 1110 | = (equals) |
| " (quote) | 127 | 7F | 0111 1111 | 8,7 | 0111 1111 | 0011 1111 | " (quote) |
| Gap | | | | | | | Gap |

EOT — End of Transmission
TOSL — Turn on Send Lamp
CR LF — Carriage Return Line Feed

UNASSIGNED EBCDIC

| Decimal | Hexa-decimal | EBCDIC | Character Set Punch Combination | Decimal | Hexa-decimal | EBCDIC | Character Set Punch Combination |
|---------|--------------|-----------|---------------------------------|---------|--------------|-----------|---------------------------------|
| 0 | 00 | 0000 0000 | 12,0,9,8,1 | 56 | 38 | 0011 1000 | 9,8 |
| 1 | 01 | 0000 0001 | 12,9,1 | 57 | 39 | 0011 1001 | 9,8,1 |
| 2 | 02 | 0000 0010 | 12,9,2 | 58 | 3A | 0011 1010 | 9,8,2 |
| 3 | 03 | 0000 0011 | 12,9,3 | 59 | 3B | 0011 1011 | 9,8,3 |
| 4 | 04 | 0000 0100 | 12,9,4 | 60 | 3C | 0011 1100 | 9,8,4 |
| 5 | 05 | 0000 0101 | 12,9,5 | 61 | 3D | 0011 1101 | 9,8,5 |
| 6 | 06 | 0000 0110 | 12,9,6 | 62 | 3E | 0011 1110 | 9,8,6 |
| 7 | 07 | 0000 0111 | 12,9,7 | 63 | 3F | 0011 1111 | 9,8,7 |
| 8 | 08 | 0000 1000 | 12,9,8 | | | | |
| 9 | 09 | 0000 1001 | 12,9,8,1 | 65 | 41 | 0100 0001 | 12,0,9,1 |
| 10 | 0A | 0000 1010 | 12,9,8,2 | 66 | 42 | 0100 0010 | 12,0,9,2 |
| 11 | 0B | 0000 1011 | 12,9,8,3 | 67 | 43 | 0100 0011 | 12,0,9,3 |
| 12 | 0C | 0000 1100 | 12,9,8,4 | 68 | 44 | 0100 0100 | 12,0,9,4 |
| 13 | 0D | 0000 1101 | 12,9,8,5 | 69 | 45 | 0100 0101 | 12,0,9,5 |
| 14 | 0E | 0000 1110 | 12,9,8,6 | 70 | 46 | 0100 0110 | 12,0,9,6 |
| 15 | 0F | 0000 1111 | 12,9,8,7 | 71 | 47 | 0100 0111 | 12,0,9,7 |
| 16 | 10 | 0001 0000 | 12,11,9,8,1 | 72 | 48 | 0100 1000 | 12,0,9,8 |
| 17 | 11 | 0001 0001 | 11,9,1 | 73 | 49 | 0100 1001 | 12,8,1 |
| 18 | 12 | 0001 0010 | 11,9,2 | | | | |
| 19 | 13 | 0001 0011 | 11,9,3 | 81 | 51 | 0101 0001 | 12,11,9,1 |
| 20 | 14 | 0001 0100 | 11,9,4 | 82 | 52 | 0101 0010 | 12,11,9,2 |
| 21 | 15 | 0001 0101 | 11,9,5 | 83 | 53 | 0101 0011 | 12,11,9,3 |
| 22 | 16 | 0001 0110 | 11,9,6 | 84 | 54 | 0101 0100 | 12,11,9,4 |
| 23 | 17 | 0001 0111 | 11,9,7 | 85 | 55 | 0101 0101 | 12,11,9,5 |
| 24 | 18 | 0001 1000 | 11,9,8 | 86 | 56 | 0101 0110 | 12,11,9,6 |
| 25 | 19 | 0001 1001 | 11,9,8,1 | 87 | 57 | 0101 0111 | 12,11,9,7 |
| 26 | 1A | 0001 1010 | 11,9,8,2 | 88 | 58 | 0101 1000 | 12,11,9,8 |
| 27 | 1B | 0001 1011 | 11,9,8,3 | 89 | 59 | 0101 1001 | 11,8,1 |
| 28 | 1C | 0001 1100 | 11,9,8,4 | | | | |
| 29 | 1D | 0001 1101 | 11,9,8,5 | 98 | 62 | 0110 0010 | 11,0,9,2 |
| 30 | 1E | 0001 1110 | 11,9,8,6 | 99 | 63 | 0110 0011 | 11,0,9,3 |
| 31 | 1F | 0001 1111 | 11,9,8,7 | 100 | 64 | 0110 0100 | 11,0,9,4 |
| 32 | 20 | 0010 0000 | 11,0,9,8,1 | 101 | 65 | 0110 0101 | 11,0,9,5 |
| 33 | 21 | 0010 0001 | 0,9,1 | 102 | 66 | 0110 0110 | 11,0,9,6 |
| 34 | 22 | 0010 0010 | 0,9,2 | 103 | 67 | 0110 0111 | 11,0,9,7 |
| 35 | 23 | 0010 0011 | 0,9,3 | 104 | 68 | 0110 1000 | 11,0,9,8 |
| 36 | 24 | 0010 0100 | 0,9,4 | 105 | 69 | 0110 1001 | 0,8,1 |
| 37 | 25 | 0010 0101 | 0,9,5 | | | | |
| 38 | 26 | 0010 0110 | 0,9,6 | 112 | 70 | 0111 0000 | 12,11,0 |
| 39 | 27 | 0010 0111 | 0,9,7 | 113 | 71 | 0111 0001 | 12,11,0,9,1 |
| 40 | 28 | 0010 1000 | 0,9,8 | 114 | 72 | 0111 0010 | 12,11,0,9,2 |
| 41 | 29 | 0010 1001 | 0,9,8,1 | 115 | 73 | 0111 0011 | 12,11,0,9,3 |
| 42 | 2A | 0010 1010 | 0,9,8,2 | 116 | 74 | 0111 0100 | 12,11,0,9,4 |
| 43 | 2B | 0010 1011 | 0,9,8,3 | 117 | 75 | 0111 0101 | 12,11,0,9,5 |
| 44 | 2C | 0010 1100 | 0,9,8,4 | 118 | 76 | 0111 0110 | 12,11,0,9,6 |
| 45 | 2D | 0010 1101 | 0,9,8,5 | 119 | 77 | 0111 0111 | 12,11,0,9,7 |
| 46 | 2E | 0010 1110 | 0,9,8,6 | 120 | 78 | 0111 1000 | 12,11,0,9,8 |
| 47 | 2F | 0010 1111 | 0,9,8,7 | 121 | 79 | 0111 1001 | 8,1 |
| 48 | 30 | 0011 0000 | 12,11,0,9,8,1 | | | | |
| 49 | 31 | 0011 0001 | 9,1 | 128 | 80 | 1000 0000 | 12,0,8,1 |
| 50 | 32 | 0011 0010 | 9,2 | 129 | 81 | 1000 0001 | 12,0,1 |
| 51 | 33 | 0011 0011 | 9,3 | 130 | 82 | 1000 0010 | 12,0,2 |
| 52 | 34 | 0011 0100 | 9,4 | 131 | 83 | 1000 0011 | 12,0,3 |
| 53 | 35 | 0011 0101 | 9,5 | 132 | 84 | 1000 0100 | 12,0,4 |
| 54 | 36 | 0011 0110 | 9,6 | 133 | 85 | 1000 0101 | 12,0,5 |
| 55 | 37 | 0011 0111 | 9,7 | 134 | 86 | 1000 0110 | 12,0,6 |

(Continued)

UNASSIGNED EBCDIC

| Decimal | Hexa-decimal | EBCDIC | Character Set Punch Combination | Decimal | Hexa-decimal | EBCDIC | Character Set Punch Combination |
|---------|--------------|-----------|---------------------------------|---------|--------------|-----------|---------------------------------|
| 135 | 87 | 1000 0111 | 12,0,7 | 180 | B4 | 1011 0100 | 12,11,0,4 |
| 136 | 88 | 1000 1000 | 12,0,8 | 181 | B5 | 1011 0101 | 12,11,0,5 |
| 137 | 89 | 1000 1001 | 12,0,9 | 182 | B6 | 1011 0110 | 12,11,0,6 |
| 138 | 8A | 1000 1010 | 12,0,8,2 | 183 | B7 | 1011 0111 | 12,11,0,7 |
| 139 | 8B | 1000 1011 | 12,0,8,3 | 184 | B8 | 1011 1000 | 12,11,0,8 |
| 140 | 8C | 1000 1100 | 12,0,8,4 | 185 | B9 | 1011 1001 | 12,11,0,9 |
| 141 | 8D | 1000 1101 | 12,0,8,5 | 186 | BA | 1011 1010 | 12,11,0,8,2 |
| 142 | 8E | 1000 1110 | 12,0,8,6 | 187 | BB | 1011 1011 | 12,11,0,8,3 |
| 143 | 8F | 1000 1111 | 12,0,8,7 | 188 | BC | 1011 1100 | 12,11,0,8,4 |
| 144 | 90 | 1001 0000 | 12,11,8,1 | 189 | BD | 1011 1101 | 12,11,0,8,5 |
| 145 | 91 | 1001 0001 | 12,11,1 | 190 | BE | 1011 1110 | 12,11,0,8,6 |
| 146 | 92 | 1001 0010 | 12,11,2 | 191 | BF | 1011 1111 | 12,11,0,8,7 |
| 147 | 93 | 1001 0011 | 12,11,3 | 192 | C0 | 1100 0000 | 12,0 |
| 148 | 94 | 1001 0100 | 12,11,4 | | | | |
| 149 | 95 | 1001 0101 | 12,11,5 | 202 | CA | 1100 1010 | 12,0,9,8,2 |
| 150 | 96 | 1001 0110 | 12,11,6 | 203 | CB | 1100 1011 | 12,0,9,8,3 |
| 151 | 97 | 1001 0111 | 12,11,7 | 204 | CC | 1100 1100 | 12,0,9,8,4 |
| 152 | 98 | 1001 1000 | 12,11,8 | 205 | CD | 1100 1101 | 12,0,9,8,5 |
| 153 | 99 | 1001 1001 | 12,11,9 | 206 | CE | 1100 1110 | 12,0,9,8,6 |
| 154 | 9A | 1001 1010 | 12,11,8,2 | 207 | CF | 1100 1111 | 12,0,9,8,7 |
| 155 | 9B | 1001 1011 | 12,11,8,3 | 208 | D0 | 1101 0000 | 11,0 |
| 156 | 9C | 1001 1100 | 12,11,8,4 | | | | |
| 157 | 9D | 1001 1101 | 12,11,8,5 | 218 | DA | 1101 1010 | 12,11,9,8,2 |
| 158 | 9E | 1001 1110 | 12,11,8,6 | 219 | DB | 1101 1011 | 12,11,9,8,3 |
| 159 | 9F | 1001 1111 | 12,11,8,7 | 220 | DC | 1101 1100 | 12,11,9,8,4 |
| 160 | A0 | 1010 0000 | 11,0,8,1 | 221 | DD | 1101 1101 | 12,11,9,8,5 |
| 161 | A1 | 1010 0001 | 11,0,1 | 222 | DE | 1101 1110 | 12,11,9,8,6 |
| 162 | A2 | 1010 0010 | 11,0,2 | 223 | DF | 1101 1111 | 12,11,9,8,7 |
| 163 | A3 | 1010 0011 | 11,0,3 | 224 | E0 | 1110 0000 | 0,8,2 |
| 164 | A4 | 1010 0100 | 11,0,4 | 225 | E1 | 1110 0001 | 11,0,9,1 |
| 165 | A5 | 1010 0101 | 11,0,5 | | | | |
| 166 | A6 | 1010 0110 | 11,0,6 | 234 | EA | 1110 1010 | 11,0,9,8,2 |
| 167 | A7 | 1010 0111 | 11,0,7 | 235 | EB | 1110 1011 | 11,0,9,8,3 |
| 168 | A8 | 1010 1000 | 11,0,8 | 236 | EC | 1110 1100 | 11,0,9,8,4 |
| 169 | A9 | 1010 1001 | 11,0,9 | 237 | ED | 1110 1101 | 11,0,9,8,5 |
| 170 | AA | 1010 1010 | 11,0,8,2 | 238 | EE | 1110 1110 | 11,0,9,8,6 |
| 171 | AB | 1010 1011 | 11,0,8,3 | 239 | EF | 1110 1111 | 11,0,9,8,7 |
| 172 | AC | 1010 1100 | 11,0,8,4 | | | | |
| 173 | AD | 1010 1101 | 11,0,8,5 | 250 | FA | 1111 1010 | 12,11,0,9,8,2 |
| 174 | AE | 1010 1110 | 11,0,8,6 | 251 | FB | 1111 1011 | 12,11,0,9,8,3 |
| 175 | AF | 1010 1111 | 11,0,8,7 | 252 | FC | 1111 1100 | 12,11,0,9,8,4 |
| 176 | B0 | 1011 0000 | 12,11,0,8,1 | 253 | FD | 1111 1101 | 12,11,0,9,8,5 |
| 177 | B1 | 1011 0001 | 12,11,0,1 | 254 | FE | 1111 1110 | 12,11,0,9,8,6 |
| 178 | B2 | 1011 0010 | 12,11,0,2 | 255 | FF | 1111 1111 | 12,11,0,9,8,7 |
| 179 | B3 | 1011 0011 | 12,11,0,3 | | | | |

APPENDIX B

AMERICAN NATIONAL STANDARD CODE FOR INFORMATION INTERCHANGE
(ANSII)

76X5 ← 4321 →

| HEX | → | 0 | 1 | 2 | 3 | 4 | 5 | 6 | 7 | 8 | 9 | A | B | C | D | E | F |
|-----|------|------|------|------|------|------|------|------|------|------|------|------|------|------|------|------|------|
| ↓ | | 0000 | 0001 | 0010 | 0011 | 0100 | 0101 | 0110 | 0111 | 1000 | 1001 | 1010 | 1011 | 1100 | 1101 | 1110 | 1111 |
| 0 | 0000 | NUL | SOH | STX | ETX | EOT | ENQ | ACK | BEL | BS | HT | LF | VT | FF | CR | SO | SI |
| 1 | 0001 | DLE | DC1 | DC2 | DC3 | DC4 | NAK | SYN | ETB | CAN | EM | SUB | ESC | FS | GS | RS | US |
| 2 | 0010 | | | | | | | | | | | | | | | | |
| 3 | 0011 | | | | | | | | | | | | | | | | |
| 4 | 0100 | SP | ! | " | # | \$ | % | & | ' | (|) | * | + | , | - | . | / |
| 5 | 0101 | 0 | 1 | 2 | 3 | 4 | 5 | 6 | 7 | 8 | 9 | : | ; | < | = | > | ? |
| 6 | 0110 | | | | | | | | | | | | | | | | |
| 7 | 0111 | | | | | | | | | | | | | | | | |
| 8 | 1000 | | | | | | | | | | | | | | | | |
| 9 | 1001 | | | | | | | | | | | | | | | | |
| A | 1010 | @ | A | B | C | D | E | F | G | H | I | J | K | L | M | N | O |
| B | 1011 | P | Q | R | S | T | U | V | W | X | Y | Z | [| \ |] | ^ | _ |
| C | 1100 | | | | | | | | | | | | | | | | |
| D | 1101 | | | | | | | | | | | | | | | | |
| E | 1110 | ` | a | b | c | d | e | f | g | h | i | j | k | l | m | n | o |
| F | 1111 | p | q | r | s | t | u | v | w | x | y | z | { | | } | ~ | DEL |

Bit Positions: 7 6 X 5 4 3 2 1

Significance: 2⁷ 2⁶ 2⁵ 2⁴ 2³ 2² 2¹ 2⁰

Control Characters:

- | | |
|--|--------------------------------------|
| NUL — Null | DC3 — Device Control 3 |
| SOH — Start of Heading (CC) | DC4 — Device Control 4 (stop) |
| STX — Start of Text (CC) | NAK — Negative Acknowledge (CC) |
| ETX — End of Text (CC) | SYN — Synchronous Idle (CC) |
| EOT — End of Transmission (CC) | ETB — End of Transmission Block (CC) |
| ENQ — Enquiry (CC) | CAN — Cancel |
| ACK — Acknowledge (CC) | EM — End of Medium |
| BEL — Bell (audible or attention signal) | SUB — Substitute |
| BS — Backspace (FE) | ESC — Escape |
| HT — Horizontal Tabulation | FS — File Separator (IS) |
| (punch card skip) (FE) | GS — Group Separator (IS) |
| LF — Line Feed (FE) | RS — Record Separator (IS) |
| VT — Vertical Tabulation (FE) | US — Unit Separator (IS) |
| FF — Form Feed (FE) | DEL — Delete |
| CR — Carriage Return (FE) | |
| SO — Shift Out | SP — Space (normally non-printing) |
| SI — Shift In | |
| DLE — Data Link Escape (CC) | (CC) — Communication Control |
| DC1 — Device Control 1 | (FE) — Format Effector |
| DC2 — Device Control 2 | (IS) — Information Separator |

APPENDIX C

MAGNETIC TAPE INTERCHANGEABILITY

| System | RCA Series System | | | | | Description |
|---------------|---------------------|----------------------------|-----------------|-----------------------|-----------------|--|
| | Tape Unit | Tape Unit | Tape Controller | Required Features For | | |
| | | | | Tape Unit | Tape Controller | |
| 301/3301 | 3484 } 3485 } ←→ | { 8432 { 8442 { 8445 | 8473 | 5411 5412 5413 | None | 301-EBCDIC translation by program only. Controller can handle an intermix of 7-track and 9-track Tape Units. Feature 5402 (pack/unpack for 7-track tape) optional. Available as a single channel (1x8 or 1x16) or dual channel (2x8 or 2x16) control. Features 5411, 5412, and 5413 modify their respective Tape Units for 7-track operation. Feature 5463 is available to modify the 8445 Tape Station, 7-track or 9-track to permit an "Automatic Load" Function. |
| IBM 7000/1400 | 727 } 729 } ←→ | { 8432 { 8442 { 8445 | 8473 | 5411 5412 5413 | None | Controller can provide direct BCD-EBCDIC translation and handles an intermix of 7-track and 9-track Tape Units. Feature 5402 (pack/unpack for 7-track tape) optional. Also available, is feature 5464 which converts one of the two drives in a Model 8442 from the standard 9-track format to the 727/729 7-track tape format, leaving the other drive unchanged as 9-track. Feature 5465 is same as above, except it applies to 8432 drives. Feature 5450 (Word Mark) is available to modify the controller to operate with the 1401/1410, or 1410 only emulators. Available as a single channel (1x8 or 1x16) or dual channel (2x8 or 2x16) control. Features 5411, 5412, and |

(Continued)

| System | RCA Series System | | | | | Description |
|------------|-------------------|----------------------------|-----------------|-----------------------|-----------------|--|
| | Tape Unit | Tape Unit | Tape Controller | Required Features For | | |
| | | | | Tape Unit | Tape Controller | |
| IBM360/370 | 2401,-1 2, 3. | ↔ { 8432 8442 8445 } | 8472 | None None None | None | 5413 modify their respective tape units for 7-track tape. Feature 5463 is available to modify the 8445 Tape Station, 7- or 9-track to permit an "Automatic Load" function. |
| | 2404,-4 5, 6. | ↔ { 8451 8453 } | 8476 | None | | 1600 BPI phase-encoding controller with Feature 5431 800 BPI 9-track NRZ or 1600 phase-encoding can be accommodated; available as a single-channel (1x8 or 1x16) or dual-channel (2x8 or 2x16) control. However, a maximum of eight NRZ Tape Units is permitted on any controller. Feature 5452 (Word Mark) modifies the controller to operate with the 1401/1410, or 1410 only emulators. |
| | 2420-5, 7. | ↔ { 8432 8442 8445 } | | | 5431 | |
| | 2401-4, 5, 6. | ↔ { 8457 8459 } | 8478 | None | None | 1600 BPI phase-encoding controller available as a single-channel (1x8 or 1x16) or dual-channel (2x8 or 2x16). |

APPENDIX D

RCA 2, 3, 6, and 7 CONFIGURATOR

| | RCA 2 | RCA 3 | RCA 6 | RCA 7 |
|--|-----------|-----------|---|---|
| MAIN MEMORY SIZE (KILOBYTES) | | | | |
| 65 | X | | | |
| 131 | | X | X | |
| 196 | | | | |
| 262 | X | X | X | X |
| 393 | | | X | X |
| 524 | | | X | X |
| 655 | | | X | X |
| 786 | | | X | X |
| 917 | | | X | X |
| 1048 | | | X | X |
| 1310 | | | X | X |
| 1572 | | | X | X |
| 1835 | | | X | X |
| 2097 | | | X | X |
| CYCLE | | | | |
| Bytes Transferred | 2 | 2 | 4 | 4 |
| Speed us | 1.44 | 1.44 | 0.765 | 0.765 |
| SPECIAL FEATURES | | | | |
| CONSOLE | X | X | X | X |
| DIRECT CONTROL | X | X | X | X |
| MEMORY EXPANSION | | | X | X |
| EMULATORS | 1401 | 1401 | 1401 1410/7010 RCA 301 RCA 501 | 1401 1410/7010 RCA 301 RCA 501 |
| MEMORY PROTECT | | | | |
| Write | X | X | X | X |
| Write and Read | X | X | X | X |
| SELECTOR CHANNELS | | | | |
| (Max.) | 4 | 4 | 6 | 6 |
| I/O CHANNELS | | | | |
| SELECTORS | 2, 3 OR 4 | 2, 3 OR 4 | 2, 3, 4, 5 OR 6 | 2, 3, 4, 5 OR 6 |
| TRUNKS PER SEL. CHANNEL (MAX.) | 2 | 2 | 3 | 3 |
| TRUNKS ON MUX | 9 | 9 | 16 | 16 |
| TOTAL TRUNKS (MAX.) | 17 | 17 | 34 | 34 |
| DEVICES ON MUX (MAX.) | 256 | 256 | 248 | 248 |
| I/O TRANSFER RATE (Kb PER SECOND) | | | | |
| EACH SELECTOR | 694 | 694 | 900 | 900 |
| MAX. SELECTORS | 1388 | 1388 | 5240 | 5240 |
| MUX | 72 | 72 | 216 | 216 |
| BYTES PER SELECTOR CHANNEL TRANSFER | 2 | 2 | 4 | 4 |

CONSOLE DEVICES

- 8091 Video Operator Console
- 8092 Auxiliary Console
- 8093 Console Printer
- 8094 Console Card Reader
- 8097-020 Console
- 8221 Paper Tape Reader/Punch
- 8224 Paper Tape Reader
- 8227 Paper Tape Reader/Punch

CARD AND MICR DEVICES

- 8232 Card Reader
- 8234 Card Punch
- 8236 Card Punch
- 8237 Card Reader
- 8272 MICR Controller
- 8242 Printer—Medium Speed
- 8243 Printer—High Speed
- 8244 Hi-Speed Printer
- 8248 Bill Feed Printer
- 8249 Bill Feed Controller

SWITCHING DEVICES

- 8310 Standard Interface Switch
- 8350 Switch Controller
- 8325-002 Telegraph Switch Unit
- 8326-002 Data Set Switch Unit
- 8356 Communications Line Switch Adaptor
- 8551 Random Access Controller
- 8560 Virtual Memory Storage Unit
- 8564 Disc Storage Unit
- 8567 Drum Memory Units
- 8568 Mass Storage Unit
- 8590 Direct Access Storage System

RANDOM ACCESS DEVICES

PRINTER DEVICES

MAGNETIC TAPE DEVICES

| Controllers | Tape Units | | | | | | | | | | Tape Stations | | |
|-------------------------------------|------------|----------|----------|----------|----------|----------|----------|----------|----------|----------|---------------|------|------|
| | 8432-001 | 8432-002 | 8441-002 | 8442-001 | 8442-002 | 8451-001 | 8451-002 | 8453-001 | 8453-002 | 8445-001 | 8445-002 | 8457 | 8459 |
| 8472-108 Single Channel (9 track) | 4 | | | 4 | | | | | | 8 | | | |
| 8472-116 Single Channel (9 track) | 8 | | | 8 | | | | | | 16 | | | |
| 8473-108 Single Channel (7/9 track) | 4 | | | 4 | | | | | | 8 | | | |
| 8473-116 Single Channel (7/9 track) | 8 | | | 8 | | | | | | 16 | | | |
| 8472-208 Dual Channel (9 track) | | 4 | | | 4 | | | | | | 8 | | |
| 8472-216 Dual Channel (9 track) | | 8 | | | 8 | | | | | | 16 | | |
| 8473-208 Dual Channel (7/9 track) | | 4 | | | 4 | | | | | | 8 | | |
| 8473-216 Dual Channel (7/9 track) | | 8 | | | 8 | | | | | | 16 | | |
| 8476-108 Single Channel (9 track) | *4 | | | *4 | | 4 | | 4 | *8 | | | | |
| 8476-116 Single Channel (9 track) | *4 | | | *4 | | 8 | | 8 | *8 | | | | |
| 8476-208 Dual Channel (9 track) | *4 | | | *4 | | 4 | | 4 | *8 | | | | |
| 8476-216 Dual Channel (9 track) | *4 | | | *4 | | 8 | | 8 | *8 | | | | |
| 8478-108 Single Channel (9 track) | | | | | | | | | | 8 | 8 | | |
| 8478-116 Single Channel (9 track) | | | | | | | | | | 16 | 16 | | |
| 8478-208 Dual Channel (9 track) | | | | | | | | | | 8 | 8 | | |
| 8478-216 Dual Channel (9 track) | | | | | | | | | | 16 | 16 | | |

COMMUNICATIONS CONTROLLER AND BUFFERS

- 8510 Voice Response Unit
- 8627 Data Exchange Control
- 8653 Communication Control (Single Channel)
- 8656 Communication Control (Single-Channel)
- 8660 Front End Communication Controller
- 8668 Communication Controller Multichannel
- 8610 Telegraph Buffer
- 8612 Telegraph Low Level Buffer
- 8615 Telegraph Parallel Buffer
- 9617 Parallel Data Set Buffer
- 8620 Asynchronous Data Set Buffer
- 8621 Synchronous Data Set Buffer
- 8680 Time Generator Buffer

TERMINALS AND ASSOCIATED DEVICES

- Modular Video Data System**
- 8751 Video Data Terminal
- 8756 Video Data Generator
- 8759 Video Data Controller (Mux Trunk only)
- Stand-Alone Video Data Terminals**
- 8752-100 Video Data Terminal
- 8752-200 Video Data Terminal
- 8755-100 Video Data Switch
- 8755-200 Data Terminal Switch
- Other Terminals and Associated Devices**
- 8740 Data Terminal
- 8741 Card Reader
- 8762 Data Terminal
- 6701 Data Terminal Coupler
- 6711 Data Set
- 6740, 6741, 6742 Teletypewriters
- 6793 Power Supply
- 6750, 6751, 6752 Teletypewriters

COMMUNICATIONS CONFIGURATOR

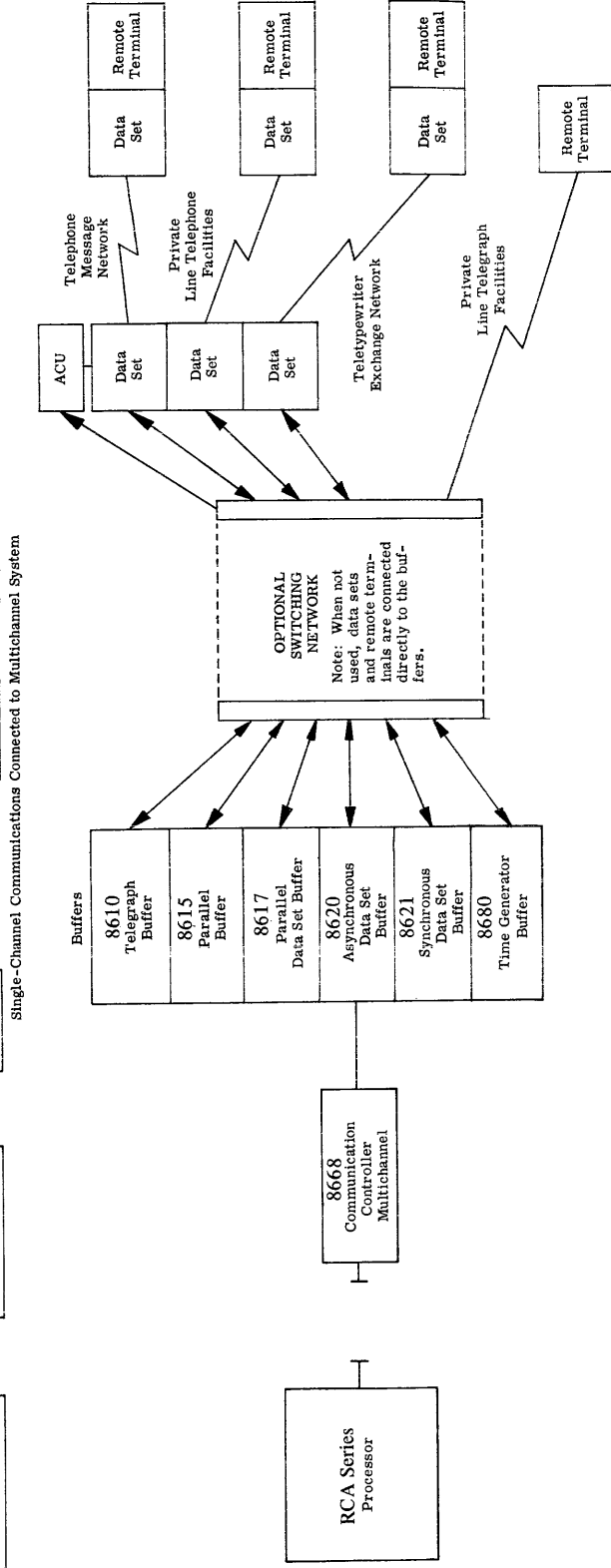
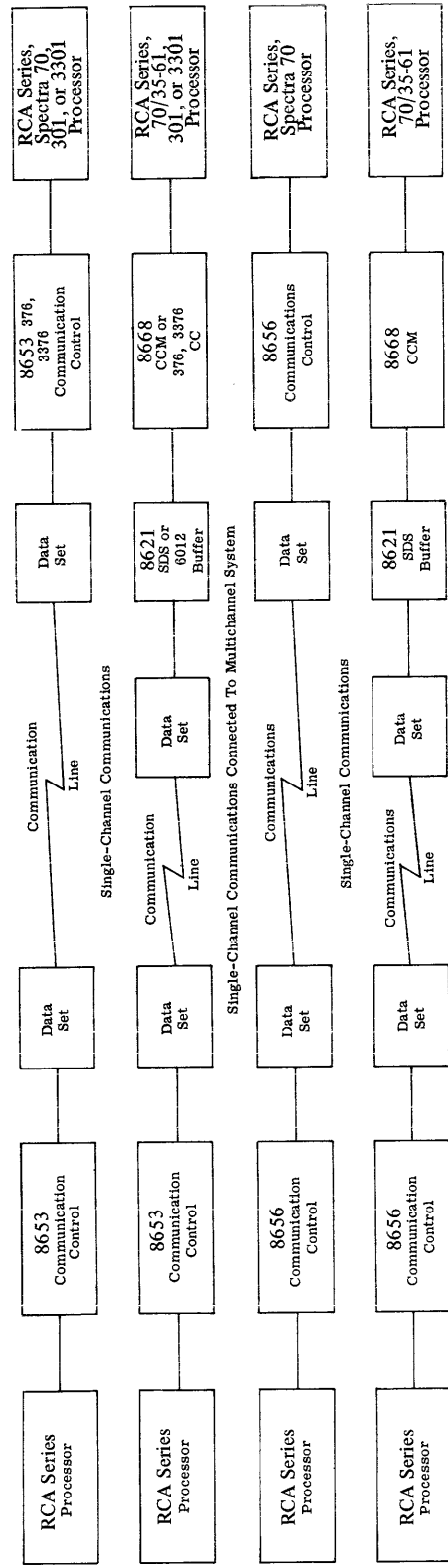

Multichannel Communication System

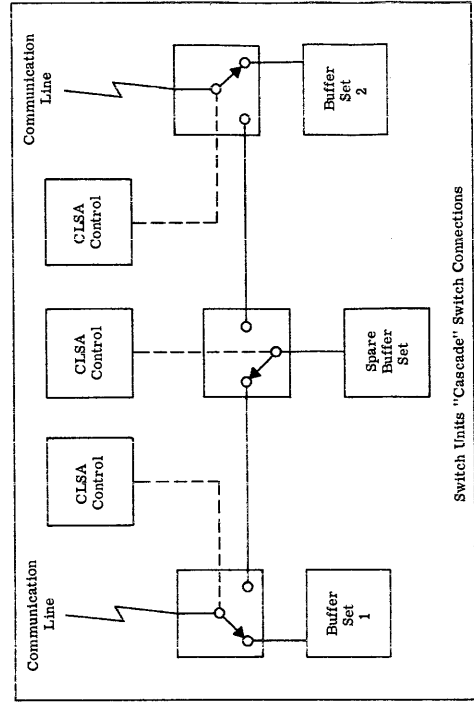

Note: This diagram illustrates a cascade connection which consists of several "ganged" switches separately controlled. A typical cascade connection permits two sets of communication lines to share access to a spare buffer.

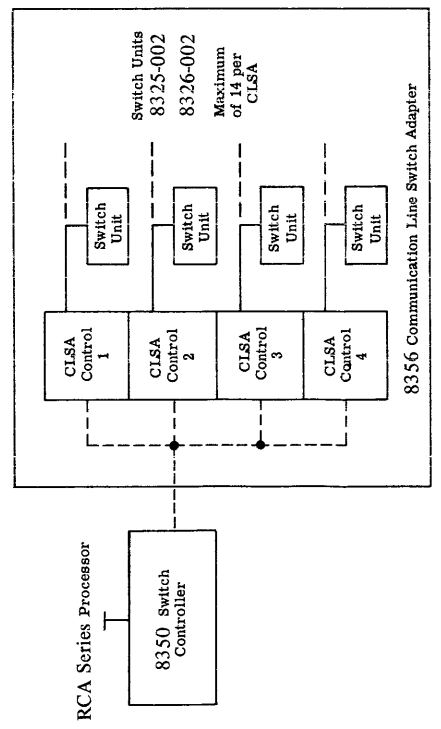

Note: The 8350 Switch Controller and associated 8310 are connected to the 8356 and CLSAs only under those circumstances where direct program control of the CLSAs is required.

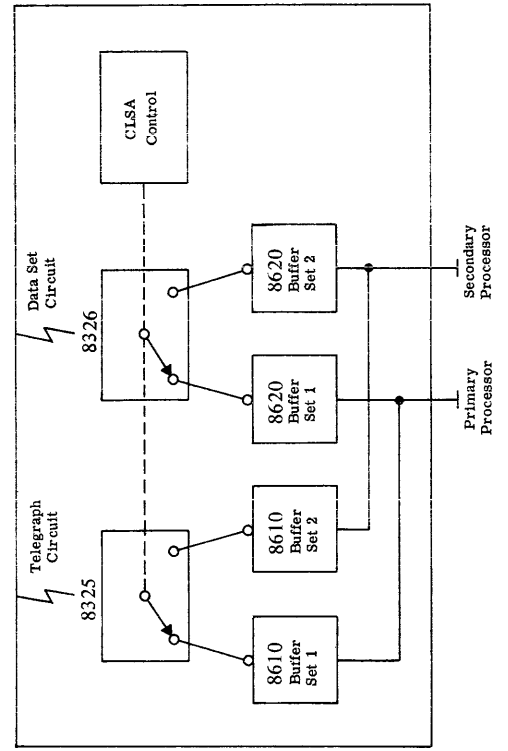

Note: This diagram shows how switch units select one of two sets of buffers which are normally associated with different CCMs. The equipment arrangement is that of a "ganged" switch.

RCA 6701 DATA TERMINAL CONFIGURATIONS

This appendix shows various ways in which the RCA Terminals can be connected to the RCA 6701. Both Uncontrolled (free-running terminal initiated) transmission and Controlled (processor polled or called) modes of operation may be accommodated on the RCA 6701.

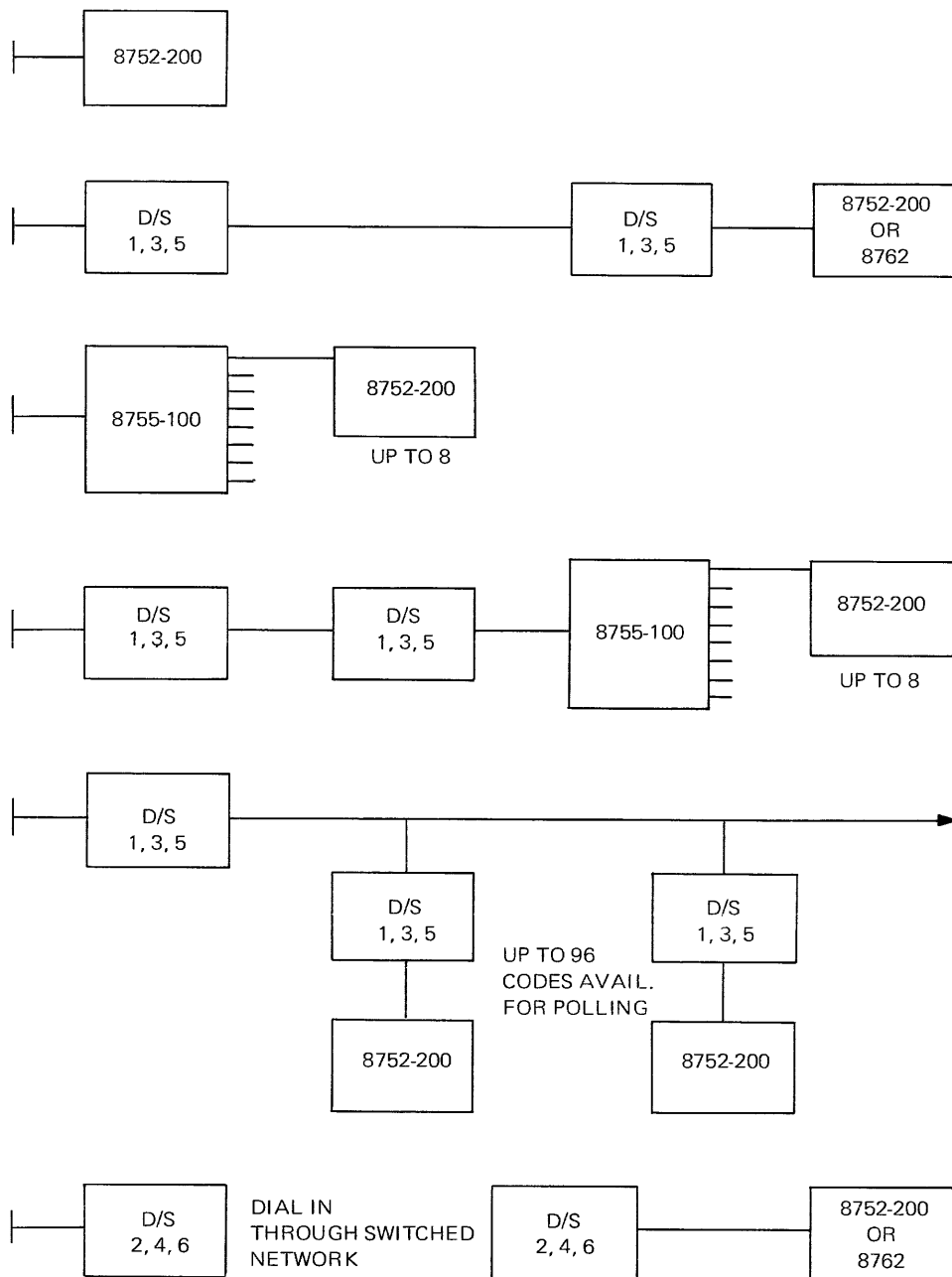

NOTE 1

DATA SETS

- D/S 1 BELL SYSTEM 103F OR EQUAL
- D/S 2 BELL SYSTEM 103A OR EQUAL
- D/S 3 RCA 6711 OR BELL SYSTEM 202D OR EQUAL
- D/S 4 BELL SYSTEM 202C OR EQUAL
- D/S 5 BELL SYSTEM 201B OR EQUAL
- D/S 6 BELL SYSTEM 201A OR EQUAL

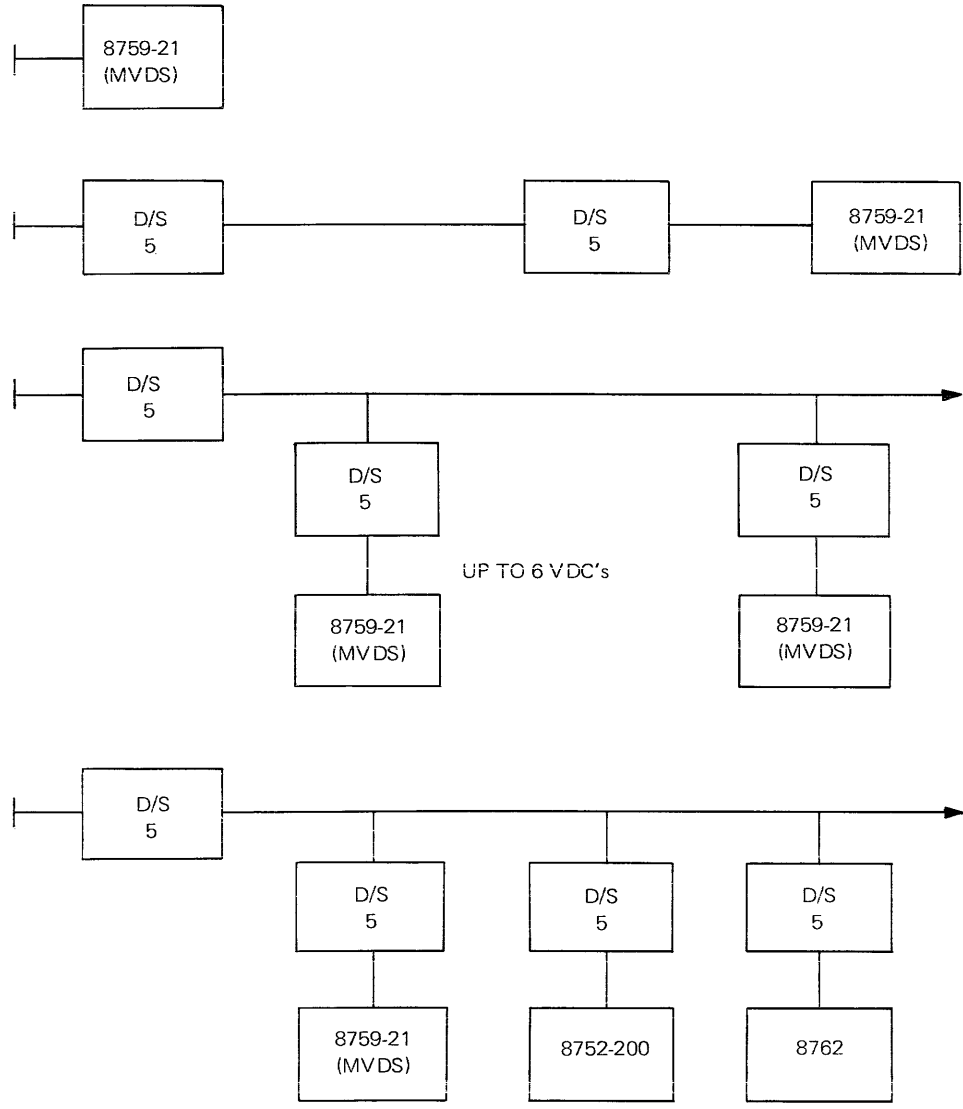

NOTE 1 DATA SETS

D/S 5 BELL SYSTEM 201B OR EQUAL

NOTE 2

CONFIGURATIONS DEPICTED IN THIS FIGURE OPERATE IN THE FULL DUPLEX MODE.

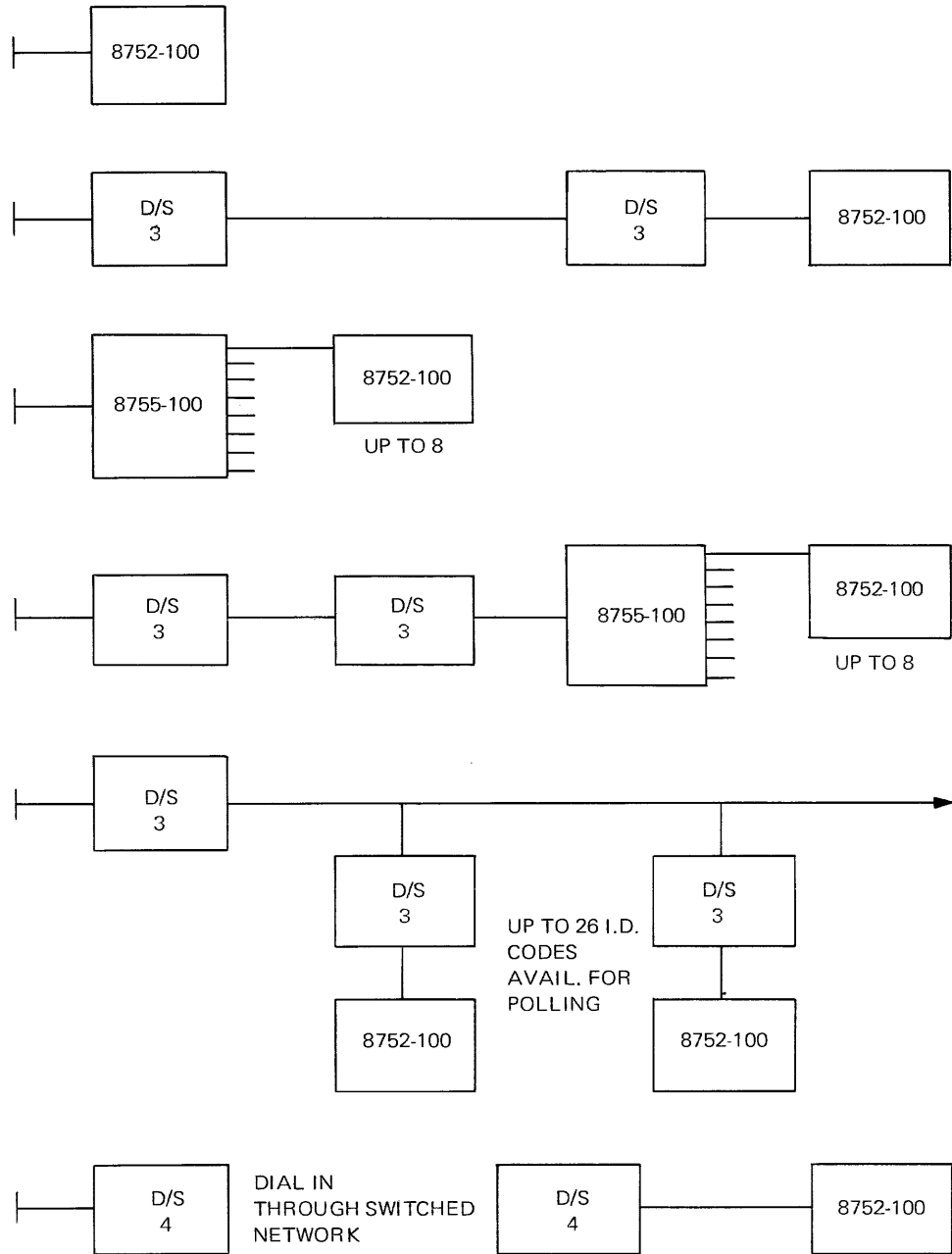

NOTE 1 DATA SETS

D/S 3 = RCA 6711 OR BELL SYSTEM 202D OR EQUAL
 D/S 4 = BELL SYSTEM 202C OR EQUAL

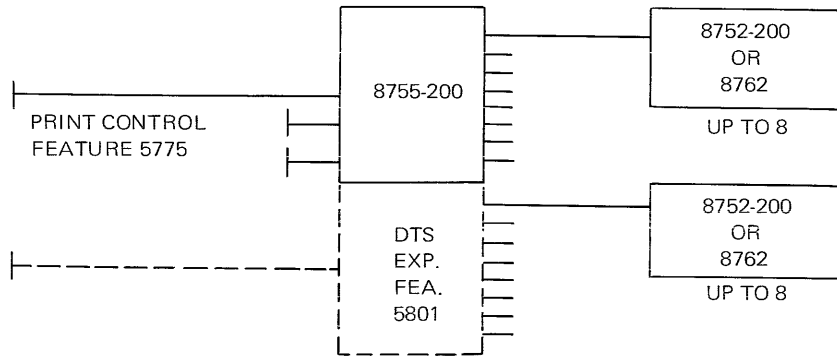

NOTE 1

ASYNCHRONOUS ONLY, 2400 BPS.

NOTE 2

EXPANSION FEATURE PERMITS UP TO 16 TERMINALS ON ONE LINE CONNECTION, OR SPLIT QUANTITIES ON TWO LINE CONNECTIONS. IN CASE OF FAILURE OF ONE LINE CONNECTION, ALL TERMINALS CAN BE SWITCHED TO THE OTHER LINE CONNECTION'

NOTE 3

DETAILS OF 8755-200 DATA TERMINAL SWITCH AND CAPABILITIES OPERATION ARE FOUND IN THE PRODUCT ANNOUNCEMENT FYI #6-3.

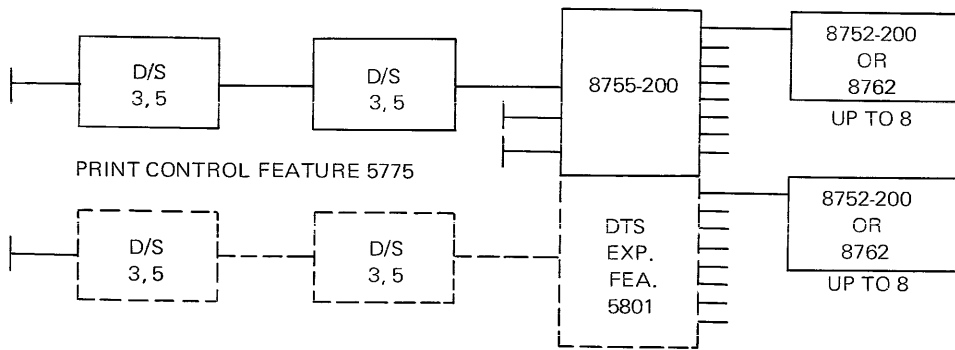

NOTE 1 DATA SETS

D/S 3 = RCA 6711 OR BELL SYSTEM 202D OR EQUAL

D/S 5 = BELL SYSTEM 201B OR EQUAL

NOTE 2

EXPANSION FEATURE PERMITS UP TO 16 TERMINALS ON ONE LINE CONNECTION, OR SPLIT QUANTITIES ON TWO LINE CONNECTIONS' IN CASE OF FAILURE OF ONE LINE CONNECTION, ALL TERMINALS CAN BE SWITCHED TO THE OTHER LINE CONNECTION.

NOTE 3

8755-200's MAY BE MULTIPOINTEDED ON A CIRCUIT AND MAY BE INTERMIXED WITH 8759-021's AND SINGLE 8752-200's AND 8762's.

Title RCA Series Systems Information Manual



Document No. BF-000-1-00

Date December 1970

Your comments and suggestions will help us to furnish publications that are more useful to you.

Is this publication:

Complete in its coverage?

Logically organized?

Technically accurate?

Easy to understand?

Other Comments (Use additional page if necessary).

Name _____ Street or Box No. _____

Job Title _____ City _____

Company _____ State _____ Zip _____

Staple

Staple

Cut Along Line

Fold

FIRST CLASS
PERMIT NO. 16
CAMDEN, N. J.

BUSINESS REPLY MAIL – no postage necessary if mailed in the United States

Postage will be paid by addressee

RCA | COMPUTER SYSTEMS DIVISION
CHERRY HILL, 204-2
CAMDEN, N. J. 08101

ATTN: Publication Services

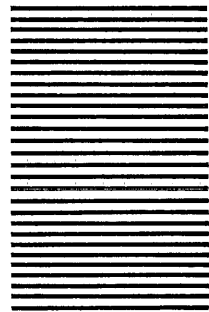

Fold

**Publications
Purchase
Order**

RCA|Computer Systems Division
Camden, N. J. 08101

Order Number



| Item No. | Quantity Ordered | Ordering Number | Description or Title of Material | Complete if Publications Are To Be Purchased | |
|---|------------------|-----------------|---|---|--------|
| | | | | Unit Price | Totals |
| 1 | | | | | |
| 2 | | | | | |
| 3 | | | | | |
| 4 | | | | | |
| 5 | | | | | |
| 6 | | | | | |
| 7 | | | | | |
| 8 | | | | | |
| 9 | | | | | |
| 10 | | | | | |
| 11 | | | | | |
| 12 | | | | | |
| 13 | | | | | |
| 14 | | | | | |
| 15 | | | | | |
| 16 | | | | | |
| Ship To: | | | Bill To: (Complete if Publications Are To Be Purchased) | Sub Total | |
| | | | | Indicate Applicable Sales Tax | |
| | | | | Total Cost | |
| | | | | Check Appropriate Block: | |
| | | | | Bill My Company | |
| | | | | Remittance Enclosed | |
| | | | | If Publications are to be purchased forward this Form and any enclosures to: | |
| | | | Customer P.O. # | RCA Computer Systems Division Reproduction Services Camden, N. J. 08101 | |
| Publications purchased will be furnished subject to all terms and conditions stated on the reverse side of this Form. | | | | | |
| Ship via | | | Date Required | | |
| Authorized Signature | | | Date | | |
| | | | | All other requests: Forward this form to the nearest RCA District Office. | |

Terms And Conditions
Applicable To The Sale of RCA Publications and Forms



PRICES

All prices are subject to change or withdrawal without notice and all shipments will be billed at prices in effect on date of shipment. Unless otherwise specified or required by law, all prices will be billed exclusive of state and local sales and similar taxes, and such taxes will appear as additional items on invoices.

TRANSPORTATION

All shipments will be f.o.b. destination.

On shipments where Purchaser requests transportation involving expenses beyond those involved on transportation normally selected by RCA, the Purchaser will be responsible for payment of such extra costs.

RCA reserves the right to ship from any location subject to the foregoing transportation terms.

DELIVERIES

It is the desire of RCA to meet requested delivery schedules. However, RCA shall not incur any liability due to any delay or failure to deliver for any reason. Any delivery indication furnished by RCA only represents the best estimate of the time required to make shipment. The delivery of part of any order shall not obligate RCA to make further deliveries, and RCA reserves the right to decline servicing any order in whole or in part.

Of necessity, inventories and current production must be allocated in such a manner as to comply with applicable Government regulations. In the absence of such regulations, RCA reserves the right to allocate inventories and current production when, in its opinion, such allocation is necessary.

TERMS OF PAYMENT

Invoices shall be rendered at time of shipment and shall be payable net 30 days from date of shipment.

Partial shipments will be invoiced as made, and payments therefor are subject to the above terms.

GENERAL

In no event shall RCA be liable for indirect, consequential or special damages.

Information furnished by RCA is believed to be accurate and reliable. However, no responsibility is assumed by RCA for its use; nor for any infringements of patents or other rights of third parties which may result from its use. No license is granted by implication or otherwise under any patent or patent rights of RCA.

This Agreement shall be governed by the laws of the State of New York and constitutes the entire Agreement between the parties with respect to the subject matter hereof. It shall prevail regardless of any variation in the terms and conditions of any other submitted by the Purchaser.